



# CATALOG 2023

# THE RIGHT PRODUCT FOR YOU ORDER ONLINE 24/7

A clear structure together with intelligent search functions lead you on the shortest path to the best product solution for your automation task.

## Up-to-date prices and availability in real time

**Fork light barrier OGU with LED**  
**OGU 050 G3-T3**  
Article Number: 210248

The OGU series with an LED light source is the standard among fork light barriers. The largest range of fork light barriers on the market includes devices with fork openings from 5 mm to 250 mm. OGU fork light barriers offer high resolution and reproducibility with formidable speed. They are operated intuitively using potentiometers, teach-in or IO-Link. Four preset operation modes provide the option for ideal adaptation to the application. At the same time, IO-Link offers important advantages in configuration and diagnosis.

- 4 operating modes as an IO-Link parameter
- Switch-on/off delay as an IO-Link parameter
- Diagnostics with IO-Link
- Metal casing
- Sensitivity is adjustable
- High switching frequency
- Light/dark switching
- Bright ring LED
- High protection type
- 5-year warranty

List price: €198,00  
Your discount: 81%  
Your price: €4178,80  
Availability: ■ ex warehouse

Price net plus VAT and shipping

Electrical features	Value
Service voltage	10 ... 30 V DC
No-load current (max.)	30 mA
Insulation voltage endurance	500 V

Mechanical features	Value
Leg length internal	55 mm
Housing dimensions	70 x 80 x 10 mm

## Convenient product selectors

**Fork light barriers**

di-soric fork light barriers operate on the functional principle of through-beam sensors. They are delivered ready to install and do not have to be adjusted afterward. Fork light barriers are used wherever small objects or object positions must be detected quickly, precisely and with any type of surface.

**Selector:**

Series: Fork opening: Leg length internal: Light source:  
Light color: Sensitivity adjustment: Resolution: Switching output:  
Interface:

Relevant products 6

Fork opening: 50 mm Interface: IO-Link Reset all

Product	Series	Fork opening	Light source	Resolution	Dimensions
OGU 050 G3-T3	OGU	50 mm	LED	0,3 mm / 0,2 mm / 1,0 mm / 0,3 mm	70 x 80 x 10 mm
OGU 051 G3-T3	OGU	50 mm	LED	0,3 mm / 0,2 mm / 1,0 mm / 0,3 mm	70 x 80 x 10 mm
OGUP 060 G3-T3	OGUP Dm-resistant	50 mm	LED	0,3 mm / 0,2 mm / 2,0 mm / 0,3 mm	70 x 80 x 10 mm
OGUL 051 G3-T3	OGUL Laser	50 mm	Laser	0,03 mm / 0,03 mm / 5,1 mm / 0,03 mm	70 x 80 x 10 mm
OGUL 051 G3-T3/4A	OGUL Laser	50 mm	Laser	0,03 mm / 0,03 mm /	70 x 80 x 10 mm

## YOUR ADVANTAGES— JUST A CLICK AWAY

### Get to the proper product quickly

- Up-to-date prices and availability in real time
- Convenient product selectors
- Fast, intelligent auto-suggest search
- Clear product series with background information
- Matching accessories and the ability to download technical documents and software directly at the article
- Comfortable product comparison

### Easy ordering in the webshop

- Display of customer-specific pricing
- Display of current availability
- All of your orders at a glance with a reordering functionality
- Up-to-date product change information for your products
- Payment via invoice and credit card

Register now:  
[www.di-soric.com](http://www.di-soric.com)

www.di-soric.com

## Fast, intelligent auto-suggest search



## Product comparison with display of differences

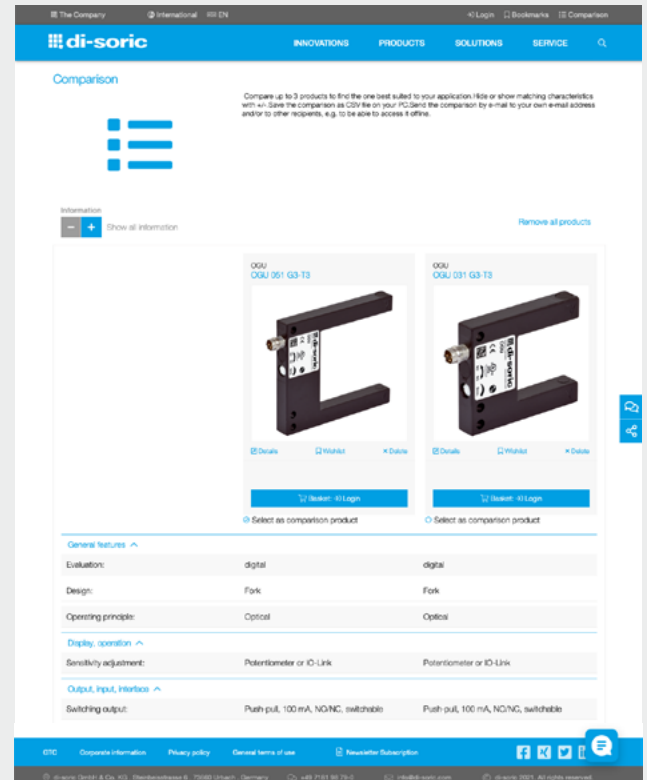

## SOLUTION-ORIENTED CONSULTATION

You would like to be consulted on our products and solutions or have questions on commercial or technical issues? Here you will find competent contact persons for all these areas.

### Commercial Customer Service

+49 7181 9879 - 710  
customer-service@di-soric.com

- Find price information and check availability
- Order processing and information
- Personal assistance
- Document request
- Shipment of samples

Mon - Thu: 8:00 - 17:00 h, Fri: 8:00 - 16:00 h

### Technical Customer Service

+49 7181 9879 - 700  
service@di-soric.com

- Product consultation
- Application support and solutions
- Experienced technical personnel
- Product recoding

Mon - Thu: 8:00 - 16:00 h, Fri: 8:00 - 14:00 h

# WELCOME TO DI-SORIC

## ABOUT THE INVENTOR OF THE FORK LIGHT BARRIER: DI-SORIC.

For over 40 years, di-soric GmbH & Co. KG has been producing and selling sensors featuring a wide variety of technologies. These sensors are used in industrial automation—primarily in assembly and handling technology, in the automotive, electronics and pharmaceutical industries and in packaging technology. Other important cornerstones of our product range are innovative vision sensors and code readers, high-quality LED lighting for machines and image processing, and products from the segment of safety technology.

Our own ambition is to benefit you. When we develop products and solutions to handle your tasks, we always strive to make them both as simple and as practical as possible.

We draw upon our high level of technical know-how and a clear view of the developments of tomorrow to support our customers – today and in the future – with precise, non-disruptive and efficient production processes.





## DI-SORIC FACTS

■ **100% OWNER-MANAGED**

■ **HEADQUARTERS**

Urbach, Germany

■ **TECHNOLOGY AND PRODUCTION CENTER**

Lüdenscheid, Germany

■ **REPRESENTATIVES AND BRANCH OFFICES**

in more than 40 countries

■ **CERTIFICATIONS**

IQNet, ISO 9001:2015, ISO 14001:2015

**OUR PROMISE TO YOU:**

**SOLUTIONS.**  
**CLEVER.**  
**PRACTICAL.**



**SOLUTIONS.**

**To us, finding solutions means  
providing you with exactly the right solution  
for the job.**

- Solution-oriented consultation and implementation
- Product portfolio for numerous application areas



## CLEVER.

To us, being clever means **finding new, smart, unconventional and therefore more effective solutions.**

- Added value for product and application
- Efficient in function and application
- Openness and flexibility for the best solutions

## PRACTICAL.

To us, being practical means **being available, taking a straightforward approach and communicating as partners.**

- Solution-oriented consultation and technical expertise
- Straightforward, cooperative and dynamic approach
- Address what is important and forget about unnecessary factors.

## A / Sensors



<b>Inductive sensors</b>	<b>8</b>
Inductive proximity sensors	8
Inductive ring sensors	38
Inductive tube sensors	44
<b>Optical sensors</b>	<b>46</b>
Light barriers and diffuse sensors	46
Optical distance sensors	60
Fork light barriers	66
Angled light barriers	74
Frame light barriers	78
Light curtains	80
High performance light barriers	88
Plastic fiber-optic sensors	92
Glass fiber-optic sensors	102
Color sensors	108
Contrast sensors	110
<b>Ultrasonic sensors</b>	<b>112</b>
Ultrasonic barriers/sensors	113
Ultrasonic fork sensors	117
<b>Capacitive proximity sensors</b>	<b>118</b>
<b>Label sensors</b>	<b>124</b>
<b>Magnetic field sensors</b>	<b>128</b>
<b>Special sensors</b>	<b>132</b>

## B / Image processing & identification



<b>Vision sensors</b>	<b>136</b>
<b>Profile sensors</b>	<b>140</b>
<b>nVision Software</b>	<b>142</b>
<b>Handheld ID readers</b>	<b>144</b>
<b>Lenses</b>	<b>148</b>
<b>Lighting for industrial image processing</b>	<b>152</b>



## C / Machine lighting & signal lights



Machine & signal lighting	164
Signal lights	168

## D / Safety technology



Opto-electronic safety sensors	172
Reliable control components	188

## E / Accessories



Connection technology	194
Signal preparation	202
Universal mounting technology	206
Test & parameterization devices	216
Sensor accessories	220
Accessories for image processing & identification	228
Accessories for machine lighting & signal lights	236
Safety technology accessories	238

## Inductive proximity sensors

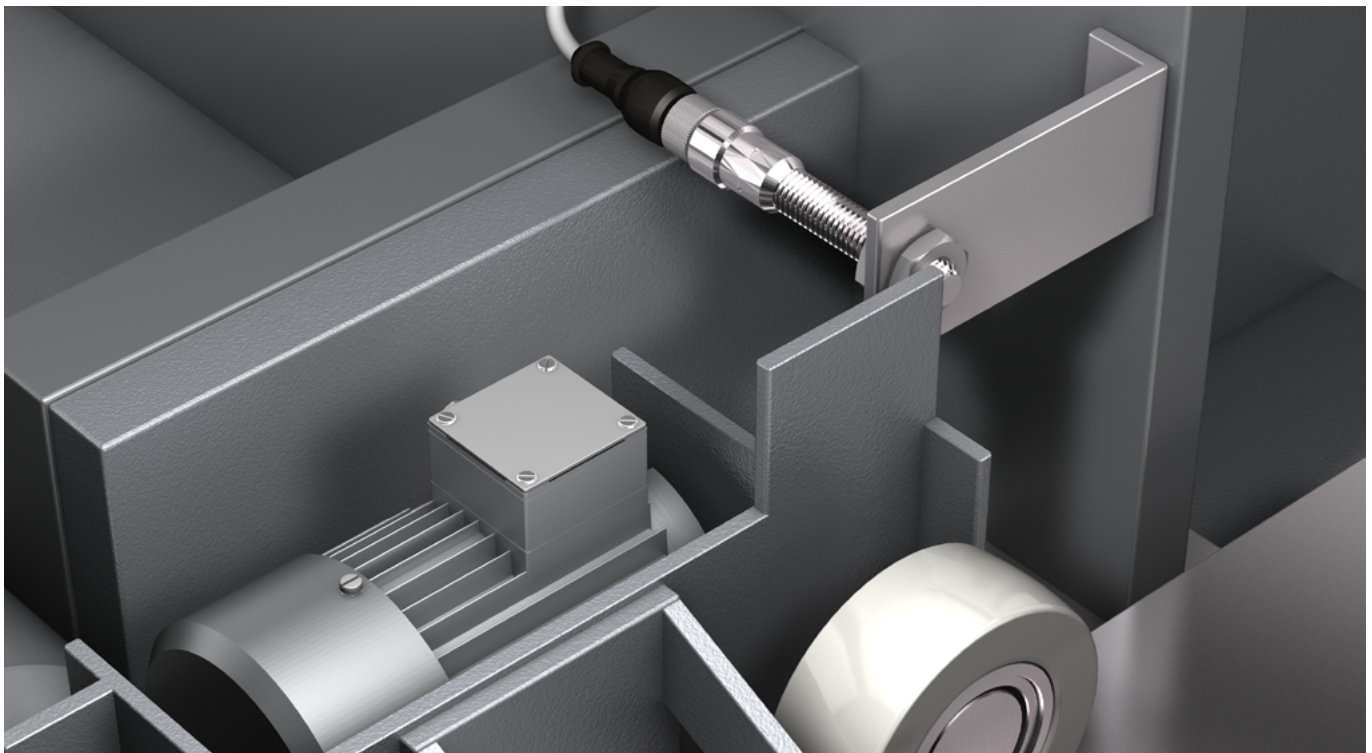

Our inductive proximity sensors are available in Ø 3 mm to M30 models as well as rectangular designs from miniature up to 40 x 40 mm. Fully metallic versions, pressure-resistant sensors up to 500 bar, as well as up to 3x or 4x switching distances supplement our product range, in addition to sensors with an analog output for precise production or testing processes. We are continually making developments to our portfolio to offer our customers real added value in a digitized industrial environment.



 **di-soric**

INS-100 Standard	9
INS-200 Standard 2-Sn	11
INM-100 Miniature	14
INM-300 Miniature Extended	16
INE Extended	18
INC Advanced	25
INW Full Metal Extended	26
INP High-pressure resistant	29
INA Analog	30
INH High-temperature resistant	31
INF Food & Beverage	32
INN Namur	34
INU Universal Voltage	35
INZ Special Applications	36

## INS-100 STANDARD

Our INS-100 Standard series impresses with its outstanding price-performance ratio in many standard industrial applications.

These proximity sensors are equipped with a simple switching distance and are available in the standard lengths of Ø 6.5 mm to M30 and rectangular-shaped in 8 x 8 mm.

Both devices are available with a high-quality PVC cable and sensors with a M8 or M12 plug connection as connection variants.

Technical data (typ.)		+20 °C, 24 VDC
Installation instructions		flush (f) / non-flush (nf) (see page 37)
For more information, visit		www.di-soric.com

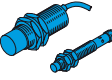
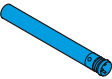

	Housing design Size (mm)	Switching distance (mm)	flush (f) / non-flush (nf) / quasi-flush (qf)	Switching output	Housing material	Cable length, plug connector	Product description
<b>INS-100 Standard, Thread design</b>							
	M8 x 45	1	f	NC, 200 mA, npn	Stainless steel V2A	2 m	INS-M08-B01NO-2C
				NO, 200 mA, npn			INS-M08-B01NS-2C
				NC, 200 mA, pnp			INS-M08-B01PO-2C
				NO, 200 mA, pnp			INS-M08-B01PS-2C
	M8 x 45	2	nf	NC, 200 mA, npn	Stainless steel V2A	2 m	INS-M08-N02NO-2C
				NO, 200 mA, npn			INS-M08-N02NS-2C
				NC, 200 mA, pnp			INS-M08-N02PO-2C
				NO, 200 mA, pnp			INS-M08-N02PS-2C
	M8 x 60	1	f	NC, 200 mA, npn	Stainless steel V2A	M8	INS-M08-B01NO-T3
				NO, 200 mA, npn			INS-M08-B01NS-T3
				NC, 200 mA, pnp			INS-M08-B01PO-T3
				NO, 200 mA, pnp			INS-M08-B01PS-T3
	M8 x 60	2	nf	NC, 200 mA, npn	Stainless steel V2A	M8	INS-M08-N02NO-T3
				NO, 200 mA, npn			INS-M08-N02NS-T3
NC, 200 mA, pnp				INS-M08-N02PO-T3			
NO, 200 mA, pnp				INS-M08-N02PS-T3			
M12 x 45	2	f	NC, 200 mA, npn	Brass nickel-plated	2 m	INS-M12-B02NO-2C	
			NO, 200 mA, npn			INS-M12-B02NS-2C	
			NC, 200 mA, pnp			INS-M12-B02PO-2C	
			NO, 200 mA, pnp			INS-M12-B02PS-2C	
M12 x 45	4	nf	NC, 200 mA, npn	Brass nickel-plated	M12	DCCK 12 M 04 NOK-IBSL	
			NO, 200 mA, npn			DCCK 12 M 04 NSK-IBSL	
			NC, 200 mA, pnp			DCCK 12 M 04 POK-IBSL	
			NO, 200 mA, pnp			DCCK 12 M 04 PSK-IBSL	
M12 x 45	4	nf	NC, 200 mA, npn	Brass nickel-plated	2 m	INS-M12-N04NO-2C	
			NO, 200 mA, npn			INS-M12-N04NS-2C	
			NC, 200 mA, pnp			INS-M12-N04PO-2C	
			NO, 200 mA, pnp			INS-M12-N04PS-2C	
M12 x 68	2	f	NC, 200 mA, npn	Brass nickel-plated	M12	INS-M12-B02NO-B3	
			NO, 200 mA, npn			INS-M12-B02NS-B3	
			NC, 200 mA, pnp			INS-M12-B02PO-B3	
			NO, 200 mA, pnp			INS-M12-B02PS-B3	

	Housing design Size (mm)	Switching distance (mm)	flush (f) / non-flush (nf) / quasi-flush (qf)	Switching output	Housing material	Cable length, plug connector	Product description	
<b>INS-100 Standard, Thread design</b>								
	M12 x 68	4	nf	NC, 200 mA, npn	Brass nickel-plated	M12	INS-M12-N04NO-B3	
				NO, 200 mA, npn			INS-M12-N04NS-B3	
				NC, 200 mA, pnp			INS-M12-N04PO-B3	
				NO, 200 mA, pnp			INS-M12-N04PS-B3	
	M18 x 55	5	f	NC, 200 mA, npn	Brass nickel-plated	2 m	INS-M18-B05NO-2C	
				NO, 200 mA, npn			INS-M18-B05NS-2C	
				NC, 200 mA, pnp			INS-M18-B05PO-2C	
				NO, 200 mA, pnp			INS-M18-B05PS-2C	
	M18 x 55	8	nf	NC, 200 mA, npn	Brass nickel-plated	2 m	INS-M18-N08NO-2C	
				NO, 200 mA, npn			INS-M18-N08NS-2C	
				NC, 200 mA, pnp			INS-M18-N08PO-2C	
				NO, 200 mA, pnp			INS-M18-N08PS-2C	
	M18 x 79	5	f	NC, 200 mA, npn	Brass nickel-plated	M12	INS-M18-B05NO-B3	
				NO, 200 mA, npn			INS-M18-B05NS-B3	
				NC, 200 mA, pnp			INS-M18-B05PO-B3	
				NO, 200 mA, pnp			INS-M18-B05PS-B3	
M18 x 79	8	nf	NC, 200 mA, npn	Brass nickel-plated	M12	INS-M18-N08NO-B3		
			NO, 200 mA, npn			INS-M18-N08NS-B3		
			NC, 200 mA, pnp			INS-M18-N08PO-B3		
			NO, 200 mA, pnp			INS-M18-N08PS-B3		
M30 x 55	10	f	NC, 200 mA, npn	Brass nickel-plated	2 m	INS-M30-B10NO-2C		
			NO, 200 mA, npn			INS-M30-B10NS-2C		
			NC, 200 mA, pnp			INS-M30-B10PO-2C		
			NO, 200 mA, pnp			INS-M30-B10PS-2C		
M30 x 55	15	nf	NC, 200 mA, npn	Brass nickel-plated	2 m	INS-M30-N15NO-2C		
			NO, 200 mA, npn			INS-M30-N15NS-2C		
			NC, 200 mA, pnp			INS-M30-N15PO-2C		
			NO, 200 mA, pnp			INS-M30-N15PS-2C		
M30 x 78	10	f	NC, 200 mA, npn	Brass nickel-plated	M12	INS-M30-B10NO-B3		
			NO, 200 mA, npn			INS-M30-B10NS-B3		
			NC, 200 mA, pnp			INS-M30-B10PO-B3		
			NO, 200 mA, pnp			INS-M30-B10PS-B3		
M30 x 78	15	nf	NC, 200 mA, npn	Brass nickel-plated	M12	INS-M30-N15NO-B3		
			NO, 200 mA, npn			INS-M30-N15NS-B3		
			NC, 200 mA, pnp			INS-M30-N15PO-B3		
			NO, 200 mA, pnp			INS-M30-N15PS-B3		
<b>INS-100 Standard, Cylinder design</b>								
	Ø 6.5x45	1	f	nnp, 200 mA, NC	Stainless steel V2A	2 m	INSM-6D5-B01NO-2C	
				nnp, 200 mA, NO			INSM-6D5-B01NS-2C	
				pnp, 200 mA, NC			INSM-6D5-B01PO-2C	
				pnp, 200 mA, NO			INSM-6D5-B01PS-2C	
	Ø 6.5x45	1	f	f	nnp, 200 mA, NC	Stainless steel V2A	M8	INSM-6D5-B01NO-T3
					nnp, 200 mA, NO			INSM-6D5-B01NS-T3
					pnp, 200 mA, NC			INSM-6D5-B01PO-T3
					pnp, 200 mA, NO			INSM-6D5-B01PS-T3

## INS-200 STANDARD 2-SN

The INS-200 Standard 2-Sn series scores in industrial applications with its twofold switching distance and its excellent price-performance ratio. These proximity sensors are equipped with a dual switching distance and are available in the standard lengths of Ø 6.5 mm to M30 and rectangular-shaped in 8 x 8 mm. Both devices are available with a high-quality PVC cable and sensors with a M8 or M12 plug connection as connection variants.



Technical data (typ.)		+20 °C, 24 VDC
Installation instructions	flush (f) / non-flush (nf) (see page 37)	
For more information, visit	www.di-soric.com	

	Housing design Size (mm)	Switching distance (mm)	flush (f) / non-flush (nf) / quasi-flush (qf)	Switching output	Housing material	Cable length, plug connector	Product description	
<b>INS-200 Standard 2-Sn, Thread design</b>								
	M8 x 45	2	f	npn, 200 mA, NC	Stainless steel V2A	2 m	INS-M08-B02NO-2C	
				npn, 200 mA, NO			INS-M08-B02NS-2C	
				npn, 200 mA, NC	Stainless steel	M12	DCC 08 M 02 NOK-IBSL	
				npn, 200 mA, NC			M8	DCC 08 M 02 NOK-TSL
				npn, 200 mA, NO			M12	DCC 08 M 02 NSK-IBSL
				npn, 200 mA, NO			M8	DCC 08 M 02 NSK-TSL
				pnp, 200 mA, NC	Stainless steel V2A	2 m	INS-M08-B02PO-2C	
				pnp, 200 mA, NO			INS-M08-B02PS-2C	
				pnp, 200 mA, NC	Stainless steel	M12	DCC 08 M 02 POK-IBSL	
				pnp, 200 mA, NC			M8	DCC 08 M 02 POK-TSL
				pnp, 200 mA, NO			M12	DCC 08 M 02 PSK-IBSL
				pnp, 200 mA, NO			M8	DCC 08 M 02 PSK-TSL
	M8 x 45	4	nf	npn, 200 mA, NC	Stainless steel V2A	2 m	INS-M08-N04NO-2C	
				npn, 200 mA, NO			INS-M08-N04NS-2C	
				pnp, 200 mA, NC			INS-M08-N04PO-2C	
				pnp, 200 mA, NO			INS-M08-N04PS-2C	
	M8 x 60	2	f	npn, 200 mA, NC	Stainless steel V2A	M8	INS-M08-B02NO-T3	
				npn, 200 mA, NO			INS-M08-B02NS-T3	
				pnp, 200 mA, NC			INS-M08-B02PO-T3	
				pnp, 200 mA, NO			INS-M08-B02PS-T3	
	M8 x 60	4	nf	npn, 200 mA, NC	Stainless steel V2A	M8	INS-M08-N04NO-T3	
				npn, 200 mA, NO			INS-M08-N04NS-T3	
				pnp, 200 mA, NC			INS-M08-N04PO-T3	
				pnp, 200 mA, NO			INS-M08-N04PS-T3	
M12 x 50	4	f	npn, 200 mA, NC	Nickel-plated brass	2m	INS-M12-B04NO-2C		
			npn, 200 mA, NO			INS-M12-B04NS-2C		
			pnp, 200 mA, NC			INS-M12-B04PO-2C		
			pnp, 200 mA, NO			INS-M12-B04PS-2C		
M12 x 50	8	nf	npn, 200 mA, NC	Nickel-plated brass	2m	INS-M12-N08NO-2C		
			npn, 200 mA, NO			INS-M12-N08NS-2C		
			pnp, 200 mA, NC			INS-M12-N08PO-2C		
			pnp, 200 mA, NO			INS-M12-N08PS-2C		

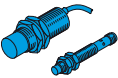
	Housing design Size (mm)	Switching distance (mm)	flush (f) / non-flush (nf) / quasi-flush (qf)	Switching output	Housing material	Cable length, plug connector	Product description
<b>INS-200 Standard 2-Sn, Thread design</b>							
	M12 x 68	4	f	npn, 200 mA, NC	Nickel-plated brass	M12	INS-M12-B04NO-B3
				npn, 200 mA, NO			INS-M12-B04NS-B3
				pnp, 200 mA, NC			INS-M12-B04PO-B3
				pnp, 200 mA, NO			INS-M12-B04PS-B3
	M12 x 68	8	nf	npn, 200 mA, NC	Nickel-plated brass	M12	INS-M12-N08NO-B3
				npn, 200 mA, NO			INS-M12-N08NS-B3
				pnp, 200 mA, NC			INS-M12-N08PO-B3
				pnp, 200 mA, NO			INS-M12-N08PS-B3
	M18 x 55	8	f	npn, 200 mA, NC	Nickel-plated brass	2m	INS-M18-B08NO-2C
				npn, 200 mA, NO			INS-M18-B08NS-2C
				pnp, 200 mA, NC			INS-M18-B08PO-2C
				pnp, 200 mA, NO			INS-M18-B08PS-2C
	M18 x 55	16	nf	npn, 200 mA, NC	Nickel-plated brass	2m	INS-M18-N16NO-2C
				npn, 200 mA, NO			INS-M18-N16NS-2C
				pnp, 200 mA, NC			INS-M18-N16PO-2C
				pnp, 200 mA, NO			INS-M18-N16PS-2C
M18 x 79	8	f	npn, 200 mA, NC	Nickel-plated brass	M12	INS-M18-B08NO-B3	
			npn, 200 mA, NO			INS-M18-B08NS-B3	
			pnp, 200 mA, NC			INS-M18-B08PO-B3	
			pnp, 200 mA, NO			INS-M18-B08PS-B3	
M18 x 79	16	nf	npn, 200 mA, NC	Nickel-plated brass	M12	INS-M18-N16NO-B3	
			npn, 200 mA, NO			INS-M18-N16NS-B3	
			pnp, 200 mA, NC			INS-M18-N16PO-B3	
			pnp, 200 mA, NO			INS-M18-N16PS-B3	
M30 x 55	15	f	npn, 200 mA, NC	Nickel-plated brass	2m	INS-M30-B15NO-2C	
			npn, 200 mA, NO			INS-M30-B15NS-2C	
			pnp, 200 mA, NC			INS-M30-B15PO-2C	
			pnp, 200 mA, NO			INS-M30-B15PS-2C	
M30 x 55	15	f	npn, 200 mA, NC	Nickel-plated brass	M12	INS-M30-B15NO-B3	
			npn, 200 mA, NO			INS-M30-B15NS-B3	
M30 x 55	25	nf	npn, 200 mA, NC	Nickel-plated brass	2m	INS-M30-N25NO-2C	
			npn, 200 mA, NO			INS-M30-N25NS-2C	
			pnp, 200 mA, NC			INS-M30-N25PO-2C	
			pnp, 200 mA, NO			INS-M30-N25PS-2C	
M30 x 78	15	f	pnp, 200 mA, NC	Nickel-plated brass	M12	INS-M30-B15PO-B3	
			pnp, 200 mA, NO			INS-M30-B15PS-B3	
M30 x 78	25	nf	npn, 200 mA, NC	Nickel-plated brass	M12	INS-M30-N25NO-B3	
			npn, 200 mA, NO			INS-M30-N25NS-B3	
			pnp, 200 mA, NC			INS-M30-N25PO-B3	
			pnp, 200 mA, NO			INS-M30-N25PS-B3	

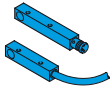
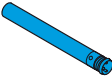
	Housing design Size (mm)	Switching distance (mm)	flush (f) / non-flush (nf) / quasi-flush (qf)	Switching output	Housing material	Cable length, plug connector	Product description
<b>INS-200 Standard 2-Sn, Rectangular design</b>							
	8 x 8 x 40	2	f	npn, 200 mA, NC	Nickel-plated brass	2 m	INS-Q08-B02NO-2C
				npn, 200 mA, NO			INS-Q08-B02NS-2C
				pnp, 200 mA, NC			INS-Q08-B02PO-2C
				pnp, 200 mA, NO			INS-Q08-B02PS-2C
	8 x 8 x 40	2	f	npn, 200 mA, NC	Nickel-plated brass	M8	INS-Q08-B02NO-T3
				npn, 200 mA, NO			INS-Q08-B02NS-T3
				pnp, 200 mA, NC			INS-Q08-B02PO-T3
				pnp, 200 mA, NO			INS-Q08-B02PS-T3
<b>INS-200 Standard 2-Sn, Cylinder design</b>							
	Ø6.5 x 45	2	f	npn, 200 mA, NC	Stainless steel V2A	2 m	INSM-6D5-B02NO-2C
				npn, 200 mA, NO			INSM-6D5-B02NS-2C
				pnp, 200 mA, NC			INSM-6D5-B02PO-2C
				pnp, 200 mA, NO			INSM-6D5-B02PS-2C
	Ø6.5 x 45	2	f	npn, 200 mA, NC	Stainless steel	M8	DCC 6.5 V 02 NOK-TSL
				npn, 200 mA, NO			DCC 6.5 V 02 NSK-TSL
				pnp, 200 mA, NC			DCC 6.5 V 02 POK-TSL
				pnp, 200 mA, NO			DCC 6.5 V 02 PSK-TSL
	Ø6.5 x 60	2	f	npn, 200 mA, NC	Stainless steel V2A	M8	INSM-6D5-B02NO-T3
				npn, 200 mA, NO			INSM-6D5-B02NS-T3
				pnp, 200 mA, NC			INSM-6D5-B02PO-T3
				pnp, 200 mA, NO			INSM-6D5-B02PS-T3

## INM-100 MINIATURE

A large selection of efficient miniature sensors, especially for the smallest and narrowest of space, is offered by our INM-100 Miniature series. The sensors are available from Ø 3.0 mm to M5, as well as in rectangular form with 5 x 5 mm. These very compact designs distinguish themselves with a stable metal casing and highly flexible cable variants in PVC and PUR.

Technical data (typ.)		+20 °C, 24 VDC
Installation instructions	flush (f) / non-flush (nf) (see page 37)	
For more information, visit	www.di-soric.com	

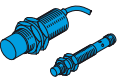

	Housing design Size (mm)	Switching distance (mm)	flush (f) / non-flush (nf) / quasi-flush (qf)	Switching output	Housing material	Cable length, plug connector	Product description
<b>INM-100 Miniature, Thread design</b>							
	M4 x 22	0.6	f	npn, 100 mA, NC	Stainless steel V2A	2 m	DCC 04 M 0.6 NOLK
				nnp, 100 mA, NO			DCC 04 M 0.6 NSLK
				pnp, 100 mA, NC			DCC 04 M 0.6 POLK
				pnp, 100 mA, NO			DCC 04 M 0.6 PSLK
	M4 x 22	0.6	f	npn, 100 mA, NC	Stainless steel V2A	M8	DCC 04 M 0.6 NOK-K-TSL
				nnp, 100 mA, NO			DCC 04 M 0.6 NSK-K-TSL
				pnp, 100 mA, NC			DCC 04 M 0.6 POK-K-TSL
				pnp, 100 mA, NO			DCC 04 M 0.6 PSK-K-TSL
	M4 x 26	0.8	f	npn, 200 mA, NC	Stainless steel V2A	2 m	INSM-M04-B0.8NO-2C
				nnp, 200 mA, NO			INSM-M04-B0.8NS-2C
				pnp, 200 mA, NC			INSM-M04-B0.8PO-2C
				pnp, 200 mA, NO			INSM-M04-B0.8PS-2C
M5 x 24.9	0.8	f	pnp, 100 mA, NC	Stainless steel AISI303	M8	DCC 05 V 0.8 POK-K-TSL	
			pnp, 100 mA, NO			DCC 05 V 0.8 PSK-K-TSL	
			pnp, 100 mA, NO			DCC 05 V 0.8 PSK-K-TSL	
M5 x 28	0.8	f	npn, 200 mA, NC	Stainless steel V2A	2 m	INSM-M05-B0.8NO-2C	
			nnp, 200 mA, NO			INSM-M05-B0.8NS-2C	
			pnp, 200 mA, NC			INSM-M05-B0.8PO-2C	
			pnp, 200 mA, NO			INSM-M05-B0.8PS-2C	
M5 x 40	0.8	f	npn, 200 mA, NC	Stainless steel V2A	M8	INSM-M05-B0.8NO-T3	
			nnp, 200 mA, NO			INSM-M05-B0.8NS-T3	
			pnp, 200 mA, NC			INSM-M05-B0.8PO-T3	
			pnp, 200 mA, NO			INSM-M05-B0.8PS-T3	

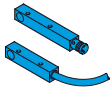
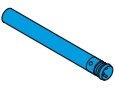

	Housing design Size (mm)	Switching distance (mm)	flush (f) / non-flush (nf) / quasi-flush (qf)	Switching output	Housing material	Cable length, plug connector	Product description
<b>INM-100 Miniature, Rectangular design</b>							
	5 x 5 x 25	0.8	f	npn, 200 mA, NC	Nickel-plated brass	2 m	DCCQ 05 M 0.8 NOLK
	5 x 5 x 25	0.8	f	npn, 200 mA, NO	Nickel-plated brass	M8	DCCQ 05 M 0.8 NSK-K-TSL
				nnp, 200 mA, NC			DCCQ 05 M 0.8 NOK-K-TSL
				pnp, 200 mA, NC			DCCQ 05 M 0.8 POK-K-TSL
				pnp, 200 mA, NO			DCCQ 05 M 0.8 PSK-K-TSL
	5 x 5 x 27	0.8	f	nnp, 200 mA, NC	Nickel-plated brass	2 m	INSM-Q05-B0.8NO-2C
				nnp, 200 mA, NO			INSM-Q05-B0.8NS-2C
				pnp, 200 mA, NC			INSM-Q05-B0.8PO-2C
				pnp, 200 mA, NO			INSM-Q05-B0.8PS-2C
<b>INM-100 Miniature, Cylinder design</b>							
	Ø3 x 22	0.6	f	nnp, 100 mA, NC	Stainless steel V2A	2 m	DCC 3.0 V 0.6 NOLK
				nnp, 100 mA, NO			DCC 3.0 V 0.6 NSLK
				pnp, 100 mA, NC			DCC 3.0 V 0.6 POLK
				pnp, 100 mA, NO			DCC 3.0 V 0.6 PSLK
	Ø3 x 22	0.6	f	nnp, 100 mA, NC	Stainless steel V2A	0.15 m, M8	DCC 3.0 V 0.6 NOK-K-TSL
				nnp, 100 mA, NO			DCC 3.0 V 0.6 NSK-K-TSL
				pnp, 100 mA, NC			DCC 3.0 V 0.6 POK-K-TSL
				pnp, 100 mA, NO			DCC 3.0 V 0.6 PSK-K-TSL
	Ø3 x 26	0.6	f	nnp, 200 mA, NC	Stainless steel V2A	2 m	INSM-D03-B0.6NO-2C
				nnp, 200 mA, NO			INSM-D03-B0.6NS-2C
				pnp, 200 mA, NC			INSM-D03-B0.6PO-2C
				pnp, 200 mA, NO			INSM-D03-B0.6PS-2C
	Ø4 x 24.9	0.8	f	nnp, 100 mA, NO	Stainless steel AISI303	0.3 m, M8	DCC 4.0 V 0.8 NSK-K-TSL
				pnp, 100 mA, NC			DCC 4.0 V 0.8 POK-K-TSL
				pnp, 100 mA, NO			DCC 4.0 V 0.8 PSK-K-TSL
				pnp, 100 mA, NO			DCC 4.0 V 0.8 PSK-K-TSL
	Ø4 x 26	0.8	f	nnp, 200 mA, NC	Stainless steel V2A	2 m	INSM-D04-B0.8NO-2C
				nnp, 200 mA, NO			INSM-D04-B0.8NS-2C
pnp, 200 mA, NC				INSM-D04-B0.8PO-2C			
pnp, 200 mA, NO				INSM-D04-B0.8PS-2C			
Ø4 x 40	0.8	f	nnp, 200 mA, NC	Stainless steel V2A	M8	INSM-D04-B0.8NO-T3	
			nnp, 200 mA, NO			INSM-D04-B0.8NS-T3	
			pnp, 200 mA, NC			INSM-D04-B0.8PO-T3	
			pnp, 200 mA, NO			INSM-D04-B0.8PS-T3	

## INM-300 MINIATURE EXTENDED

Ambitious miniature sensors with enormous power reserve and especially for the smallest and narrowest of spaces, can be found in our INM-300 Miniature Extended series. The sensors are available from Ø 3.0 mm to M5, as well as in rectangular form with 5 x 5 mm. Highly precise detection in applications with extended switching distance and a compact design, stable metal casing, as well as highly flexible PVC and PUR connection cables distinguish our INM-300 Miniature Extended series.



Technical data (typ.)		+20 °C, 24 VDC
Installation instructions	flush (f) / non-flush (nf) (see page 37)	
For more information, visit	www.di-soric.com	

	Housing design Size (mm)	Switching distance (mm)	flush (f) / non-flush (nf) / quasi-flush (qf)	Switching output	Housing material	Cable length, plug connector	Product description
<b>INM-300 Miniature Extended, Thread design</b>							
	M4 x 22	1	f	npn, 100 mA, NC npn, 100 mA, NO pnp, 100 mA, NC pnp, 100 mA, NO	Stainless steel V2A	2 m	DCC 04 V 1.0 NOLK DCC 04 V 1.0 NSLK DCC 04 V 1.0 POLK DCC 04 V 1.0 PSLK
	M4 x 22	1	f	npn, 100 mA, NC npn, 100 mA, NO pnp, 100 mA, NC pnp, 100 mA, NO	Stainless steel V2A	0.15 m, M8	DCC 04 V 1.0 NOK-K-TSL DCC 04 V 1.0 NSK-K-TSL DCC 04 V 1.0 POK-K-TSL DCC 04 V 1.0 PSK-K-TSL
	M5 x 24.9	1.5	f	npn, 100 mA, NC npn, 100 mA, NO pnp, 100 mA, NC pnp, 100 mA, NO	Stainless steel AISI303	2 m	DCC 05 V 1.5 NOLK DCC 05 V 1.5 NSLK DCC 05 V 1.5 POLK DCC 05 V 1.5 PSLK DCC 05 V 1.5 PSLK/5m
	M5 x 24.9	1.5	f	npn, 100 mA, NC pnp, 100 mA, NO pnp, 100 mA, NC pnp, 100 mA, NO	Stainless steel AISI303	0.3 m, M8 0.6 m, M8 0.3 m, M8 0.3 m, M8	DCC 05 V 1.5 NOK-K-TSL DCC 05 V 1.5 PSK-K0.6-TSL DCC 05 V 1.5 POK-K-TSL DCC 05 V 1.5 PSK-K-TSL
	M5 x 25	2.5	f	npn, 200 mA, NO pnp, 200 mA, NC pnp, 200 mA, NO	Chrome-plated nickel-silver	2 m	DCC 05 V 2.5 NSLK DCC 05 V 2.5 POLK DCC 05 V 2.5 PSLK
	M5 x 28	1	f	npn, 200 mA, NC npn, 200 mA, NO pnp, 200 mA, NC pnp, 200 mA, NO	Stainless steel V2A	2 m	INSM-M05-B01N0-2C INSM-M05-B01NS-2C INSM-M05-B01P0-2C INSM-M05-B01PS-2C
	M5 x 38	2.5	f	npn, 200 mA, NC npn, 200 mA, NO pnp, 200 mA, NC pnp, 200 mA, NO	Chrome-plated nickel-silver	M8	DCC 05 V 2.5 NOK-TSL DCC 05 V 2.5 NSK-TSL DCC 05 V 2.5 POK-TSL DCC 05 V 2.5 PSK-TSL
	M5 x 38.4	1.5	f	npn, 100 mA, NC npn, 100 mA, NO pnp, 100 mA, NC pnp, 100 mA, NO	Stainless steel AISI303	M8	DCC 05 V 1.5 NOK-TSL DCC 05 V 1.5 NSK-TSL DCC 05 V 1.5 POK-TSL DCC 05 V 1.5 PSK-TSL

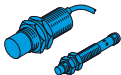
	Housing design Size (mm)	Switching distance (mm)	flush (f) / non-flush (nf) / quasi-flush (qf)	Switching output	Housing material	Cable length, plug connector	Product description	
<b>INM-300 Miniature Extended, Thread design</b>								
	M5 x 40	1	f	npn, 200 mA, NC	Stainless steel V2A	M8	INSM-M05-B01NO-T3	
				npn, 200 mA, NO			INSM-M05-B01NS-T3	
				pnp, 200 mA, NC			INSM-M05-B01PO-T3	
				pnp, 200 mA, NO			INSM-M05-B01PS-T3	
<b>INM-300 Miniature Extended, Rectangular design</b>								
	5 x 5 x 25	1.5	f	npn, 200 mA, NC	Chrome-plated nickel-brass	2 m	DCCQ 05 M 1.5 NOLK	
				npn, 200 mA, NO			DCCQ 05 M 1.5 NSLK	
				pnp, 200 mA, NC			DCCQ 05 M 1.5 POLK	
				pnp, 200 mA, NO			DCCQ 05 M 1.5 PSLK	
	5 x 5 x 25	1.5	f	f	npn, 200 mA, NC	Chrome-plated nickel-brass	0.2 m, M8	DCCQ 05 M 1.5 NOK-K-TSL
					npn, 200 mA, NO			DCCQ 05 M 1.5 NSK-K-TSL
					pnp, 200 mA, NC			DCCQ 05 M 1.5 POK-K-TSL
					pnp, 200 mA, NO			DCCQ 05 M 1.5 PSK-K-TSL
	5 x 5 x 27	1	f	f	npn, 200 mA, NC	Nickel-plated brass	2 m	INSM-Q05-B01NO-2C
					npn, 200 mA, NO			INSM-Q05-B01NS-2C
					pnp, 200 mA, NC			INSM-Q05-B01PO-2C
					pnp, 200 mA, NO			INSM-Q05-B01PS-2C
<b>INM-300 Miniature Extended, Cylinder design</b>								
	Ø3 x 22	1	f	npn, 100 mA, NC	Stainless steel V2A	2 m	DCC 3.0 V 1.0 NOLK	
				npn, 100 mA, NO			DCC 3.0 V 1.0 NSLK	
				pnp, 100 mA, NC			DCC 3.0 V 1.0 POLK	
				pnp, 100 mA, NO			DCC 3.0 V 1.0 PSLK	
	Ø3 x 22	1	f	f	npn, 100 mA, NC	Stainless steel V2A	0.15 m, M8	DCC 3.0 V 1.0 NOK-K-TSL
					npn, 100 mA, NO			DCC 3.0 V 1.0 NSK-K-TSL
					pnp, 100 mA, NC			DCC 3.0 V 1.0 POK-K-TSL
					pnp, 100 mA, NO			DCC 3.0 V 1.0 PSK-K-TSL
	Ø4 x 24.9	1.5	f	f	npn, 100 mA, NC	Stainless steel AISI303	2 m	DCC 4.0 V 1.5 NOLK
					npn, 100 mA, NO			DCC 4.0 V 1.5 NSLK
					pnp, 100 mA, NC			DCC 4.0 V 1.5 POLK
					pnp, 100 mA, NO			DCC 4.0 V 1.5 PSLK
	Ø4 x 24.9	1.5	f	f	npn, 100 mA, NO	Stainless steel AISI303	0.3 m, M8	DCC 4.0 V 1.5 NSK-K-TSL
					pnp, 100 mA, NO		0.6 m, M8	DCC 4.0 V 1.5 PSK-K0.6-TSL
pnp, 100 mA, NC					0.3 m, M8		DCC 4.0 V 1.5 POK-K-TSL	
pnp, 100 mA, NO					0.3 m, M8		DCC 4.0 V 1.5 PSK-K-TSL	
Ø4 x 25	2.5	f	f	npn, 200 mA, NC	Nickel-silver	2 m	DCC 4.0 V 2.5 NOLK	
				npn, 200 mA, NO			DCC 4.0 V 2.5 NSLK	
				pnp, 200 mA, NC			DCC 4.0 V 2.5 POLK	
				pnp, 200 mA, NO			DCC 4.0 V 2.5 PSLK	
Ø4 x 25	2.5	f	f	npn, 200 mA, NO	Nickel-silver	M8	DCC 4.0 V 2.5 NSK-TSL	
				npn, 200 mA, NC			DCC 4.0 V 2.5 NOK-TSL	
				pnp, 200 mA, NC			DCC 4.0 V 2.5 POK-TSL	
				pnp, 200 mA, NO			DCC 4.0 V 2.5 PSK-TSL	
Ø4 x 38.4	1.5	f	f	npn, 100 mA, NC	Stainless steel AISI303	M8	DCC 4.0 V 1.5 NOK-TSL	
				pnp, 100 mA, NC			DCC 4.0 V 1.5 POK-TSL	
				pnp, 100 mA, NO			DCC 4.0 V 1.5 PSK-TSL	
				pnp, 100 mA, NO			DCC 4.0 V 1.5 PSK-TSL	

## INE EXTENDED

The sensors in the INE Extended series are robust sensors in all sizes up to M30, which offer more than just the standard. Thanks to their double and triple switching distances, they exhibit greater mounting tolerances. The INE sensors are available in normal and short designs. In addition to the common standard connections with plugs or PVC cables, PUR cables and cables with connector are also available.



Technical data (typ.)	+20 °C, 24 VDC
Installation instructions	flush (f) / non-flush (nf) (see page 37)
For more information, visit	www.di-soric.com

	Housing design Size (mm)	Switching distance (mm)	flush (f) / non-flush (nf) / quasi-flush (qf)	Switching output	Housing material	Cable length, plug connector	Product description
<b>INE Extended, Thread design</b>							
	M12 x 35	4	f	npn, 200 mA, NC npn, 200 mA, NO pnp, 200 mA, NC pnp, 200 mA, NO	Nickel-plated brass	2m	DCCK 12 M 04 B NOLK DCCK 12 M 04 B NSLK DCCK 12 M 04 B POLK DCCK 12 M 04 B PSLK
	M12 x 35	4	nf	npn, 200 mA, NC npn, 200 mA, NO pnp, 200 mA, NC pnp, 200 mA, NO	Nickel-plated brass	2m	DCCK 12 M 04 NOLK DCCK 12 M 04 NSLK DCCK 12 M 04 POLK DCCK 12 M 04 PSLK
	M12 x 35	6	qf	npn, 200 mA, NC npn, 200 mA, NO pnp, 200 mA, NC pnp, 200 mA, NO	Chrome-plated brass	2m	DCCK 12 M 06 NOLK DCCK 12 M 06 NSLK DCCK 12 M 06 POLK DCCK 12 M 06 PSLK
	M12 x 35	10	nf	npn, 200 mA, NC npn, 200 mA, NO pnp, 200 mA, NC pnp, 200 mA, NO	Chrome-plated brass	2m	DCCK 12 M 10 NOLK DCCK 12 M 10 NSLK DCCK 12 M 10 POLK DCCK 12 M 10 PSLK
	M12 x 39.8	4	f	npn, 200 mA, NO pnp, 200 mA, NO	Nickel-plated brass	2m	DCBK 12 MB 04 NS-3 DCBK 12 MB 04 PS-3
	M12 x 39.8	8	nf	npn, 200 mA, NO pnp, 200 mA, NO	Nickel-plated brass	2m	DCBK 12 MN 08 NS-3 DCBK 12 MN 08 PS-3
	M12 x 45	4	f	npn, 200 mA, NO pnp, 200 mA, NC pnp, 200 mA, NO	Nickel-plated brass	M12	DCCK 12 M 04 B NSK-IBSL DCCK 12 M 04 B POK-IBSL DCCK 12 M 04 B PSK-IBSL
	M12 x 45	6	qf	npn, 200 mA, NC npn, 200 mA, NO pnp, 200 mA, NC pnp, 200 mA, NO	Chrome-plated brass	M12	DCCK 12 M 06 NOK-IBSL DCCK 12 M 06 NSK-IBSL DCCK 12 M 06 POK-IBSL DCCK 12 M 06 PSK-IBSL
	M12 x 45	10	nf	npn, 200 mA, NC npn, 200 mA, NO pnp, 200 mA, NC pnp, 200 mA, NO	Chrome-plated brass	M12	DCCK 12 M 10 NOK-IBSL DCCK 12 M 10 NSK-IBSL DCCK 12 M 10 POK-IBSL DCCK 12 M 10 PSK-IBSL
	M12 x 49.8	4	f	npn, 200 mA, NO pnp, 200 mA, NO	Nickel-plated brass	2m	DCB 12 MB 04 NS-3 DCB 12 MB 04 PS-3
	M12 x 49.8	8	nf	npn, 200 mA, NO pnp, 200 mA, NO	Nickel-plated brass	2m	DCB 12 MN 08 NS-3 DCB 12 MN 08 PS-3

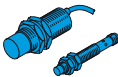





Housing design Size (mm)	Switching distance (mm)	flush (f) / non-flush (nf) / Quasi-flush (qf)	Switching output	Housing material	Cable length, plug connector	Product description
<b>INE Extended, Thread design</b>						
	M12 x 50	4	f	npn, 200 mA, NO pnp, 200 mA, NC pnp, 200 mA, NO	Chrome-plated brass	2m DCC 12 M 04 B NSLK DCC 12 M 04 B POLK DCC 12 M 04 B PSLK
	M12 x 50	6	qf	npn, 200 mA, NC npn, 200 mA, NO pnp, 200 mA, NC pnp, 200 mA, NO	Chrome-plated brass	2m DCC 12 M 06 NOLK DCC 12 M 06 NSLK DCC 12 M 06 POLK DCC 12 M 06 PSLK
	M12 x 50	10	nf	npn, 200 mA, NC npn, 200 mA, NO pnp, 200 mA, NC pnp, 200 mA, NO	Chrome-plated brass	2m DCC 12 M 10 NOLK DCC 12 M 10 NSLK DCC 12 M 10 POLK DCC 12 M 10 PSLK
	M12 x 52.3	4	f	npn, 200 mA, NO pnp, 200 mA, NC pnp, 200 mA, NO	Nickel-plated brass	M12 DCBK 12 MB 04 NS-B3 DCBK 12 MB 04 PO-B3 DCBK 12 MB 04 PS-B3
	M12 x 52.3	8	nf	npn, 200 mA, NO pnp, 200 mA, NO	Nickel-plated brass	M12 DCBK 12 MN 08 NS-B3 DCBK 12 MN 08 PS-B3
	M12 x 60	4	f	npn, 200 mA, NC npn, 200 mA, NO pnp, 200 mA, NC pnp, 200 mA, NO	Nickel-plated brass	M12 DCC 12 M 04 B NOK-IBSL DCC 12 M 04 B NSK-IBSL DCC 12 M 04 B POK-IBSL DCC 12 M 04 B PSK-IBSL
	M12 x 60	6	qf	npn, 200 mA, NC npn, 200 mA, NO pnp, 200 mA, NC pnp, 200 mA, NO	Chrome-plated brass	M12 DCC 12 M 06 NOK-IBSL DCC 12 M 06 NSK-IBSL DCC 12 M 06 POK-IBSL DCC 12 M 06 PSK-IBSL
	M12 x 60	10	nf	npn, 200 mA, NC npn, 200 mA, NO pnp, 200 mA, NC pnp, 200 mA, NO	Chrome-plated brass	M12 DCC 12 M 10 NOK-IBSL DCC 12 M 10 NSK-IBSL DCC 12 M 10 POK-IBSL DCC 12 M 10 PSK-IBSL
	M12 x 64.8	4	f	npn, 200 mA, NO pnp, 200 mA, NO	Nickel-plated brass	M12 DCB 12 MB 04 NS-B3 DCB 12 MB 04 PS-B3
	M12 x 64.8	8	nf	npn, 200 mA, NO pnp, 200 mA, NO	Nickel-plated brass	M12 DCB 12 MN 08 NS-B3 DCB 12 MN 08 PS-B3
	M18 x 35	8	qf	npn, 200 mA, NC npn, 200 mA, NO pnp, 200 mA, NO	Nickel-plated brass	2m DCCK 18 M 08 B NOLK DCCK 18 M 08 B NSLK DCCK 18 M 08 B PSLK
	M18 x 36	12	qf	npn, 200 mA, NC npn, 200 mA, NO pnp, 200 mA, NC pnp, 200 mA, NO	Chrome-plated brass	2m DCCK 18 M 12 NOLK DCCK 18 M 12 NSLK DCCK 18 M 12 POLK DCCK 18 M 12 PSLK
	M18 x 36	20	nf	npn, 200 mA, NC npn, 200 mA, NO pnp, 200 mA, NC pnp, 200 mA, NO	Chrome-plated brass	2m DCCK 18 M 20 NOLK DCCK 18 M 20 NSLK DCCK 18 M 20 POLK DCCK 18 M 20 PSLK
	M18 x 48.5	12	qf	npn, 200 mA, NC npn, 200 mA, NO pnp, 200 mA, NC pnp, 200 mA, NO	Chrome-plated brass	M12 DCCK 18 M 12 NOK-IBSL DCCK 18 M 12 NSK-IBSL DCCK 18 M 12 POK-IBSL DCCK 18 M 12 PSK-IBSL

Housing design Size (mm)	Switching distance (mm)	flush (f) / non-flush (nf) / quasi-flush (qf)	Switching output	Housing material	Cable length, plug connector	Product description	
<b>INE Extended, Thread design</b>							
	M18 x 48.5	20	nf	npn, 200 mA, NC	Chrome-plated brass	M12	DCCK 18 M 20 NOK-IBSL
				npn, 200 mA, NO			DCCK 18 M 20 NSK-IBSL
				pnp, 200 mA, NC			DCCK 18 M 20 POK-IBSL
				pnp, 200 mA, NO			DCCK 18 M 20 PSK-IBSL
	M18 x 50	8	f	npn, 400 mA, NO	Nickel-plated brass	2m	DCB 18 MB 08 NS-3
				pnp, 400 mA, NO			DCB 18 MB 08 PS-3
				pnp, 200 mA, NC			DCC 18 M 08 B POLK
	M18 x 50	8	qf	npn, 200 mA, NO	Nickel-plated brass	2m	DCC 18 M 08 B NSLK
				pnp, 200 mA, NO			DCC 18 M 08 B PSLK
	M18 x 50	8	qf	npn, 200 mA, NO	Nickel-plated brass	M12	DCCK 18 M 08 B NSK-IBSL
				pnp, 200 mA, NO			DCCK 18 M 08 B PSK-IBSL
	M18 x 50	12	nf	npn, 400 mA, NO	Nickel-plated brass	2m	DCB 18 MN 12 NS-3
				pnp, 400 mA, NO			DCB 18 MN 12 PS-3
	M18 x 51	12	qf	npn, 200 mA, NC	Chrome-plated brass	2m	DCC 18 M 12 NOLK
				npn, 200 mA, NO			DCC 18 M 12 NSLK
				pnp, 200 mA, NC			DCC 18 M 12 POLK
pnp, 200 mA, NO				DCC 18 M 12 PSLK			
M18 x 51	20	nf	npn, 200 mA, NC	Chrome-plated brass	2m	DCC 18 M 20 NOLK	
			npn, 200 mA, NO			DCC 18 M 20 NSLK	
			pnp, 200 mA, NC			DCC 18 M 20 POLK	
			pnp, 200 mA, NO			DCC 18 M 20 PSLK	
M18 x 51	20	nf	pnp, 200 mA, NO	Chrome-plated brass	0.2 m, M12	DCC 18 M 20 PSK-K-IBS	
M18 x 63.5	12	qf	npn, 200 mA, NC	Chrome-plated brass	M12	DCC 18 M 12 NOK-IBSL	
			npn, 200 mA, NO			DCC 18 M 12 NSK-IBSL	
			pnp, 200 mA, NC			DCC 18 M 12 POK-IBSL	
			pnp, 200 mA, NO			DCC 18 M 12 PSK-IBSL	
M18 x 63.5	20	nf	npn, 200 mA, NC	Chrome-plated brass	M12	DCC 18 M 20 NOK-IBSL	
			npn, 200 mA, NO			DCC 18 M 20 NSK-IBSL	
			pnp, 200 mA, NC			DCC 18 M 20 POK-IBSL	
			pnp, 200 mA, NO			DCC 18 M 20 PSK-IBSL	
M18 x 64	8	f	npn, 400 mA, NO	Nickel-plated brass	M12	DCB 18 MB 08 NS-B3	
			pnp, 400 mA, NO			DCB 18 MB 08 PS-B3	
M18 x 64	12	nf	npn, 400 mA, NO	Nickel-plated brass	M12	DCB 18 MN 12 NS-B3	
			pnp, 400 mA, NO			DCB 18 MN 12 PS-B3	
M18 x 65	8	qf	npn, 200 mA, NO	Nickel-plated brass	M12	DCC 18 M 08 B NSK-IBSL	
			pnp, 200 mA, NC			DCC 18 M 08 B POK-IBSL	
			pnp, 200 mA, NO			DCC 18 M 08 B PSK-IBSL	
M30 x 35	22	qf	npn, 200 mA, NC	Chrome-plated brass	2m	DCCK 30 M 22 NOLK	
			npn, 200 mA, NO			DCCK 30 M 22 NSLK	
			pnp, 200 mA, NO			DCCK 30 M 22 PSLK	
M30 x 35	40	nf	npn, 200 mA, NC	Chrome-plated brass	2m	DCCK 30 M 40 NOLK	
			npn, 200 mA, NO			DCCK 30 M 40 NSLK	
			pnp, 200 mA, NC			DCCK 30 M 40 POLK	
			pnp, 200 mA, NO			DCCK 30 M 40 PSLK	
M30 x 48.5	22	qf	npn, 200 mA, NC	Chrome-plated brass	M12	DCCK 30 M 22 NOK-IBSL	
			npn, 200 mA, NO			DCCK 30 M 22 NSK-IBSL	
			pnp, 200 mA, NC			DCCK 30 M 22 POK-IBSL	
			pnp, 200 mA, NO			DCCK 30 M 22 PSK-IBSL	

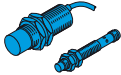
	Housing design Size (mm)	Switching distance (mm)	flush (f) / non-flush (nf) / quasi-flush (qf)	Switching output	Housing material	Cable length, plug connector	Product description
	M30 x 48.5	30	nf	pnp, 200 mA, NO	Chrome-plated brass	M12	DCC 30 M 30 PSK-IBSL
	M30 x 48.5	40	nf	npn, 200 mA, NC	Chrome-plated brass	M12	DCCK 30 M 40 NOK-IBSL
				npn, 200 mA, NO			DCCK 30 M 40 NSK-IBSL
				pnnp, 200 mA, NC			DCCK 30 M 40 POK-IBSL
				pnnp, 200 mA, NO			DCCK 30 M 40 PSK-IBSL
	M30 x 60	15	f	npn, 400 mA, NO	Nickel-plated brass	2m	DCB 30 MB 15 NS-3
				pnnp, 400 mA, NO			DCB 30 MB 15 PS-3
	M30 x 60	20	nf	npn, 400 mA, NC	Nickel-plated brass	2m	DCB 30 MN 20 NO-3
				npn, 400 mA, NO			DCB 30 MN 20 NS-3
				pnnp, 400 mA, NO			DCB 30 MN 20 PS-3
	M30 x 60	22	qf	npn, 200 mA, NC	Chrome-plated brass	2m	DCC 30 M 22 NOLK
				npn, 200 mA, NO			DCC 30 M 22 NSLK
				pnnp, 200 mA, NC			DCC 30 M 22 POLK
				pnnp, 200 mA, NC			DCCK 30 M 22 POLK
				pnnp, 200 mA, NO			DCC 30 M 22 PSLK
	M30 x 73.5	22	qf	npn, 200 mA, NC	Chrome-plated brass	M12	DCC 30 M 22 NOK-IBSL
				npn, 200 mA, NO			DCC 30 M 22 NSK-IBSL
				pnnp, 200 mA, NC			DCC 30 M 22 POK-IBSL
pnnp, 200 mA, NO				DCC 30 M 22 PSK-IBSL			
M30 x 76	15	f	npn, 400 mA, NO	Nickel-plated brass	M12	DCB 30 MB 15 NS-B3	
			pnnp, 400 mA, NO			DCB 30 MB 15 PS-B3	
M30 x 76	20	nf	npn, 400 mA, NO	Nickel-plated brass	M12	DCB 30 MN 20 NS-B3	
			pnnp, 400 mA, NO			DCB 30 MN 20 PS-B3	
M8 x 16	2	f	npn, 200 mA, NC	Stainless steel	2m	DCC 08 M 02 NOLK/16	
			npn, 200 mA, NO			DCC 08 M 02 NSLK/16	
			pnnp, 200 mA, NC			DCC 08 M 02 POLK/16	
			pnnp, 200 mA, NO			DCC 08 M 02 PSLK/16	
M8 x 22	2	f	npn, 200 mA, NC	Stainless steel	2m	DCC 08 M 02 NOLK/22	
			npn, 200 mA, NO			DCC 08 M 02 NSLK/22	
			pnnp, 200 mA, NC			DCC 08 M 02 POLK/22	
			pnnp, 200 mA, NO			DCC 08 M 02 PSLK/22	
M8 x 30	2	f	npn, 200 mA, NC	Stainless steel	2m	DCC 08 M 02 NOLK/30	
			npn, 200 mA, NO			DCC 08 M 02 NSLK/30	
			pnnp, 200 mA, NC			DCC 08 M 02 POLK/30	
			pnnp, 200 mA, NO			DCC 08 M 02 PSLK/30	
M8 x 30	2	f	npn, 200 mA, NC	Stainless steel	M8	DCC 08 M 02 NOK-TSL/29	
			npn, 200 mA, NO			DCC 08 M 02 NSK-TSL/29	
			pnnp, 200 mA, NC			DCC 08 M 02 POK-TSL/29	
			pnnp, 200 mA, NO			DCC 08 M 02 PSK-TSL/29	
M8 x 32	2	f	npn, 200 mA, NC	Stainless steel	M8	DCC 08 M 02 NOK-TSL/32	
			npn, 200 mA, NO			DCC 08 M 02 NSK-TSL/32	
			pnnp, 200 mA, NC			DCC 08 M 02 POK-TSL/32	
			pnnp, 200 mA, NO			DCC 08 M 02 PSK-TSL/32	
M8 x 35	2	f	npn, 200 mA, NC	Stainless steel	2m	DCC 08 M 02 NOLK	
			npn, 200 mA, NO		2m	DCC 08 M 02 NSLK	
			pnnp, 200 mA, NO		10m	DCC 08 M 02 PSLK/10m	
			pnnp, 200 mA, NC		2m	DCC 08 M 02 POLK	
			pnnp, 200 mA, NO		2m	DCC 08 M 02 PSLK	

Housing design Size (mm)	Switching distance (mm)	flush (f) / non-flush (nf) / quasi-flush (qf)	Switching output	Housing material	Cable length, plug connector	Product description	
<b>INE Extended, Thread design</b>							
	M8 x 35	4	nf	npn, 200 mA, NC npn, 200 mA, NO pnp, 200 mA, NC pnp, 200 mA, NO	Stainless steel	2m DCC 08 V 04NB NOLK DCC 08 V 04NB NSLK DCC 08 V 04NB POLK DCC 08 V 04NB PSLK	
	M8 x 35.5	2	f	npn, 200 mA, NO pnp, 200 mA, NO	Nickel-plated brass	2m DCBK 08 MB 02 NS-3 DCBK 08 MB 02 PS-3	
	M8 x 35.5	4	nf	npn, 200 mA, NO pnp, 200 mA, NO	Nickel-plated brass	2m DCBK 08 MN 04 NS-3 DCBK 08 MN 04 PS-3	
	M8 x 40	2	f	npn, 200 mA, NO	Nickel-plated brass	M8	DCBK 08 MB 02 NS-T3
				npn, 200 mA, NC	Stainless steel		DCC 08 M 02 NOK-TSL/40
				npn, 200 mA, NO	Stainless steel		DCC 08 M 02 NSK-TSL/40
				pnp, 200 mA, NO	Nickel-plated brass		DCBK 08 MB 02 PS-T3
				pnp, 200 mA, NC	Stainless steel		DCC 08 M 02 POK-TSL/40
	M8 x 40	4	nf	npn, 200 mA, NO pnp, 200 mA, NO	Nickel-plated brass	M8 DCBK 08 MN 04 NS-T3 DCBK 08 MN 04 PS-T3	
	M8 x 45	3	f	npn, 200 mA, NC	Brass	2m	DCC 08 M 03 NOLK
				npn, 200 mA, NO			DCC 08 M 03 NSLK
				pnp, 200 mA, NC			DCC 08 M 03 POLK
				pnp, 200 mA, NO			DCC 08 M 03 PSLK
	M8 x 45	3	f	pnp, 200 mA, NO	Brass	2 m, M12	DCC 08 M 03 PSK-K2.0-IBSL
	M8 x 45	4	nf	npn, 200 mA, NC	Stainless steel	M8	DCC 08 V 04NB NOK-TSL
				npn, 200 mA, NO			DCC 08 V 04NB NSK-TSL
				pnp, 200 mA, NC			DCC 08 V 04NB POK-TSL
				pnp, 200 mA, NO			DCC 08 V 04NB PSK-TSL
	M8 x 45	6	nf	npn, 200 mA, NC	Chrome-plated brass	2m	DCC 08 M 06 NOLK
				npn, 200 mA, NO			DCC 08 M 06 NSLK
pnp, 200 mA, NC				DCC 08 M 06 POLK			
pnp, 200 mA, NO				DCC 08 M 06 PSLK			
M8 x 45.5	2	f	npn, 200 mA, NO	Nickel-plated brass	2m	DCB 08 MB 02 NS-3	
			pnp, 200 mA, NO			DCB 08 MB 02 PS-3	
M8 x 45.5	4	nf	npn, 200 mA, NO	Nickel-plated brass	2m	DCB 08 MN 04 NS-3	
			pnp, 200 mA, NO			DCB 08 MN 04 PS-3	
M8 x 50	2	f	npn, 200 mA, NO	Nickel-plated brass	M8	DCB 08 MB 02 NS-T3	
			pnp, 200 mA, NO			DCB 08 MB 02 PS-T3	
			pnp, 200 mA, NO			DCB 08 MB 02 P0-T3	
M8 x 50	4	nf	npn, 200 mA, NO	Nickel-plated brass	M8	DCB 08 MN 04 NS-T3	
			pnp, 200 mA, NO			DCB 08 MN 04 PS-T3	
M8 x 50	3	f	npn, 200 mA, NC	Brass	M8	DCC 08 M 03 NOK-TSL	
			npn, 200 mA, NO			DCC 08 M 03 NSK-TSL	
M8 x 60	3	f	pnp, 200 mA, NO	Brass	M8	DCC 08 M 03 PSK-TSL	
			pnp, 200 mA, NC			DCC 08 M 03 POK-TSL	
M8 x 60	6	nf	npn, 200 mA, NC	Chrome-plated brass	M8	DCC 08 M 06 NOK-TSL	
			npn, 200 mA, NO			DCC 08 M 06 NSK-TSL	
			pnp, 200 mA, NC			DCC 08 M 06 POK-TSL	
			pnp, 200 mA, NO			DCC 08 M 06 PSK-TSL	



	Housing design Size (mm)	Switching distance (mm)	flush (f) / non-flush (nf) / quasi-flush (qf)	Switching output	Housing material	Cable length, plug connector	Product description
<b>INE Extended, Thread design</b>							
	M8 x 66	3	f	npn, 200 mA, NC	Brass	M12	DCC 08 M 03 NOK-IBSL
				npn, 200 mA, NO			DCC 08 M 03 NSK-IBSL
				pnp, 200 mA, NC			DCC 08 M 03 POK-IBSL
				pnp, 200 mA, NO			DCC 08 M 03 PSK-IBSL
	M8 x 66	6	nf	npn, 200 mA, NC	Chrome-plated brass	M12	DCC 08 M 06 NOK-IBSL
				npn, 200 mA, NO			DCC 08 M 06 NSK-IBSL
				pnp, 200 mA, NC			DCC 08 M 06 POK-IBSL
				pnp, 200 mA, NO			DCC 08 M 06 PSK-IBSL
<b>INE Extended, Rectangular design</b>							
	8 x 8 x 40	3	qf	npn, 200 mA, NC	Nickel-plated brass	2m	DCCQ 08 M 03 NOLK
				npn, 200 mA, NO			DCCQ 08 M 03 NSLK
				pnp, 200 mA, NC			DCCQ 08 M 03 POLK
				pnp, 200 mA, NO			DCCQ 08 M 03 PSLK
8 x 8 x 60	3	qf	npn, 200 mA, NC	Nickel-plated brass	M8	DCCQ 08 M 03 NOK-TSL	
			npn, 200 mA, NO			DCCQ 08 M 03 NSK-TSL	
			pnp, 200 mA, NC			DCCQ 08 M 03 POK-TSL	
			pnp, 200 mA, NO			DCCQ 08 M 03 PSK-TSL	
	16 x 10 x 28	2	f	npn, 200 mA, NC	Plastic	2m	DCR 30 K 02 NOLK
				npn, 200 mA, NO			DCR 30 K 02 NSLK
				pnp, 200 mA, NC			DCR 30 K 02 POLK
				pnp, 200 mA, NO			DCR 30 K 02 PSLK
	16 x 10 x 28	2	f	npn, 200 mA, NO	Plastic	M8	DCR 30 K 02 NSK-TSL
				pnp, 200 mA, NC			DCR 30 K 02 POK-TSL
				pnp, 200 mA, NO			DCR 30 K 02 PSK-TSL
				npn, 200 mA, NO			DCR 40 K 02 NSLK
	40 x 26 x 12	2	f	pnp, 200 mA, NC	Plastic	2m	DCR 40 K 02 POLK
				pnp, 200 mA, NO			DCR 40 K 02 PSLK
				npn, 200 mA, NO			DCR 40 K 02 NSK-TSL
				pnp, 200 mA, NC			DCR 40 K 02 POK-TSL
40 x 26 x 12	2	f	pnp, 200 mA, NO	Plastic	M8	DCR 40 K 02 PSK-TSL	
			npn, 200 mA, NO			DCR 40 K 04 V PSLK	
			pnp, 200 mA, NC			DCR 40 K 04 POLK	
			pnp, 200 mA, NO			DCR 40 K 04 PSLK	
40 x 26 x 12	4	nf	npn, 200 mA, NC	Plastic	M8	DCR 40 K 04 NOK-TSL	
			npn, 200 mA, NO			DCR 40 K 04 NSK-TSL	
			pnp, 200 mA, NO			DCR 40 K 04 V PSK-TSL	
			pnp, 200 mA, NC			DCR 40 K 04 POK-TSL	
	40 x 40 x 67	20	f	pnp, 200, antivalent	Plastic PA	M12	DCCR 44 K 20 PSOL-IBS
		40	nf				DCCR 44 K 40 PSOL-IBS
	40 x 40 x 118	20	f	pnp, 200 mA, antivalent	Plastic PA	M12	DCCR 40 K 20 PSOL-KL
			nf	pnp, 200 mA, antivalent			DCCR 40 K 40 PSOL-KL
<b>INE Extended, Cylinder design</b>							
	Ø6.5 x 35	4	nf	pnp, 200 mA, NO	Stainless steel	2m	DCC 6.5 V 04 PSLK

Housing design Size (mm)	Switching distance (mm)	flush (f) / non-flush (nf) / quasi-flush (qf)	Switching output	Housing material	Cable length, plug connector	Product description
<b>INE Extended, Cylinder design</b>						
Ø6.5 x 16	1.5	f	nnp, 200 mA, NC	Stainless steel	2 m	DCCCKR 6.5 V 1.5 NOLK
			nnp, 200 mA, NO			DCCCKR 6.5 V 1.5 NSLK
			npn, 200 mA, NC			DCCCK 6.5 V 1.5 POLK
			npn, 200 mA, NO			DCCCK 6.5 V 1.5 PSLK
			pnp, 200 mA, NO			DCCCKR 6.5 V 1.5 PSLK/PUR
			pnp, 200 mA, NC			DCCCKR 6.5 V 1.5 POLK
			pnp, 200 mA, NO			DCCCKR 6.5 V 1.5 PSLK
Ø6.5 x 16	2	f	nnp, 200 mA, NC	Stainless steel	2 m	DCCCK 6.5 V 02 NOLK
			nnp, 200 mA, NO			DCCCKR 6.5 V 02 NOLK
			npn, 200 mA, NO			DCCCKR 6.5 V 02 NSLK
			npn, 200 mA, NO			DCCCK 6.5 V 02 NSLK
			pnp, 200 mA, NC			DCCCKR 6.5 V 02 POLK
			pnp, 200 mA, NC			DCCCK 6.5 V 02 POLK
			pnp, 200 mA, NO			DCCCKR 6.5 V 02 PSLK
Ø6.5 x 16	2	f	pnp, 200 mA, NO	Stainless steel	0.3 m, M8	DCCCKR 6.5 V 02 PSK-K-TSL
Ø6.5 x 22	2	f	nnp, 200 mA, NC	Stainless steel	2 m	DCC 6.5 V 02 NOLK/22
			nnp, 200 mA, NO			DCC 6.5 V 02 NSLK/22
			pnp, 200 mA, NC			DCC 6.5 V 02 POLK/22
			pnp, 200 mA, NO			DCC 6.5 V 02 PSLK/22
Ø6.5 x 22	2	f	nnp, 200 mA, NC	Stainless steel	2 m	DCC 6.5 V 02 NOLK/30
			nnp, 200 mA, NO			DCC 6.5 V 02 NSLK/30
			pnp, 200 mA, NC			DCC 6.5 V 02 POLK/30
			pnp, 200 mA, NO			DCC 6.5 V 02 PSLK/30
Ø6.5 x 30	2	f	nnp, 200 mA, NC	Stainless steel	M8	DCC 6.5 V 02 NOK-TSL/29
			pnp, 200 mA, NC			DCC 6.5 V 02 POK-TSL/29
			pnp, 200 mA, NO			DCC 6.5 V 02 PSK-TSL/29
Ø6.5 x 32	2	f	pnp, 200 mA, NC	Stainless steel V2A	M8	DCC 6.5 V 02 POK-TSL/34
			pnp, 200 mA, NO			DCC 6.5 V 02 PSK-TSL/34
Ø6.5 x 35	2	f	nnp, 200 mA, NC	Stainless steel	2 m	DCC 6.5 V 02 NOLK
			nnp, 200 mA, NO			DCC 6.5 V 02 NSLK
			pnp, 200 mA, NC			DCC 6.5 V 02 POLK
			pnp, 200 mA, NO			DCC 6.5 V 02 PSLK
Ø6.5 x 40	2	f	nnp, 200 mA, NC	Stainless steel	M8	DCC 6.5 V 02 NOK-TSL/40
			nnp, 200 mA, NO			DCC 6.5 V 02 NSK-TSL/40
			pnp, 200 mA, NC			DCC 6.5 V 02 POK-TSL/40
			pnp, 200 mA, NO			DCC 6.5 V 02 PSK-TSL/40
Ø6.5 x 45	2	f	pnp, 200 mA, NO	Stainless steel V2A	M12	DCC 6.5 V 02 PSK-IBSL
Ø6.5 x 45	2.5	f	pnp, 200 mA, NO	Chrome-plated brass	2 m	DCC 6.5 V 2.5 PSLK-E
			nnp, 200 mA, NC			DCC 6.5 M 03 NOLK
			pnp, 200 mA, NC			DCC 6.5 M 03 POLK
Ø6.5 x 45	3	f	pnp, 200 mA, NO	Brass	2 m	DCC 6.5 M 03 PSLK
			pnp, 200 mA, NO			DCC 6.5 M 03 PSLK
Ø6.5 x 45	4	nf	pnp, 200 mA, NO	Stainless steel V2A	M8	DCC 6.5 V 04 PSK-TSL
Ø6.5 x 60	3	f	nnp, 200 mA, NC	Brass	M8	DCC 6.5 M 03 NOK-TSL
			nnp, 200 mA, NO			DCC 6.5 M 03 NSK-TSL
			pnp, 200 mA, NC			DCC 6.5 M 03 POK-TSL
			pnp, 200 mA, NO			DCC 6.5 M 03 PSK-TSL
Ø8 x 16	2	f	pnp, 200 mA, NO	Chrome-plated brass	0.2 m, M8	DCC 8.0 M 02 PSK-KR-TSL

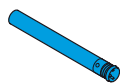

## INC ADVANCED

The sensors in our INC Advanced series guarantee precise, process-reliable object detection at a maximum of 4x distance. With these sensors, switching distances of 8 mm (with M12 flush design) up to 40 mm (with M30, flush design) can be implemented for ambitious applications.



Technical data (typ.)	+20 °C, 24 VDC
Installation instructions	flush (f) / non-flush (nf) (see page 37)
For more information, visit	<a href="http://www.di-soric.com">www.di-soric.com</a>

	Housing design Size (mm)	Switching distance (mm)	flush (f) / non-flush (nf) / quasi-flush (qf)	Switching output	Housing material	Cable length, plug connector	Product description
	M8 x 45	4	f	npn, 200 mA, NC	Chrome-plated nickel-silver	2m	DCC 08 M 04 NOLK
				npn, 200 mA, NO			DCC 08 M 04 NSLK
				pnnp, 200 mA, NC			DCC 08 M 04 POLK
				pnnp, 200 mA, NO			DCC 08 M 04 PSLK
	M8 x 60	4	f	npn, 200 mA, NC	Chrome-plated nickel-silver	M8	DCC 08 M 04 NOK-TSL
				npn, 200 mA, NO			DCC 08 M 04 NSK-TSL
				pnnp, 200 mA, NC			DCC 08 M 04 POK-TSL
				pnnp, 200 mA, NO			DCC 08 M 04 PSK-TSL
	M8 x 66	4	f	npn, 200 mA, NC	Chrome-plated nickel-silver	M12	DCC 08 M 04 NOK-IBSL
				npn, 200 mA, NO			DCC 08 M 04 NSK-IBSL
				pnnp, 200 mA, NC			DCC 08 M 04 POK-IBSL
				pnnp, 200 mA, NO			DCC 08 M 04 PSK-IBSL
	M12 x 50	8	qf	npn, 200 mA, NC	Chrome-plated brass	2m	DCC 12 M 08 NOLK
				npn, 200 mA, NO			DCC 12 M 08 NSLK
pnnp, 200 mA, NC				DCC 12 M 08 POLK			
pnnp, 200 mA, NO				DCC 12 M 08 PSLK			
M12 x 60	8	qf	npn, 200 mA, NC	Chrome-plated brass	M12	DCC 12 M 08 NOK-IBSL	
			npn, 200 mA, NO			DCC 12 M 08 NSK-IBSL	
			pnnp, 200 mA, NC			DCC 12 M 08 POK-IBSL	
			pnnp, 200 mA, NO			DCC 12 M 08 PSK-IBSL	
M30 x 60	40	nf	npn, 200 mA, NC	Chrome-plated brass	2m	DCC 30 M 40 NOLK	
			npn, 200 mA, NO			DCC 30 M 40 NSLK	
			pnnp, 200 mA, NC			DCC 30 M 40 POLK	
			pnnp, 200 mA, NO			DCC 30 M 40 PSLK	
M30 x 73.5	40	nf	npn, 200 mA, NC	Chrome-plated brass	M12	DCC 30 M 40 NOK-IBSL	
			npn, 200 mA, NO			DCC 30 M 40 NSK-IBSL	
			pnnp, 200 mA, NC			DCC 30 M 40 POK-IBSL	
			pnnp, 200 mA, NO			DCC 30 M 40 PSK-IBSL	



## INW FULL METAL EXTENDED

These sensors are robust, fully metallic sensors for challenging applications. They are a secure choice for solutions that pose increased risk of mechanical contact with the detected objects and metallic parts. INW sensors have double and triple switching distances and can be connected with PUR cables or plugs.



Technical data (typ.)	+20 °C, 24 VDC
Installation instructions	flush (f) / non-flush (nf) (see page 37)
For more information, visit	<a href="http://www.di-soric.com">www.di-soric.com</a>

	Housing design Size (mm)	Switching distance (mm)	flush (f) / non-flush (nf) / quasi-flush (qf)	Switching output	Housing material	Protection type	Cable length, plug connector	Product description
	M8 x 45	2	f	npn, 200 mA, NO pnp, 200 mA, NO	Stainless steel V2A	IP 68	2m	D7B 08 VB 02 NS-3 D7B 08 VB 02 PS-3
	M8 x 45	3	f	npn, 200 mA, NO pnp, 200 mA, NO pnp, < 200 mA, NC	Stainless steel Stainless steel Stainless steel V2A	IP 68 IP 68 IP 68, IP 69K	2m	D7C 08 V 03 NSLK D7C 08 V 03 PSLK INW-M08-B03PO-2R
	M8 x 45	6	nf	npn, 200 mA, NO pnp, 200 mA, NO	Stainless steel	IP 68	2m	D7C 08 V 06 NSLK D7C 08 V 06 PSLK
	M8 x 60	2	f	npn, 200 mA, NO pnp, 200 mA, NO	Stainless steel V2A	IP 67	M8	D7B 08 VB 02 NS-T3 D7B 08 VB 02 PS-T3
	M8 x 60	3	f	npn, 200 mA, NO pnp, 200 mA, NO	Stainless steel	IP 67	M8	D7C 08 V 03 NSK-TSL D7C 08 V 03 PSK-TSL
	M8 x 60	6	nf	npn, 200 mA, NO pnp, 200 mA, NC pnp, 200 mA, NO	Stainless steel	IP 67	M8	D7C 08 V 06 NSK-TSL D7C 08 V 06 POK-TSL D7C 08 V 06 PSK-TSL
	M8 x 66	3	f	npn, 200 mA, NC npn, 200 mA, NO pnp, 200 mA, NC pnp, 200 mA, NO	Stainless steel	IP 67	M12	D7C 08 V 03 NOK-IBSL D7C 08 V 03 NSK-IBSL D7C 08 V 03 POK-IBSL D7C 08 V 03 PSK-IBSL
	M8 x 66	6	nf	npn, 200 mA, NC npn, 200 mA, NO pnp, 200 mA, NC pnp, 200 mA, NO	Stainless steel	IP 67	M12	D7C 08 V 06 NOK-IBSL D7C 08 V 06 NSK-IBSL D7C 08 V 06 POK-IBSL D7C 08 V 06 PSK-IBSL
	M12 x 50	4	nf	npn, 200 mA, NO pnp, 200 mA, NO	Stainless steel	IP 69K	2m	D7C 12 V 04 NSLK D7C 12 V 04 PSLK
	M12 x 51	3	f	npn, 200 mA, NO pnp, 200 mA, NO	Stainless steel V2A	IP 68, IP 69K	2m	D7B 12 VB 03 NS-3 D7B 12 VB 03 PS-3
	M12 x 51	6	f	npn, 200 mA, NC npn, 200 mA, NO pnp, 200 mA, NC pnp, 200 mA, NO	Stainless steel	IP 69K	2m	D7C 12 V 06 NOLK D7C 12 V 06 NSLK D7C 12 V 06 POLK D7C 12 V 06 PSLK
	M12 x 51	10	nf	npn, 200 mA, NC npn, 200 mA, NO pnp, 200 mA, NC pnp, 200 mA, NO	Stainless steel	IP 69K	2m	D7C 12 V 10 NOLK D7C 12 V 10 NSLK D7C 12 V 10 POLK D7C 12 V 10 PSLK

	Housing design Size (mm)	Switching distance (mm)	flush (f) / non-flush (nf) / quasi-flush (qf)	Switching output	Housing material	Protection type	Cable length, plug connector	Product description	
<b>INW Full Metal Extended, Thread design</b>									
	M12 x 60	3	f	npn, 200 mA, NO pnp, 200 mA, NO	Stainless steel V2A	IP 68, IP 69K	M12	D7B 12 VB 03 NS-B3 D7B 12 VB 03 PS-B3	
	M12 x 60	4	nf	pnp, 200 mA, NO	Stainless steel	IP 68	M12	D7C 12 V 04 PSK-IBSL	
	M12 x 60	6	f	npn, 200 mA, NC	Stainless steel	IP 68	M12	D7C 12 V 06 NOK-IBSL	
				npn, 200 mA, NO				D7C 12 V 06 NSK-IBSL	
				pnp, 200 mA, NC				D7C 12 V 06 POK-IBSL	
	M12 x 60	10	nf	pnp, 200 mA, NO	Stainless steel	IP 68	M12	D7C 12 V 06 PSK-IBSL	
				npn, 200 mA, NC				D7C 12 V 10 NOK-IBSL	
				npn, 200 mA, NO				D7C 12 V 10 NSK-IBSL	
		M18 x 51	5	f	npn, 200 mA, NO pnp, 200 mA, NO	Stainless steel V2A	IP 68, IP 69K	2m	D7B 18 VB 05 NS-3 D7B 18 VB 05 PS-3
		M18 x 51	8	nf	npn, 200 mA, NO pnp, 200 mA, NO pnp, 200 mA, NC	Stainless steel	IP 69K	2m	D7C 18 V 08 NSLK D7C 18 V 08 PSLK D7C 18 V 08 POLK
		M18 x 35	10	f	pnp, 200 mA, NO	Stainless steel	IP 68, IP 69K	2m	D7CK 18 V 10 PSLK
					npn, 200 mA, NC	Stainless steel	IP 69K	2m	D7C 18 V 10 NOLK
npn, 200 mA, NO					Stainless steel	IP 69K	2m	D7C 18 V 10 NSLK	
pnp, 200 mA, NC					Stainless steel	IP 69K	2m	D7C 18 V 10 POLK	
M18 x 51		20	nf	pnp, 200 mA, NO	Stainless steel	IP 69K	2m	D7C 18 V 10 PSLK	
				npn, 200 mA, NC				D7C 18 V 20 NOLK	
				npn, 200 mA, NO				D7C 18 V 20 NSLK	
				pnp, 200 mA, NC				D7C 18 V 20 POLK	
		M18 x 63.5	5	f	npn, 200 mA, NO pnp, 200 mA, NO	Stainless steel V2A	IP 68, IP 69K	M12	D7B 18 VB 05 NS-B3 D7B 18 VB 05 PS-B3
		M18 x 63.5	8	nf	npn, 200 mA, NO pnp, 200 mA, NO	Stainless steel	IP 68	M12	D7C 18 V 08 NSK-IBSL D7C 18 V 08 PSK-IBSL
	M18 x 63.5	10	f	npn, 200 mA, NC	Stainless steel	IP 68	M12	D7C 18 V 10 NOK-IBSL	
				npn, 200 mA, NO				D7C 18 V 10 NSK-IBSL	
				pnp, 200 mA, NC				D7C 18 V 10 POK-IBSL	
	M18 x 63.5	20	nf	pnp, 200 mA, NO	Stainless steel V2A	IP 68	M12	D7C 18 V 10 PSK-IBSL	
				npn, 200 mA, NC				D7C 18 V 20 NOK-IBSL	
				npn, 200 mA, NO				D7C 18 V 20 NSK-IBSL	
	M18 x 63.5	20	nf	pnp, 200 mA, NC	Stainless steel V2A	IP 68	M12	D7C 18 V 20 POLK	
				pnp, 200 mA, NO				D7C 18 V 20 POK-IBSL	
				npn, 200 mA, NO				D7C 18 V 20 PSK-IBSL	

	Housing design Size (mm)	Switching distance (mm)	flush (f) / non-flush (nf) / quasi-flush (qf)	Switching output	Housing material	Protection type	Cable length, plug connector	Product description
<b>INW Full Metal Extended, Thread design</b>								
	M30 x 50	10	f	npn, 200 mA, NO pnp, 200 mA, NO	Stainless steel V2A	IP 68, IP 69K	2m	D7B 30 VB 10 NS-3 D7B 30 VB 10 PS-3
	M30 x 51	20	f	pnp, 200 mA, NC pnp, 200 mA, NO	Stainless steel	IP 69K	2m	D7C 30 V 20 POLK D7C 30 V 20 PSLK
	M30 x 51	40	nf	npn, 200 mA, NC pnp, 200 mA, NC pnp, 200 mA, NO	Stainless steel	IP 69K	2m	D7C 30 V 40 NOLK D7C 30 V 40 POLK D7C 30 V 40 PSLK
	M30 x 63.5	10	f	npn, 200 mA, NO pnp, 200 mA, NO	Stainless steel V2A	IP 68, IP 69K	M12	D7B 30 VB 10 NS-B3 D7B 30 VB 10 PS-B3
	M30 x 63.5	20	f	npn, 200 mA, NC npn, 200 mA, NO pnp, 200 mA, NC pnp, 200 mA, NO	Stainless steel	IP 68	M12	D7C 30 V 20 NOK-IBSL D7C 30 V 20 NSK-IBSL D7C 30 V 20 POK-IBSL D7C 30 V 20 PSK-IBSL
	M30 x 63.5	40	nf	npn, 200 mA, NC pnp, 200 mA, NC pnp, 200 mA, NO	Stainless steel	IP 68	M12	D7C 30 V 40 NOK-IBSL D7C 30 V 40 POK-IBSL D7C 30 V 40 PSK-IBSL

## INP HIGH-PRESSURE RESISTANT

Our high-pressure resistant sensors can handle the pressure. They withstand a process pressure up to 500 bar and are available with a stainless steel housing in sizes M12 and M14. They are optimal and safe for position monitoring in hydraulic systems or monitoring of valve positions under high pressure.



Technical data (typ.)	+20 °C, 24 VDC
Pressure resistance	up to 500 bar
Installation instructions	flush (f) / non-flush (nf) (see page 37)
For more information, visit	<a href="http://www.di-soric.com">www.di-soric.com</a>

	Housing design Size (mm)	Switching distance (mm)	Switching output	Housing material	Protection type	Cable length, plug connector	Product description
<b>INP High-pressure resistant, Thread design</b>							
	M12 x 56	1.5	pnp, 200 mA, NO pnp, 200 mA, NO	Stainless steel	IP 68 IP 68	M12	DCC 12 V 1.5 PSK-IBSL 500/56 DCC 12 V 1.5 PSK-IBSL 500/56/17.9 DCC 12 VHD 2 PS-B3-56-4 DCC 12 VHD 2.5 PS-B3-56-17.9
		2	pnp, 200 mA, NO	Stainless steel V2A	IP 68, IP 69K		
		2.5	pnp, 200 mA, NO	Stainless steel	IP 68		
	M12 x 69	1.5	pnp, 200 mA, NO	Stainless steel	IP 68	M12	DCC 12 V 1.5 PSK-IBSL 500/69 DCC 12 VHD 2 PO-B3-69-2 DCC 12 VHD 2 PS-B3-69-2
		2	pnp, 200 mA, NC pnp, 200 mA, NO	Stainless steel V2A	IP 68, IP 69K		
		2.5	pnp, 200 mA, NO	Stainless steel	IP 68		
	M12 x 78	1.5	pnp, 200 mA, NO	Stainless steel	IP 68	M12	DCC 12 V 1.5 PSK-IBSL 500/78 DCC 12 VHD 2 PS-B3-78-7 DCC 12 VHD 2.5 PS-B3-78
		2	pnp, 200 mA, NO	Stainless steel V2A	IP 68, IP 69K		
		2.5	pnp, 200 mA, NO	Stainless steel	IP 68		
	M12 x 93	1.5	pnp, 200 mA, NO	Stainless steel	IP 68	M12	DCC 12 V 1.5 PSK-IBSL 500/93 DCC 12 VHD 2 PS-B3-93-2
2		pnp, 200 mA, NO	Stainless steel V2A	IP 68, IP 69K			
M12 x 98	2	pnp, 200 mA, NO	Stainless steel V2A	IP 68, IP 69K	M12	DCC 12 VHD 2 PS-B3-98-7	
M12 x 127	2	pnp, 200 mA, NO	Stainless steel V2A	IP 68 IP 69K	M12	DCC 12 VHD 2 PS-B3-127-2	
	M14 x 56.5	3	pnp, 200 mA, NO npn, 200 mA, NO pnp, 200 mA, NO	Stainless steel	IP 68	M12	DCC 14 V 03 PSK 500 DCC 14 V 03 NSK 500-IBS DCC 14 V 03 PSK 500-IBS

## INA ANALOG

The Analog series INA includes highly precise inductive proximity sensors which have an analog current and voltage output available. They are suited for measuring switching distances of metallic parts in production or testing processes in which small changes in distance can reflect the quality of the process.



Technical data (typ.)	+20 °C, 24 VDC
Installation instructions	flush (f) / non-flush (nf) (see page 37)
For more information, visit	<a href="http://www.di-soric.com">www.di-soric.com</a>

	Housing design Size (mm)	Switching distance (mm)	flush (f) / non-flush (nf) / quasi-flush (qf)	Analog output	Housing material	Protection type	Cable length, plug connector	Product description
<b>INA Analog, Thread design</b>								
	M8 x 45	0 to 4	qf	0 V to 10 V	Chrome-plated brass	IP 67	2m	DCC 08 M 04/10 AK
	M8 x 60						M8	DCC 08 M 04/10 AK-TSL
	M8 x 66						M12	DCC 08 M 04/10 AK-IBS
	M12 x 36	0 to 6	qf	0 V to 10 V, 4 mA to 20 mA	Nickel-plated brass	IP 67	2m	DCCK 12 M 06/10 AK
	M12 x 45			0 V to 10 V, 4 mA to 20 mA			M12	DCCK 12 M 06/10 AK-IBS
	M12 x 45			0 V to 5 V, 1 mA to 5 mA			M12	DCCK 12 M 06 AIK-IBS
	M12 x 50			0 V to 10 V, 4 mA to 20 mA			2m	DCC 12 M 06 AIK
	M12 x 60			2m			DCC 12 M 06/10 AIK	
				M12			DCC 12 M 06 AIK-IBS	
	M18 x 36	0 to 10	qf	0 V to 10 V, 4 mA to 20 mA	Nickel-plated brass	IP 67	2m	DCCK 18 M 10/10 AIK
	M18 x 48.5						M12	DCCK 18 M 10/10 AIK-IBS
	M18 x 51						2m	DCC 18 M 10/10 AIK
	M18 x 63.5						M12	DCC 18 M 10/10 AIK-IBS
	M18 x 63.4	0 to 20	nf	0 V to 10 V, 4 mA to 20 mA	Nickel-plated brass	IP 67	M12	DCC 18 M 20/10 AIK-IBS
	M30 x 35	0 to 20	qf	0 V to 10 V, 4 mA to 20 mA	Nickel-plated brass	IP 67	2m	DCCK 30 M 20/10 AIK
	M30 x 48.5						M12	DCCK 30 M 20/10 AIK-IBS
	M30 x 60						2m	DCC 30 M 20/10 AIK
	M30 x 73.5						M12	DCC 30 M 20/10 AIK-IBS
	M30 x 35	0 to 20	qf	0 V to 5 V, 1 mA to 5 mA	Nickel-plated brass	IP 67	2m	DCCK 30 M 20 AIK
	M30 x 60						2m	DCC 30 M 20 AIK
	M30 x 73.5						M12	DCC 30 M 20 AIK-IBS
	M30 x 35	0 to 40	nf	0 V to 10 V, 4 mA to 20 mA	Nickel-plated brass	IP 67	2m	DCCK 30 M 40/10 AIK
	M30 x 73.5						M12	DCC 30 M 40/10 AIK-IBS
<b>INA Analog, Rectangular design</b>								
	59 x 8 x 8	0 to 4	qf	0 V to 10 V	Nickel-plated brass	IP 67	2m	DCCQ 08 M 04/10 AK
							M8	DCCQ 08 M 04/10 AK-TSL



## INH HIGH-TEMPERATURE RESISTANT

Our high-temperature resistant INH series satisfies high demands in a compact design. The sensors can be used in ambient temperatures from - 25 °C to + 230 °C.

Technical data (typ.)	+20 °C, 24 VDC
Installation instructions	flush (f) / non-flush (nf) (see page 37)
For more information, visit	www.di-soric.com



	Housing design Size (mm)	Switching distance (mm)	flush (f) / non-flush (nf) / quasi-flush (qf)	Temperature range (°C)	Switching output	Housing material	Protection type	Cable length, plug connector	Product description
<b>INH High-temperature resistant, Thread design</b>									
	M8 x 60	2	f	0 to +140	npn, 120 mA, NO	Stainless steel	IP 65	2m	DCC 08 VH 02 NSK/140
					pnp, 120 mA, NO				DCC 08 VH 02 PSK/140
	M12 x 59	3	f	0 to +150	npn, 120 mA, NO	Stainless steel	IP 65	2m	DCC 12 VH 03 NSK/150
					pnp, 120 mA, NO				DCC 12 VH 03 PSK/150
	M12 x 63	2	f	-25 to +120	pnp, 200 mA, NO	Stainless steel V4A	IP 68	2m	DCE 12 VH 02 PSK
					npnp, 120 mA, NO	Stainless steel V4A	IP 67	2m	DCC 12 VH 04 PSK/150
M12 x 63	4	nf	0 to +150	pnp, 200 mA, NO	Stainless steel V4A	IP 68	DCE 12 VH 04 PSK		
	M18 x 67	5	f	-25 to +120	pnp, 200 mA, NO	Stainless steel V4A	IP 68	2m	DCE 18 VH 05 PSK
					pnp, 200 mA, NO	Stainless steel V4A	IP 68	2m	DCE 18 VH 07 PSK
	M18 x 76	5	f	0 to +180	npn, 150 mA, NO	Stainless steel	IP 65	2m	DCC 18 VH 05 NSK/180
					npn, 200 mA, NO			3m	DCC 18 VH 05 NSK/230/V
					pnp, 200 mA, NO			2m	DCC 18 VH 05 PSK/180
					pnp, 200 mA, NO			3m	DCC 18 VH 05 PSK/230/V
	M18 x 80	5	f	-25 to +160	pnp, 200 mA, NO	Stainless steel V4A	IP 65	2m	DCE 18 VH 05 PSK
	M18 x 82	8	nf	0 to +180	npn, 150 mA, NO	Stainless steel	IP 65	2m	DCC 18 VH 08 NSK/180
pnp, 150 mA, NO					DCC 18 VH 08 PSK/180				
	M30 x 71	10	f	0 to +180	npn, 150 mA, NO	Stainless steel	IP 65	2m	DCC 30 VH 10 NSK/180
					npn, 200 mA, NO			3m	DCC 30 VH 10 NSK/230/V
					pnp, 80 mA, NC			2m	DCC 30 VH 10 POK/180
					pnp, 150 mA, NO			2m	DCC 30 VH 10 PSK/180
					pnp, 200 mA, NO			3m	DCC 30 VH 10 PSK/230/V
					npn, 150 mA, NO			2m	DCC 30 VH 15 NSK/180
	M30 x 79	15	nf	0 to +230	npn, 200 mA, NO	Stainless steel	IP 65	3m	DCC 30 VH 15 NSK/230/V
					pnp, 150 mA, NO			2m	DCC 30 VH 15 PSK/180
					pnp, 200 mA, NO			3m	DCC 30 VH 15 PSK/230/V
					pnp, 200 mA, NO			3m	DCC 30 VH 15 PSK/230/V
M30 x 85	10	f	-25 to +160	pnp, 200 mA, NO	Stainless steel V4A	IP 65	2m	DCE 30 VH 10 PSK	
	M50 x 50	20	qf	0 to +230	npn, 200 mA, NO	Stainless steel	IP 65	3m	DCC 50 VH 20 NSK/230/V
					pnp, 200 mA, NO				DCC 50 VH 20 PSK/230/V
	M50 x 64	25	nf	0 to +230	npn, 200 mA, NO	Stainless steel	IP 65	3m	DCC 50 VH 25 NSK/230/V
					pnp, 200 mA, NO				DCC 50 VH 25 PSK/230/V
	M50 x 70	20	qf	0 to +180	npn, 150 mA, NO	Stainless steel	IP 65	2m	DCC 50 VH 20 NSK/180
					pnp, 150 mA, NO				DCC 50 VH 20 PSK/180
	M50 x 84	25	nf	0 to +180	npn, 150 mA, NO	Stainless steel	IP 65	2m	DCC 50 VH 25 NSK/180
					pnp, 150 mA, NO				DCC 50 VH 25 PSK/180

## INF FOOD & BEVERAGE

The sensors in the INF series are available in the conventional sizes M12, M18 or M30. They feature a completely impermeable, single-piece fully metallic stainless steel housing (V4A / AISI 316L), including the sensor area. This makes them highly resistant to the corrosive chemicals that are used in cleaning or washing.



Technical data (typ.)	+20 °C, 24 VDC
Installation instructions	flush (f) / non-flush (nf) (see page 37)
For more information, visit	www.di-soric.com

	Housing design Size (mm)	Switching distance (mm)	flush (f) / non-flush (nf) / quasi-flush (qf)	Analog output	Housing material	Protection type	Cable length, plug connector	Product description
	M12 x 60	6	f	npn, 200 mA, NO	Stainless steel 1.4435 / AISI 316L	IP 68 IP 69K	M12	DCC 12 VL 06 NOK-IBSL
				npn, 200 mA, NC				DCC 12 VL 06 NSK-IBSL
				pnp, 200 mA, NO				DCC 12 VL 06 POK-IBSL
				pnp, 200 mA, NC				DCC 12 VL 06 PSK-IBSL
	M12 x 60	10	nf	npn, 200 mA, NO	Stainless steel 1.4435 / AISI 316L	IP 68 IP 69K	M12	DCC 12 VL 10 NOK-IBSL
				npn, 200 mA, NC				DCC 12 VL 10 NSK-IBSL
				pnp, 200 mA, NO				DCC 12 VL 10 POK-IBSL
				pnp, 200 mA, NC				DCC 12 VL 10 PSK-IBSL
M12 x 69.2	6	f	npn, 200 mA, NO	Stainless steel 1.4435 / AISI 316L	IP 68 IP 69K	2m	DCC 12 VL 06 NOLK	
			npn, 200 mA, NC				DCC 12 VL 06 NSLK	
			pnp, 200 mA, NO				DCC 12 VL 06 POLK	
			pnp, 200 mA, NC				DCC 12 VL 06 PSLK	
M12 x 69.2	10	nf	npn, 200 mA, NO	Stainless steel 1.4435 / AISI 316L	IP 68 IP 69K	2m	DCC 12 VL 10 NOLK	
			npn, 200 mA, NC				DCC 12 VL 10 NSLK	
			pnp, 200 mA, NO				DCC 12 VL 10 POLK	
			pnp, 200 mA, NC				DCC 12 VL 10 PSLK	
	M18 x 63.5	10	f	npn, 200 mA, NO	Stainless steel 1.4435 / AISI 316L	IP 68 IP 69K	M12	DCC 18 VL 10 NOK-IBSL
				npn, 200 mA, NC				DCC 18 VL 10 NSK-IBSL
				pnp, 200 mA, NO				DCC 18 VL 10 POK-IBSL
				pnp, 200 mA, NC				DCC 18 VL 10 PSK-IBSL
	M18 x 63.5	20	nf	npn, 200 mA, NO	Stainless steel 1.4435 / AISI 316L	IP 68 IP 69K	M12	DCC 18 VL 20 NOK-IBSL
				npn, 200 mA, NC				DCC 18 VL 20 NSK-IBSL
				pnp, 200 mA, NO				DCC 18 VL 20 POK-IBSL
				pnp, 200 mA, NC				DCC 18 VL 20 PSK-IBSL
M18 x 70.2	10	f	npn, 200 mA, NO	Stainless steel 1.4435 / AISI 316L	IP 68 IP 69K	2m	DCC 18 VL 10 NOLK	
			npn, 200 mA, NC				DCC 18 VL 10 NSLK	
			pnp, 200 mA, NO				DCC 18 VL 10 POLK	
			pnp, 200 mA, NC				DCC 18 VL 10 PSLK	
M18 x 70.2	20	nf	npn, 200 mA, NO	Stainless steel 1.4435 / AISI 316L	IP 68 IP 69K	2m	DCC 18 VL 20 NOLK	
			npn, 200 mA, NC				DCC 18 VL 20 NSLK	
			pnp, 200 mA, NO				DCC 18 VL 20 POLK	
			pnp, 200 mA, NC				DCC 18 VL 20 PSLK	

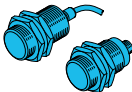

	Housing design Size (mm)	Switching distance (mm)	flush (f) / non-flush (nf) / quasi-flush (qf)	Analog output	Housing material	Protection type	Cable length, plug connector	Product description
<b>INF Food &amp; Beverage, Thread design</b>								
	M30 x 63.5	20	f	npn, 200 mA, NO	Stainless steel 1.4435 / AISI 316L	IP 68 IP 69K	M12	DCC 30 VL 20 NOK-IBSL
				npn, 200 mA, NC				DCC 30 VL 20 NSK-IBSL
				pnp, 200 mA, NO				DCC 30 VL 20 POK-IBSL
				pnp, 200 mA, NC				DCC 30 VL 20 PSK-IBSL
	M30 x 63.5	40	nf	npn, 200 mA, NO	Stainless steel 1.4435 / AISI 316L	IP 68 IP 69K	M12	DCC 30 VL 40 NOK-IBSL
				npn, 200 mA, NC				DCC 30 VL 40 NSK-IBSL
				pnp, 200 mA, NO				DCC 30 VL 40 POK-IBSL
				pnp, 200 mA, NC				DCC 30 VL 40 PSK-IBSL
	M30 x 70.2	20	f	npn, 200 mA, NO	Stainless steel 1.4435 / AISI 316L	IP 68 IP 69K	2m	DCC 30 VL 20 NOLK
				npn, 200 mA, NC				DCC 30 VL 20 NSLK
				pnp, 200 mA, NO				DCC 30 VL 20 POLK
				pnp, 200 mA, NC				DCC 30 VL 20 PSLK
	M30 x 70.2	40	nf	npn, 200 mA, NO	Stainless steel 1.4435 / AISI 316L	IP 68 IP 69K	2m	DCC 30 VL 40 NOLK
				npn, 150 mA, NC				DCC 30 VL 40 NSLK
				pnp, 200 mA, NO				DCC 30 VL 40 POLK
				pnp, 200 mA, NC				DCC 30 VL 40 PSLK

## INN NAMUR

Our process sensors in the INN NAMUR series guarantee high-precision measuring and control without intervention into the process. The measured values are available in real-time via a reliable, easily implementable interface that will be supported over the long term.

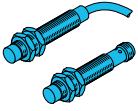

Technical data (typ.)	+20 °C, 24 VDC
Installation instructions	flush (f) / non-flush (nf) (see page 37)
For more information, visit	<a href="http://www.di-soric.com">www.di-soric.com</a>

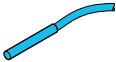
	Housing design Size (mm)	Switching distance (mm)	flush (f) / non-flush (nf) / quasi-flush (qf)	Analog output	Housing material	Protection type	Cable length, plug connector	Product description
<b>INN Namur, Thread design</b>								
	M5 x 25	0.8	f	Namur, < 1 mA	Stainless steel	IP 67	2 m	DCC 05 V 0.8 NAMUR
	M8 x 16	1.5	f	Namur, < 1 mA	Stainless steel	IP 67	2 m	DCC 08 V 1.5 NAMUR
	M8 x 29	1.5	f	Namur, < 1 mA	Stainless steel	IP 67	M8	DCC 08 V 1.5-TSL/NAMUR
<b>INN Namur, Cylinder design</b>								
	Ø4 x 10	0.8	f	Namur, < 1 mA	Stainless steel	IP 67	1 m	DCC 4.0 V 0.8 NAMUR-K
	Ø6.5 x 16	1.5	f	Namur, < 1 mA	Stainless steel	IP 67	2 m	DCCK 6.5 V 1.5 NAMUR
								DCCKR 6.5 V 1.5 NAMUR
	Ø3 x 22	0.6	f	Namur, < 1 mA	Stainless steel	IP 67	2 m	DCC 6.5 V 1.5 NAMUR/ 2m PUR
								DCC 3.0 V 0.6 NAMUR

## INU UNIVERSAL VOLTAGE

The INU all-voltage series can be used for all types of industrial power supply AC/DC, allowing cost and maintenance effort to be significantly reduced. Our all-voltage sensors are available in the standard sizes M12, M18 and M30.



Technical data (typ.)	+20 °C, 24 VDC
Installation instructions	flush (f) / non-flush (nf) (see page 37)
For more information, visit	<a href="http://www.di-soric.com">www.di-soric.com</a>



	Housing design Size (mm)	Switching distance (mm)	flush (f) / non-flush (nf) / quasi-flush (qf)	Analog output	Housing material	Protection type	Cable length, plug connector	Product description
<b>INU Universal Voltage, Thread design</b>								
	M12 x 70	2	f	200 mA, AC/DC 200 mA, AC/DC	Brass	IP 67	2m	UCC 12 M 02 OL UCC 12 M 02 SL
	M12 x 70	4	nf	200 mA, AC/DC 200 mA, AC/DC	Brass	IP 67	2m	UCC 12 M 04 OL UCC 12 M 04 SL
	M12 x 75	2	f	200 mA, AC/DC 200 mA, AC/DC	Brass	IP 67	M12	UCC 12 M 02 0-IBSL UCC 12 M 02 S-IBSL
	M12 x 75	4	nf	200 mA, AC/DC 200 mA, AC/DC	Brass	IP 67	M12	UCC 12 M 04 0-IBSL UCC 12 M 04 S-IBSL
	M18 x 60	8	nf	200 mA, AC/DC 200 mA, AC/DC	Brass	IP 67	2m	UCC 18 M 08 OL UCC 18 M 08 SL
	M18 x 61	5	f	200 mA, AC/DC 200 mA, AC/DC	Brass	IP 67	2m	UCC 18 M 05 OL UCC 18 M 05 SL
	M18 x 80	5	f	200 mA, AC/DC 200 mA, AC/DC	Brass	IP 67	M12	UCC 18 M 05 0-IBSL UCC 18 M 05 S-IBSL
	M18 x 80	8	nf	200 mA, AC/DC 200 mA, AC/DC	Brass	IP 67	M12	UCC 18 M 08 0-IBSL UCC 18 M 08 S-IBSL
	M30 x 60	10	f	200 mA, AC/DC 200 mA, AC/DC	Brass	IP 67	2m	UCC 30 M 10 OL UCC 30 M 10 SL
	M30 x 60	15	nf	200 mA, AC/DC 200 mA, AC/DC	Brass	IP 67	2m	UCC 30 M 15 OL UCC 30 M 15 SL
	M30 x 80	10	f	200 mA, AC/DC 200 mA, AC/DC	Brass	IP 67	M12	UCC 30 M 10 0-IBSL UCC 30 M 10 S-IBSL
	M30 x 80	15	nf	200 mA, AC/DC	Brass	IP 67	M12	UCC 30 M 15 S-IBSL
<b>INU Universal Voltage, Rectangular design</b>								
	41 x 41 x 120	20mm	f	400 mA, AC/DC	Plastic PA	IP 54		UCCR 40 K 20 S0-KL

## INZ SPECIAL APPLICATIONS

Our inductive proximity sensors in the INZ series are suitable for many special applications, such as those in the low temperature range.

<b>Technical data (typ.)</b>	<b>+20 °C, 24 VDC</b>
Installation instructions	flush (f) / non-flush (nf) (see page 37)
For more information, visit	<a href="http://www.di-soric.com">www.di-soric.com</a>



	Housing design Size (mm)	Switching distance (mm)		Temperature range (°C)	Switching output	Housing material	Protection type	Cable length, plug connector	Product description
		flush (f) / non-flush (nf) / quasi-flush (qf)							
	M12 x 63	2	f	-55 to +60	pnp, 200 mA, NO	Stainless steel V4A 1.4571 / AISI 316Ti	IP 68 IP 69K	2 m	DCE 12 VT 02 PSK
		4	nf						DCE 12 VT 04 PSK
	M18 x 67	5	f	-55 to +60	pnp, 200 mA, NO	Stainless steel V4A 1.4571 / AISI 316Ti	IP 68 IP 69K	2 m	DCE 18 VT 05 PSLK
		7	nf						DCE 18 VT 07 PSLK

## INSTALLATION INSTRUCTIONS FOR INDUCTIVE PROXIMITY SENSORS

### Flush installation (f)

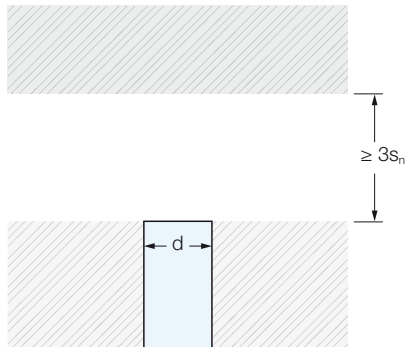

These proximity switches can be installed in all materials (metals / non-metals) such that the active sensor surface lines up flush with the surrounding material on the front side.

They have the following advantages:

- Flush installation in conductive materials (metals)
- Protection of the sensing surface prior to mechanical damage
- Less influence from external interference fields
- Less distance to the next proximity switch on the side

### Non-flush installation (nf)

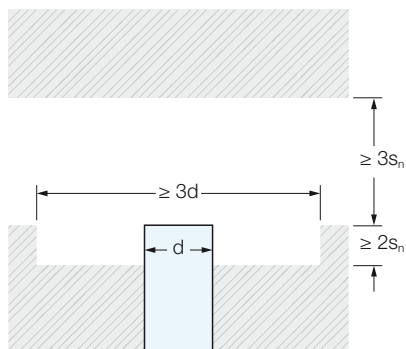

These proximity switches are allowed to be installed non-flush in conductive materials.

They have the greatest possible switching distance. Special installation instructions apply to these proximity switches.

Flush installation in nonconductive materials is permitted.

### Quasi-flush installation (qf)

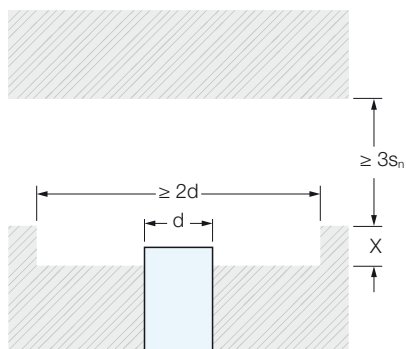

These proximity switches have a greater switching distance than proximity switches for flush installation. However, they are only allowed to be installed quasi-flush in conductive materials, i.e. not entirely flush. The proximity switches must protrude from the installation surface by dimension X (see the Installation instructions).

Flush installation in nonconductive materials is permitted.

## Inductive ring sensors

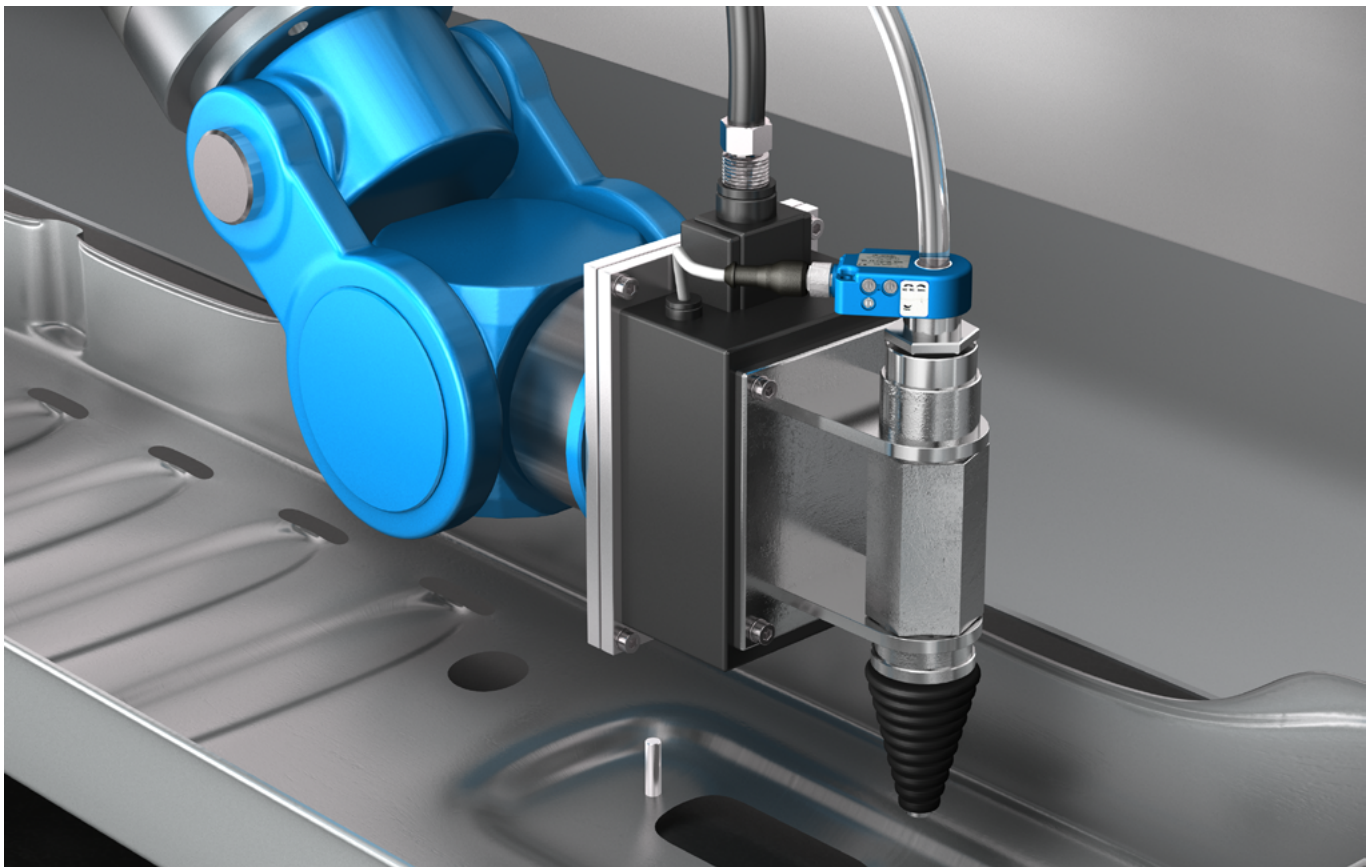

Our inductive ring and wire breakage sensors detect the smallest metallic parts that are conveyed in supply tubes for further processing. In the case of parts that are fed very quickly, the integrated pulse stretching generates an output signal that can be easily analyzed. All devices from di-soric are reliably protected against overload, short-circuit and polarity reversal.



 **di-soric**

IRB Standard	39
IR Static	40
IRD Dynamic	42
IRDB Wire break sensor	43
IR-Z Accessories for inductive ring sensors	43





## IRB STANDARD

The inductive ring sensors in the IRB Standard series in the sizes Ø 10.1 mm to 27 mm detect the smallest metallic parts. They can be put into service quickly and have no adjusting elements. These sensors work according to the static operating principle and exhibit a short response time.

Technical data (typ.)	+20 °C, 24 VDC
Service voltage	10 to 35 V DC
Voltage drop	2.0 V
Speed of parts	< 35 m/s
Ambient temperature	-25 to 70 °C
Protection type	IP 67
Insulation voltage endurance	1,000 V
Housing material	Polyamide, ring POM



	Ring diameter (mm)	Evaluation: Static (S)	No-load current (mA)	Resolution, steel ball (mm)	Switching output	Pulse stretching (ms)	Cable length, Plug connector	Product description
	10.1	T	11	2.0	pnp, 200 mA, NO	150	M12	IRB 10 PS-B3
					nnp, 200 mA, NO			IRB 10 NS-B3
	15.1	T	11	2.5	pnp, 200 mA, NO	150	M12	IRB 15 PS-B3
					nnp, 200 mA, NO			IRB 15 NS-B3
	20.1	T	11	3.0	pnp, 200 mA, NO	150	M12	IRB 20 PS-B3
					nnp, 200 mA, NO			IRB 20 NS-B3
	27.1	T	11	5.0	pnp, 200 mA, NO	150	M12	IRB 27 PS-B3







## IR STATIC

The devices in the IR series are inductive standard ring sensors that can be used to detect even the smallest metallic parts. They are available in Ø 6.1 mm to 151.0 mm models and are well suited for quickly supplied parts.



Technical data (typ.)	+20 °C, 24 VDC
Service voltage	10 to 35 V DC
Sensitivity adjustment	Potentiometer
Voltage drop	2.0 V
Speed of parts	< 35 m/s
Ambient temperature	-25 to 70 °C
Protection type	IP 67
Insulation voltage endurance	1,000V
Housing material	Polyamide, ring POM
	Die-cast aluminum, ring POM (only IR 150 ...)

	Ring diameter (mm)	Evaluation: Static (S) / Dynamic (D)	No-load current (mA)	Resolution, steel ball (mm)	Switching output	Pulse stretching (ms)	Cable length, Plug connector	Product description
	6.1	T	11	1.0	pnp, 200 mA, NO/NC	10 to 150	M12	IR 6 PSOK-IBS
					npn, 200 mA, NO/NC			IR 6 NSOK-IBS
					pnp, 200 mA, NO/NC		0.3m/M12	IR 6 PSOK-K-BS
	10.1	T	11	1.5	pnp, 200 mA, NO/NC	10 to 150	M12	IR 10 PSOK-IBS
					pnp, 200 mA, NO/NC			IR 10 NSOK-IBS
					pnp, 200 mA, NO/NC		0.3m/M12	IR 10 PSOK-K-BS
	15.1	T	11	2.0	pnp, 200 mA, NO/NC	10 to 150	M12	IR 15 PSOK-IBS
					pnp, 200 mA, NO/NC			IR 15 NSOK-IBS
					pnp, 200 mA, NO/NC		0.3m/M12	IR 15 PSOK-K-BS

	Ring diameter (mm)	Evaluation: Static (S) / Dynamic (D)	No-load current (mA)	Resolution, steel ball (mm)	Switching output	Pulse stretching (ms)	Cable length, Plug connector	Product description
<b>IR Static</b>								
	20.1	T	11	2.5	pnp, 200 mA, NO/NC	10 to 150	M12	IR 20 PSOK-IBS
					nnp, 200 mA, NO/NC			IR 20 NSOK-IBS
					pnp, 200 mA, NO/NC			0.3m/M12
	25.1	T	11	3.0	pnp, 200 mA, NO/NC	10 to 150	M12	IR 25 PSOK-IBS
					nnp, 200 mA, NO/NC			IR 25 NSOK-IBS
					pnp, 200 mA, NO/NC			0.3m/M12
	35.2	T	11	4.5	pnp, 200 mA, NO/NC	10 to 150	M12	IR 35 PSOK-IBS
					nnp, 200 mA, NO/NC			IR 35 NSOK-IBS
	51.0	T	11	6.0	pnp, 200 mA, NO/NC	10 to 150	M12	IR 50 PSOK-IBS
					nnp, 200 mA, NO/NC			IR 50 NSOK-IBS
	101.0	T	15	10.0	pnp, 200 mA, NO/NC	10 to 150	M12	IR 100 PSOK-IBS
					nnp, 200 mA, NO/NC			IR 100 NSOK-IBS
	151.0	T	15	19.0	pnp, 200 mA, NO/NC	10 to 150	M12	IR 150 PSOK-IBS
					nnp, 200 mA, NO/NC			IR 150 NSOK-IBS

## IRD DYNAMIC

Ring sensors with dynamic evaluation have a higher resolution than ring sensors with static resolution, making them particularly suitable for detecting very small parts with a low mass. The dynamic operating principle independently compensates for contamination in the supply tube.



Technical data (typ.)	+20 °C, 24 VDC
Service voltage	10 to 35 V DC
Sensitivity adjustment	Potentiometer
Voltage drop	2.0V
Speed of parts	<35 m/s
Ambient temperature	-25 to 70 °C
Protection type	IP 67
Insulation voltage endurance	1,000V
Housing material	Polyamide, ring POM
	Die-cast aluminum, ring POM (only IRD 150 ...)

	Ring diameter (mm)	Evaluation: Static (S) / Dynamic (D)	No-load current (mA)	Resolution, steel ball (mm)	Switching output	Pulse stretching (ms)	Cable length, Plug connector	Product description
	6.1	D	<20	0.5	pnp, 200 mA, NO/NC	0.1 to 150	M12	IRD 6 PSOK-IBS
					npn, 200 mA, NO/NC			IRD 6 NSOK-IBS
	10.1	D	<20	0.6	pnp, 200 mA, NO/NC	0.1 to 150	M12	IRD 10 PSOK-IBS
					npn, 200 mA, NO/NC			IRD 10 NSOK-IBS
	15.1	D	<20	0.8	pnp, 200 mA, NO/NC	0.1 to 150	M12	IRD 15 PSOK-IBS
					npn, 200 mA, NO/NC			IRD 15 NSOK-IBS
					pnp, 200 mA, NO/NC		0.3m/M12	IRD 15 PSOK-K-BS
	20.1	D	<20	1.0	pnp, 200 mA, NO/NC	0.1 to 150	M12	IRD 20 PSOK-IBS
					npn, 200 mA, NO/NC			IRD 20 NSOK-IBS
					pnp, 200 mA, NO/NC		0.3m/M12	IRD 20 PSOK-K-BS
	25.1	D	<20	1.2	pnp, 200 mA, NO/NC	0.1 to 150	M12	IRD 25 PSOK-IBS
					npn, 200 mA, NO/NC			IRD 25 NSOK-IBS
					pnp, 200 mA, NO/NC		0.3m/M12	IRD 25 PSOK-K-BS
	35.2	D	<20	2.0	pnp, 200 mA, NO/NC	0.1 to 150	M12	IRD 35 PSOK-IBS
					npn, 200 mA, NO/NC			IRD 35 NSOK-IBS
	51.0	D	<20	2.5	pnp, 200 mA, NO/NC	0.1 to 150	M12	IRD 50 PSOK-IBS
					npn, 200 mA, NO/NC			IRD 50 NSOK-IBS
	101.0	D	<20	5.0	pnp, 200 mA, NO/NC	0.1 to 150	M12	IRD 100 PSOK-IBS
					npn, 200 mA, NO/NC			IRD 100 NSOK-IBS
	151.0	D	<20	10.0	pnp, 200 mA, NO/NC	0.1 to 150	M12	IRD 150 PSOK-IBS
					npn, 200 mA, NO/NC			IRD 150 NSOK-IBS

## IRDB WIRE BREAK SENSOR

The inductive wire breakage sensors in the IRDB series are used for detecting wire breaks. The sensors are available in the sizes Ø 4 mm and 6 mm. They can be put into service quickly and have no adjusting elements. These sensors work according to the static operating principle and exhibit a short response time.

Technical data (typ.)	+20 °C, 24 VDC
Service voltage	10 to 35 V DC
Sensitivity adjustment	Potentiometer
Voltage drop	2.0 V
Speed of parts	< 35 m/s
Ambient temperature	-25 to 70 °C
Protection type	IP 67
Insulation voltage endurance	1,000V
Housing material	Polyamide, ring POM ceramic insert (IRDBx 4...) Polyamide, ring POM (IRDBx 6...)



	Ring diameter (mm)	Evaluation: Static (S) / Dynamic (D)	No-load current (mA)	Resolution, Cu wire (mm)	Switching output	Pulse stretching (ms)	Cable length, Plug connector	Product description	
	4.0	T	11	0.2	pnp, 200 mA, NO npn, 200 mA, NO	10 to 150	M12	IRDB 4 PSOK-IBS IRDB 4 NSOK-IBS	
		D	<20	0.1	pnp, 200 mA, NO npn, 200 mA, NO	0.1 to 150		IRDBD 4 PSOK-IBS IRDBD 4 NSOK-IBS	
		T	11	0.2	pnp, 200 mA, NO npn, 200 mA, NO	10 to 150		M12	IRDB 6 PSOK-IBS IRDB 6 NSOK-IBS
		D	<20	0.1	pnp, 200 mA, NO npn, 200 mA, NO	0.1 to 150			IRDBD 6 PSOK-IBS IRDBD 6 NSOK-IBS

## IR-Z ACCESSORIES FOR INDUCTIVE RING SENSORS

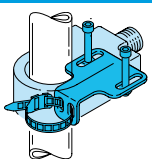
Mounting bracket for ring sensors IRB 6-27			
	Mounting diameter	Ø 4.5 mm	BW-IR01
	Mounting diameter	Ø 4.5 mm	BWS-IR01

## Inductive tube sensors

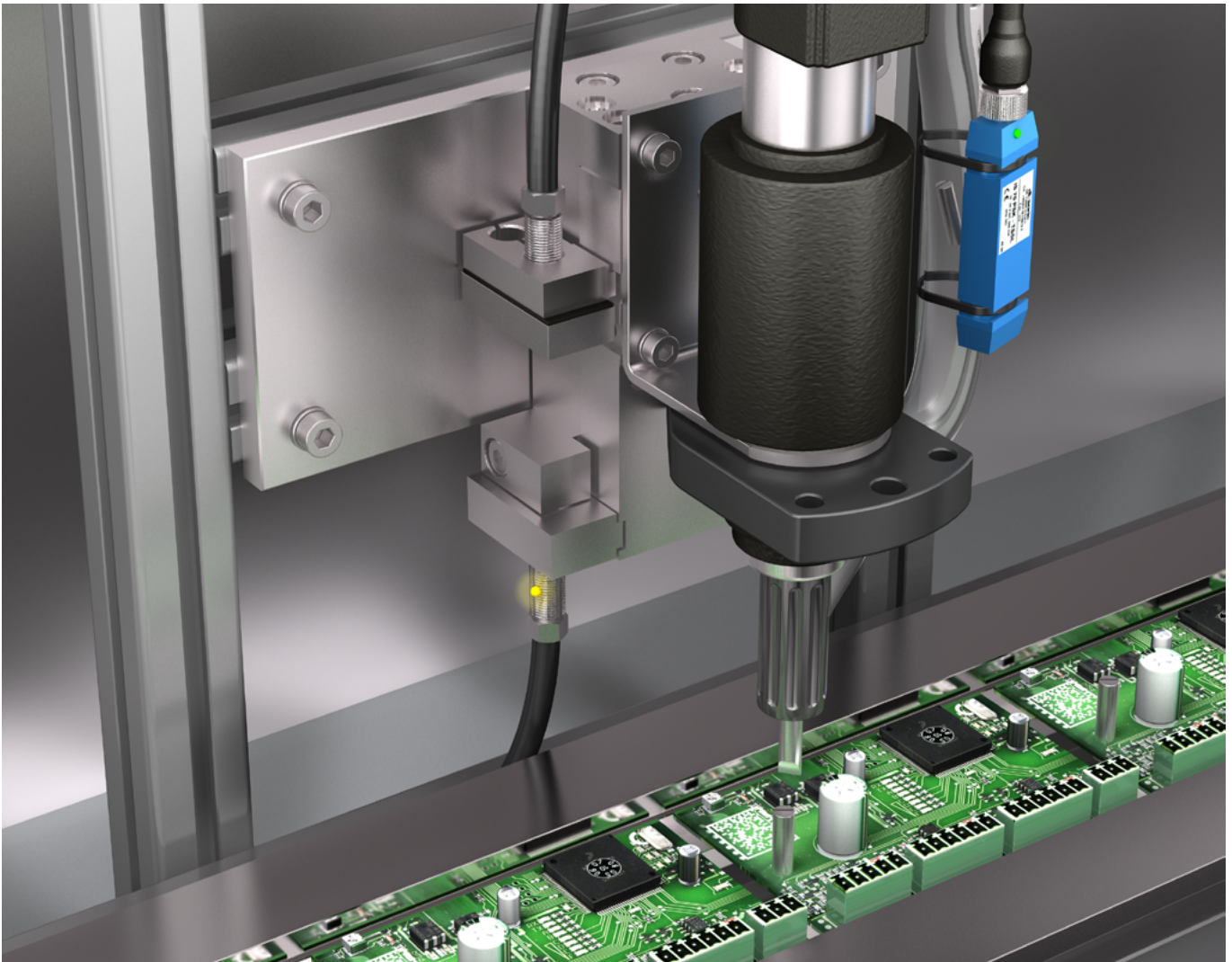

The area of application of our tube sensors is parts detection and counting. The static and dynamic evaluation principle enables a simple accumulation monitoring to be implemented. The compact sensors with a universal fastening system can be quickly adapted to different tube cross-sections without having to dismantle the supply tube.



## IS STATIC

Our inductive tube sensors in static design can detect the smallest metallic parts reliably. They are very well suited for quickly supplied parts and for the detection of material accumulation. They are available in the size 70 x 20 x 12 mm.



Technical data (typ.)	+20 °C, 24 VDC
Service voltage	10 to 35 V DC
Voltage drop	2.0 V
Shock/vibration load	30 g <sub>n</sub> /10 to 55 Hz, 1 mm
Speed of parts	<35 m/s
Ambient temperature	-25 to 70 °C
Protection type	IP 67
Insulation voltage endurance	500 V
LED display	Switching output yellow, operation green
Housing material	Polycarbonate

	Housing design Size (mm)	Evaluation: Static (S) / Dynamic (D)	No-load current (mA)	Switching output	Pulse stretching (ms)	Cable length, Plug connector	Product description
<b>IS Static</b>							
	70 x 20 x 12	T	15	pnp, 200 mA, NO	100	M8	IS 70 PSK-TSSL
				npn, 200 mA, NO			IS 70 NSK-TSSL
				pnp, 200 mA, NO		0.5m/M12	IS 70 PSLK-K-BS
				npn, 200 mA, NO			IS 70 NSLK-K-BS

## ISDP DYNAMIC

Our tube sensors with dynamic evaluation have a high resolution and a short response time. Contaminants with metallic content are automatically hidden. The sensors can be assembled afterward and can be fixed with cable ties. They stand out thanks to their low weight, their compact design and the high protection class IP 67. They also have a metallic connecting plug.



Technical data (typ.)	+20 °C, 24 VDC
Service voltage	10 to 35 V DC
Voltage drop	2.0 V
Shock/vibration load	30 g <sub>n</sub> /10 to 55 Hz, 1 mm
Speed of parts	<35 m/s
Ambient temperature	-25 to 70 °C
Protection type	IP 67
Insulation voltage endurance	500 V
LED display	Switching output yellow, operation green
Housing material	Polycarbonate

	Housing design Size (mm)	Evaluation: Static (S) / Dynamic (D)	No-load current (mA)	Switching output	Pulse stretching (ms)	Cable length, Plug connector	Product description
<b>ISDP Dynamic</b>							
	70 x 20 x 12	D	25	pnp, 200 mA, NO	100	M8	ISDP 70 PSK-TSSL
				npn, 200 mA, NO			ISDP 70 NSK-TSSL
				pnp, 200 mA, NO		0.5m/M12	ISDP 70 PSLK-K-BS
				npn, 200 mA, NO			ISDP 70 NSLK-K-BS

## Light barriers and diffuse sensors

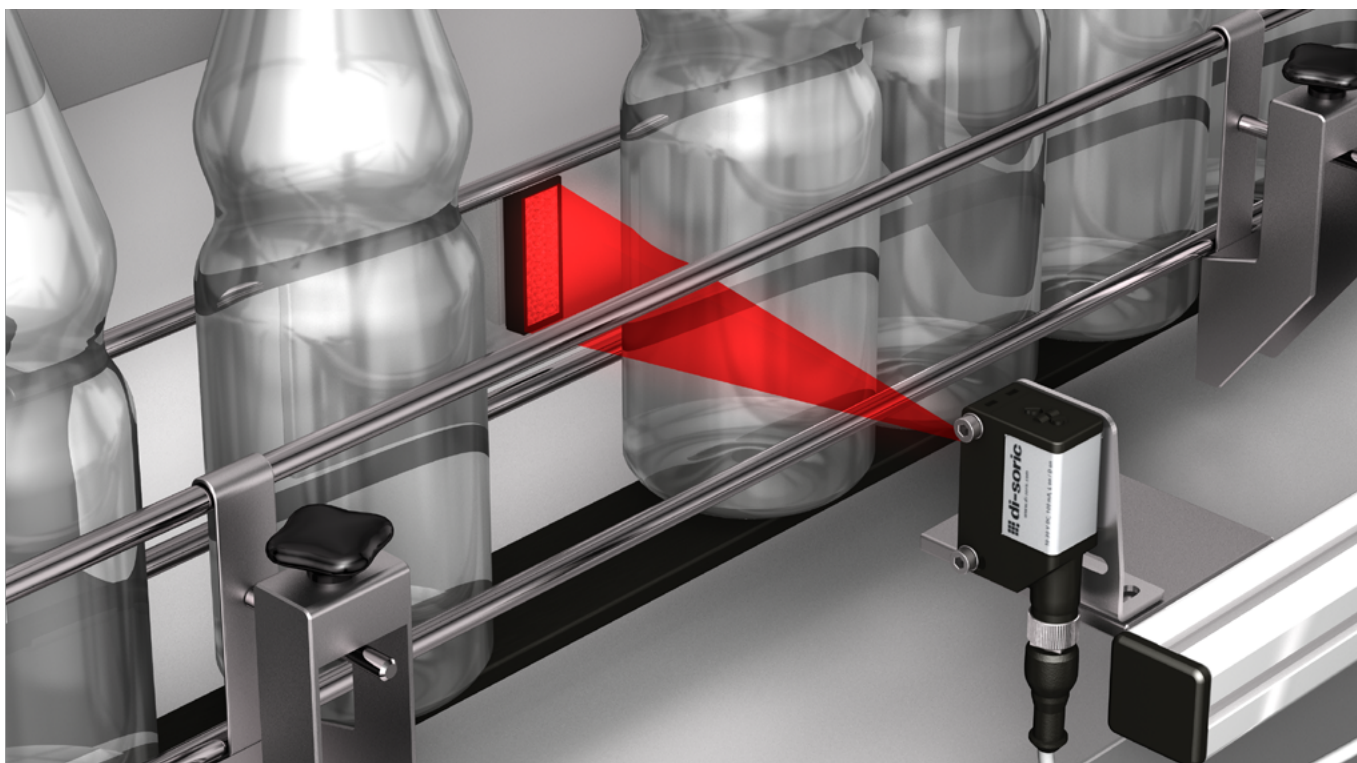

The light barriers and light sensors from di-soric have been developed in several models and functional principles for many task areas in automation technology. The products are suited for fast, secure object detection and are distinguished by the highest functional safety. Various operating principles, sensors, reflection or through-beam sensors are available.



 **di-soric**

O-20 Miniature	47
O-21 Miniature	48
O-30 Universal	50
O-40 Standard	52
O-40E Extended	52
O-50 Metal	53
O-81 Laser	54
O-Q10 Miniature	54
O-M5	55
O-M8	55
O-M18 Standard	56
O-M18E Extended	58
O-D4	58
O-Z-M Mechanical accessories for light barriers and light sensors	59



## O-20 MINIATURE

The very small, powerful light barriers and sensors in the O-20 series can be easily integrated. The devices, which are available as sensors, reflective or through-beam sensors, detect the smallest parts in the entire active zone.

<b>Technical data (typ.)</b>	<b>+20 °C, 24 VDC</b>
For more information, visit	<a href="http://www.di-soric.com">www.di-soric.com</a>



	Scan width / range, setting range (mm)	Housing design Size (mm)	Sensitivity setting by means of	Transmitter (T) / Receiver (R)	Transmission light (clocked)	Laser class	Switching output	Ambient temperature (°C)	Switching frequency (Hz)	Housing material	Cable material/length, Plug connector	Connection cable (optionally available)	Product description
<b>O-20 Miniature Reflection energetic light sensors</b>													
	20 to 50	22 x 13 x 8.5	Potentiometer	-	Laser, red	1	pnp, 50 mA NO/NC	-10 to +55	1,000	Plastic	2.0 m M8	- TK ... /4	LT 21 K 50 P3 LT 21 K 50 P3-K-T4
	20 to 70	22 x 13 x 8.5	Potentiometer	-	Laser, red	1	pnp, 50 mA NO/NC	-10 to +55	1,000	Plastic	2.0 m M8	- TK ... /4	LLT 21 K 70 P3 LLT 21 K 70 P3-K-T4
	45 to 300	22 x 13 x 8.5	Potentiometer	-	Laser, red	1	pnp, 50 mA NO/NC	-10 to +55	1,000	Plastic	2.0 m M8	- TK ... /4	LT 21 K 300 P3 LT 21 K 300 P3-K-T4
<b>O-20 Miniature Reflection light barriers</b>													
	0 to 4,000	22 x 13 x 8.5	Potentiometer	-	Laser, red	1	pnp, 50 mA NO/NC	-10 to +55	1,000	Plastic	2.0 m M8	- TK ... /4	LT 21 K 4000 P3 LT 21 K 4000 P3-K-T4
<b>O-20 Miniature through-beam barriers</b>													
	0 to 1,000	19 x 12 x 8.5	-	T/R	Laser, red	1	pnp, 50 mA NO/NC	-10 to +55	1,000	Plastic	2.0 m M8	- TK ... /4	LES 21 K 1000 P3 LES 21 K 1000 P3-K-T4

## O-21 MINIATURE

The very small and efficient light barriers and sensors in the O-21 miniature series with IO-Link can be easily integrated. The reflection sensors with background suppression are suited for detecting small and flat objects. The reflection sensors feature a high functional reserve.



Technical data (typ.)	+20 °C, 24 VDC
For more information, visit	www.di-soric.com

	Scan width / range, setting range (mm)	Housing design Size (mm)	Sensitivity setting by means of	Transmitter (T) / Receiver (R)	Transmission light (clocked)	Laser class	Switching output	Ambient temperature (°C)	Switching frequency (Hz)	Housing material	Cable material/length, Plug connector	Connection cable (optionally available)	Product description
<b>O-21 Miniature Reflection energetic light sensors</b>													
	0 to 180	28.1 x 8.1 x 14.4	IO-Link	-	Red		pnp, 100 mA NO	-25 to +60	1,000	Plastic	PVC, 2.0 m	-	OT21-PS-2C
			-				npn, 100 mA, NO						OT21-NS-2C
	0 to 180	28.1 x 8.1 x 14.4	IO-Link	-	Red		pnp, 100 mA NO	-25 to +60	1,000	Plastic	-	-	OT21-PS-0.3T3
			-				npn, 100 mA, NO						OT21-NS-0.3T3

	Scan width / range, setting range (mm)	Housing design Size (mm)	Sensitivity setting by means of	Transmitter (T) / Receiver (R)	Transmission light (clocked)	Laser class	Switching output	Ambient temperature (°C)	Switching frequency (Hz)	Housing material	Cable material/length, Plug connector	Connection cable (optionally available)	Product description
<b>O-21 Miniature Reflection light sensors background suppression</b>													
	15 (10 to 80)	28.1 x 8.1 x 14.4	IO-Link	-	Red		pnp, 100 mA NO/NC	-25 to +60	1,000	Plastic	PVC, 2.0 m	-	OH21-15PS-2C
			-				npn, 100 mA, NO						OH21-15NS-2C
	15 (10 to 80)	28.1 x 8.1 x 14.4	IO-Link	-	Red		pnp, 100 mA NO/NC	-25 to +60	1,000	Plastic	-	-	OH21-15PS-0.3-T3
			-				npn, 100 mA, NO						OH21-15NS-0.3T3
	50 (10 to 80)	28.1 x 8.1 x 14.4	IO-Link	-	Red		pnp, 100 mA NO/NC	-25 to +60	1,000	Plastic	PVC, 2.0 m	-	OH21-50PS-2C
			-				npn, 100 mA, NO						OH21-50NS-2C
	50 (10 to 80)	28.1 x 8.1 x 14.4	IO-Link	-	Red		pnp, 100 mA NO/NC	-25 to +60	1,000	Plastic	-	-	OH21-50PS-0.3T3
			-				npn, 100 mA, NO						OH21-50NS-0.3T3
	80 (10 to 80)	28.1 x 8.1 x 14.4	IO-Link	-	Red		pnp, 100 mA NO/NC	-25 to +60	1,000	Plastic	PVC, 2.0 m	-	OH21-80PS-2C
			-				npn, 100 mA, NO						OH21-80NS-2C
	80 (10 to 80)	28.1 x 8.1 x 14.4	IO-Link	-	Red		pnp, 100 mA NO/NC	-25 to +60	1,000	Plastic	-	-	OH21-80PS-0.3T3
			-				npn, 100 mA, NO						OH21-80NS-0.3T3

	Scan width / range, setting range (mm)	Housing design Size (mm)	Sensitivity setting by means of	Transmitter (T) / Receiver (R)	Transmission light (clocked)	Laser class	Switching output	Ambient temperature (°C)	Switching frequency (Hz)	Housing material	Cable material/length, Plug connector	Connection cable (optionally available)	Product description
<b>O-21 Miniature Reflection light barriers</b> 													
	20 to 1,800	28.1 x 8.1 x 14.4	IO-Link	-	Red		pnp, 100 mA NO	-25 to +60	1,000	Plastic	PVC, 2.0 m	-	OR21-PS-2C
			-				nnp, 100 mA, NO						OR21-NS-2C
	20 to 1,800	28.1 x 8.1 x 14.4	IO-Link	-	Red		pnp, 100 mA NO	-25 to +60	1,000	Plastic	-	-	OR21-PS-0.3T3
			-				nnp, 100 mA, NO						OR21-NS-0.3T3
<b>O-21 Miniature through-beam barriers</b> 													
	0 to 3,000	28.1 x 8.1 x 14.4	IO-Link	S	Red		pnp, 100 mA NO	-25 to +60	1,000	Plastic	PVC, 2.0	-	OS21-2C
			-				nnp, 100 mA, NO						OS21-0.3T3
	0 to 3,000	28.1 x 8.1 x 14.4	IO-Link	E	Red		pnp, 100 mA NO	-25 to +60	1,000	Plastic	PVC, 2.0 m	-	OE21-PS-2C
			-				nnp, 100 mA, NO						OE21-NS-2C
	0 to 3,000	28.1 x 8.1 x 14.4	IO-Link	E	Red		pnp, 100 mA NO	-25 to +60	1,000	Plastic	-	-	OE21-PS-0.3T3
			-				nnp, 100 mA, NO						OE21-NS-0.3T3

## O-30 UNIVERSAL

The efficient light barriers and sensors in the O-30 Universal series are versatile. With their compact design and mounting hole spacing of 25.4 mm, the sensors can be integrated quickly and easily. The user-friendly and robust devices with short response times and good functional reserves are suited for many applications in packaging technology and assembly and handling technology.

Technical data (typ.)	+20 °C, 24 VDC
For more information, visit	www.di-soric.com



	Scan width / range, setting range (mm)	Housing design Size (mm)	Sensitivity setting by means of	Transmitter (T) / Receiver (R)	Transmission light (clocked)	Laser class	Switching output	Ambient temperature (°C)	Switching frequency (Hz)	Housing material	Cable material/length, Plug connector	Connection cable (optionally available)	Product description
<b>O-30 Miniature Reflection energetic light sensors</b>													
	10 to 100	31 x 21 x 13	Potentiometer	–	Red		pnp, 100 mA NO/NC	-25 to +70	1,000	Plastic	M8 TK ... /4		OT 31 K 100 P3-T4
											0.2 m/M8 TK ...		OT 31 K 100 P3-K-T3
											2.0 m –		OT 31 K 100 P3-3
	10 to 100	31 x 21 x 13	Potentiometer	–	Red		npn, 100 mA NO/NC	-25 to +70	1,000	Plastic	M8 TK ... /4		OT 31 K 100 N3-T4
											0.2 m/M8 TK ...		OT 31 K 100 N3-K-T3
											2.0 m –		OT 31 K 100 N3-3
	0 to 400	31 x 21 x 13	Potentiometer	–	Red		pnp, 100 mA NO/NC	-25 to +70	2,000	Plastic	M8 TK ... /4		OT 31 K 400 P3-T4
											0.2 m/M8 TK ...		OT 31 K 400 P3-K-T3
											2.0 m –		OT 31 K 400 P3-3
	0 to 400	31 x 21 x 13	Potentiometer	–	Red		npn, 100 mA NO/NC	-25 to +70	2,000	Plastic	M8 TK ... /4		OT 31 K 400 N3-T4
											0.2 m/M8 TK ...		OT 31 K 400 N3-K-T3
											2.0 m –		OT 31 K 400 N3-3
	0 to 1,000	31 x 21 x 13	Potentiometer	–	Red		pnp, 100 mA NO/NC	-25 to +70	1,000	Plastic	M8 TK ... /4		OT 31 K 1000 P3-T4
											0.2 m/M8 TK ...		OT 31 K 1000 P3-K-T3
											2.0 m –		OT 31 K 1000 P3-3
	0 to 1,000	31 x 21 x 13	Potentiometer	–	Red		npn, 100 mA NO/NC	-25 to +70	1,000	Plastic	M8 TK ... /4		OT 31 K 1000 N3-T4
											0.2 m/M8 TK ...		OT 31 K 1000 N3-K-T3
											2.0 m –		OT 31 K 1000 N3-3

	Scan width / range, setting range (mm)	Housing design Size (mm)	Sensitivity setting by means of	Transmitter (T) / Receiver (R)	Transmission light (clocked)	Laser class	Switching output	Ambient temperature (°C)	Switching frequency (Hz)	Housing material	Cable material/length, Plug connector	Connection cable (optionally available)	Product description
<b>O-30 Miniature Reflection light sensors background suppression</b>													
	30 to 200	31 x 21 x 13	Potentiometer	–	Red		pnp, 100 mA NO/NC	-25 to +70	1,000	Plastic	M8 TK ... /4		OH 31 K 200 P3-T4
											0.2 m/M8 TK ...		OH 31 K 200 P3-K-T3
											2.0 m –		OH 31 K 200 P3-3
	30 to 200	31 x 21 x 13	Potentiometer	–	Red		npn, 100 mA NO/NC	-25 to +70	1,000	Plastic	M8 TK ... /4		OH 31 K 200 N3-T4
											0.2 m/M8 TK ...		OH 31 K 200 N3-K-T3
											2.0 m –		OH 31 K 200 N3-3
	30 to 400	31 x 21 x 13	Potentiometer	–	Infrared		pnp, 100 mA NO/NC	-25 to +70	1,000	Plastic	M8 TK ... /4		OH 30 K 400 P3-T4
											0.2 m/M8 TK ...		OH 30 K 400 P3-K-T3
											2.0 m –		OH 30 K 400 P3-3
	30 to 400	31 x 21 x 13	Potentiometer	–	Infrared		npn, 100 mA NO/NC	-25 to +70	1,000	Plastic	M8 TK ... /4		OH 30 K 400 N3-T4
											0.2 m/M8 TK ...		OH 30 K 400 N3-K-T3
											2.0 m –		OH 30 K 400 N3-3

Scan width / range, setting range (mm)	Housing design Size (mm)	Sensitivity setting by means of	Transmitter (T)/Receiver (R)	Transmission light (clocked)	Laser class	Switching output	Ambient temperature (°C)	Switching frequency (Hz)	Housing material	Cable material/length, Plug connector	Connection cable (optionally available)	Product description
--	--------------------------	---------------------------------	------------------------------	------------------------------	-------------	------------------	--------------------------	--------------------------	------------------	---------------------------------------	---	---------------------

O-30 Miniature Reflection light barriers 													
	50 to 1,500	31 x 21 x 13	Potentiometer	-	Red		pnp, 100 mA NO/NC	-25 to +70	2,000	Plastic	M8	TK ... /4	OR 31 K 1500 P3-T4
											0.2m/M8	TK ...	OR 31 K 1500 P3-K-T3
											2.0m	-	OR 31 K 1500 P3-3
	50 to 1,500	31 x 21 x 13	Potentiometer	-	Red		nnp, 100 mA NO/NC	-25 to +70	2,000	Plastic	M8	TK ... /4	OR 31 K 1500 N3-T4
											0.2m/M8	TK ...	OR 31 K 1500 N3-K-T3
											2.0m	-	OR 31 K 1500 N3-3
	400 to 4,000	31 x 21 x 13	Potentiometer	-	Red		pnp, 100 mA NO/NC	-25 to +70	2,000	Plastic	M8	TK ... /4	OR 31 K 4000 P3-T4
											0.2m/M8	TK ...	OR 31 K 4000 P3-K-T3
											2.0m	-	OR 31 K 4000 P3-3
	400 to 4,000	31 x 21 x 13	Potentiometer	-	Red		nnp, 100 mA NO/NC	-25 to +70	2,000	Plastic	M8	TK ... /4	OR 31 K 4000 N3-T4
											0.2m/M8	TK ...	OR 31 K 4000 N3-K-T3
											2.0m	-	OR 31 K 4000 N3-3

O-30 Universal Reflection light barriers 													
	0 to 20,000	31 x 21 x 13	Potentiometer	-	Red		pnp, 100 mA NO/NC	-25 to +70	2,000	Plastic	M8	TK ... /4	OES 31 K 20000 P3-T4
											0.2m/M8	TK ...	OES 31 K 20000 P3-K-T3
											2.0m	-	OES 31 K 20000 P3-3
	0 to 20,000	31 x 21 x 13	Potentiometer	-	Red		nnp, 100 mA NO/NC	-25 to +70	2,000	Plastic	M8	TK ... /4	OES 31 K 20000 N3-T4
											0.2m/M8	TK ...	OES 31 K 20000 N3-K-T3
											2.0m	-	OES 31 K 20000 N3-3

## O-40 STANDARD

The compact light barriers and sensors in the O-40 Standard series are suited for medium ranges in a broad field of application. The sensors are reliable, economic and cost-efficient. The universal slotted-hole fastening makes flexible mounting possible.



Technical data (typ.)	+20 °C, 24 VDC
For more information, visit	www.di-soric.com

	Scan width / range, setting range (mm)	Housing design Size (mm)	Sensitivity setting by means of	Transmitter (T) / Receiver (R)	Transmission light (clocked)	Laser class	Switching output	Ambient temperature (°C)	Switching frequency (Hz)	Housing material	Cable material/length, Plug connector	Connection cable (optionally available)	Product description
<b>O-40 Standard Reflection energetic light sensors</b>													
	10 to 600	38 x 27 x 15	Potentiometer	-	Red		pnp, 100 mA NO pnp, 100 mA NC	-25 to +60	500	Plastic	M8	TK ...	OT 6-41 K 0.6 P1-T3 OT 6-41 K 0.6 P2-T3
	100 to 1,000	41 x 31.5 x 16	Teach	-	Red		Push-pull, 200 mA NO/NC	-25 to +60	1,000	Metal	M8	TK ...	OTT 41 M 1 G3-T3
<b>O-40 Standard Reflection light barriers</b>													
	400 to 4,000	38 x 27 x 15	Potentiometer	-	Red		pnp, 100 mA NC pnp, 100 mA NO	-25 to +60	500	Plastic	M8	TK ...	OR 6-41 K 4 P1-T3 OR 6-41 K 4 P2-T3

## O-40E EXTENDED

The devices in the O-40E Extended series for medium ranges have a robust metallic housing with a metallic plug and are used in the detection of standard or small parts. These light barriers detect with LED or with laser variants (laser class 1) that are safe for the eye.



Technical data (typ.)	+20 °C, 24 VDC
For more information, visit	www.di-soric.com

	Scan width / range, setting range (mm)	Housing design Size (mm)	Sensitivity setting by means of	Transmitter (T) / Receiver (R)	Transmission light (clocked)	Laser class	Switching output	Ambient temperature (°C)	Switching frequency (Hz)	Housing material	Cable material/length, Plug connector	Connection cable (optionally available)	Product description
<b>O-40E Extended Reflection light sensors background suppression</b>													
	30 to 350	40 x 30 x 15	Potentiometer	-		1	Push-pull, 200 mA NO/NC antivalent	-10 to +50	1,000	Metal	M8	TK ... /4	LH 41 M 350 G4L-T4

## O-50 METAL

The robust and highly efficient light barriers in the O-50 Metal series work with visible red light LEDs or with laser light that is safe for the eye (laser class 1). They are robust and have a metallic housing and metallic plug. The sensors have maximum functional reserve and are used for long ranges.



### Technical data (typ.) +20 °C, 24 VDC

For more information, visit [www.di-soric.com](http://www.di-soric.com)

	Scan width / range, setting range (mm)	Housing design Size (mm)	Sensitivity setting by means of	Transmitter (T) / Receiver (R)	Transmission light (clocked)	Laser class	Switching output	Ambient temperature (°C)	Switching frequency (Hz)	Housing material	Cable material/length, Plug connector	Connection cable (optionally available)	Product description
<b>O-50 Metal Reflection energetic light sensors</b>													
	15 to 150	50 x 40 x 15	Potentiometer	–	Red		pnp, 200 mA NO/NC	-10 to +60	1,000	Metal	M12	VK ...	OTV 51 M 150 P3K-IBS
	100 to 500												OTV 51 M 500 P3K-IBS
	100 to 600	50 x 40 x 15	Potentiometer	–	Infrared		pnp, 200 mA NO/NC	-10 to +60	1,000	Metal	M12	VK ...	OTV 50 M 600 P3K-IBS
	50 to 1,200												OTV 50 M 1200 P3K-IBS
	75 to 200	50 x 40 x 15	Potentiometer	–		1	pnp, 200 mA NO/NC	-10 to +50	2,000	Metal	M12	VK ...	LTV 51 M 200 P3K-IBS
	100 to 600								500				LTV 51 M 600 P3K-IBS
<b>O-50 Metal Reflection light sensors background suppression</b>													
	50 to 200	50 x 40 x 15	Potentiometer	–		1	Push-pull, 200 mA NO/NC	-10 to +50	500	Metal	M12	VK ...	LHT 51 M 200 G3-B41)
	50 to 200	50 x 40 x 15	Potentiometer	–		1	Push-pull, 200 mA NO/NC	-10 to +50	500	Metal	M12	VK ...	LLH 51 M 200 G3-B4
<b>O-50 Metal Reflection light barriers</b>													
	40 to 2,000	50 x 40 x 15	Potentiometer	–	Red		pnp, 200 mA NO/NC	-10 to +60	1,000	Metal	M12	VK ...	ORV 51 M 2000 P3K-IBS
	300 to 5,000	50 x 40 x 15	Potentiometer	–	Red		pnp, 200 mA NO/NC	-10 to +60	1,000	Metal	M12	VK ...	ORV 51 M 5000 P3K-IBS
	100 to 1,000												LRV 51 M 1000 P3K-IBS
	200 to 2,000	50 x 40 x 15	Potentiometer	–		1	pnp, 200 mA NO/NC	0 to +50	2,000	Metal	M12	VK ...	LRV 51 M 2000 P3K-IBS
	1,000 to 10,000												LRV 51 M 10000 P3K-IBS
	50 to 500	50 x 40 x 15	Potentiometer	–		1	pnp, 200 mA NO/NC	5 to +50	750	Metal	M12	VK ...	LLRV 51 M 500 P3K-IBS
<b>O-50 Metal Reflection light barriers</b>													
	0 to 10,000	50 x 40 x 15	Potentiometer	T	Red		–	-25 to +60		Metal	M12	VK ...	OSV 51 M 10000-IBS
				E	Red		pnp, 200 mA NO/NC	-25 to +60	100/200	Metal	M12	VK ...	OEV 51 M 10000-P3K-IBS

## O-81 LASER

The laser light sensors in the O-81 Laser series are used for precise detection of objects using red light lasers. The sensors can be adjusted precisely and distinguished by their high resolution and functional reserve. The robust devices with a metallic housing and metallic plug can be operated intuitively by way of potentiometers and NO-NC switches.



<b>Technical data (typ.)</b>	<b>+20 °C, 24 VDC</b>
For more information, visit	<a href="http://www.di-soric.com">www.di-soric.com</a>

	Scan width / range, setting range (mm)	Housing design Size (mm)	Sensitivity setting by means of	Transmitter (T) / Receiver (R)	Transmission light (clocked)	Laser class	Switching output	Ambient temperature (°C)	Switching frequency (Hz)	Housing material	Cable material/length, Plug connector	Connection cable (optionally available)	Product description
<b>O-81 Metal Reflection light sensors background suppression</b>													
	40 to 400	76 x 30 x 18	Potentiometer	-		1	Antivalent, 200 mA NO/NC	-10 to +60	1,000	Metal	M12	VK ... /4	LHT 81 M 300 G4L-IBS
							200 mA, NO switching output NC alarm output						LHT 81 M 300 G6L-IBS
	40 to 400	76 x 30 x 18	Potentiometer	-		1	Antivalent, 200 mA NO/NC	-20 to +60	1,000	Metal	M12	VK ... /4	LHT 81 M 400 G4L-IBS
							200 mA, NO switching output NC alarm output						LHT 81 M 400 G6L-IBS

## O-Q10 MINIATURE

The devices in O-Q10 Miniature series are the first choice for applications that require compact laser through-beam barriers for small parts detection. The robust devices with a metallic housing and metallic plug consistently satisfy the safe laser protection class 1.



<b>Technical data (typ.)</b>	<b>+20 °C, 24 VDC</b>
For more information, visit	<a href="http://www.di-soric.com">www.di-soric.com</a>

	Scan width / range, setting range (mm)	Housing design Size (mm)	Sensitivity setting by means of	Transmitter (T) / Receiver (R)	Transmission light (clocked)	Laser class	Switching output	Ambient temperature (°C)	Switching frequency (Hz)	Housing material	Cable material/length, Plug connector	Connection cable (optionally available)	Product description
<b>O-Q10 Miniature through-beam barriers</b>													
	0 to 500	10 x 10 x 60	-	T		1	-	0 to +50	2,000	Metal	M8	TK ...	OLSQ 10 M 500-TSSL
							pnp, 200 mA NC						OLEQ 10 M 500 P1K-TSSL
							pnp, 200 mA NO						OLEQ 10 M 500 P2K-TSSL
	0 to 2,000	10 x 10 x 60	-	T		1	-	0 to +50	2,000	Metal	M8	TK ...	OLSQ 10 M 2000-TSSL
							pnp, 200 mA NC						OLEQ 10 M 2000 P1K-TSSL
							pnp, 200 mA NO						OLEQ 10 M 2000 P2K-TSSL



## O-M5

The devices in the O-M5 series are the smallest diffuse sensors from di-soric in a threaded model. The sensors are distinguished by their precise detection of objects and are ideal for mounting in confined space conditions.

Technical data (typ.)	+20 °C, 24 VDC
For more information, visit	<a href="http://www.di-soric.com">www.di-soric.com</a>



	Scan width / range, setting range (mm)	Housing design Size (mm)	Sensitivity setting by means of	Transmitter (T) / Receiver (R)	Transmission light (clocked)	Laser class	Switching output	Ambient temperature (°C)	Switching frequency (Hz)	Housing material	Cable material/length, Plug connector	Connection cable (optionally available)	Product description
	... 10	M5	-	-	Red light		pnp, 100mA NO	-25 to +65	1000	Stainless steel V2A	2.0 m	-	OTM05-10PS-2R
											M8	TK ...	OTM05-10PS-T3
	... 20	M5	-	-	Red light		pnp, 100mA NO	-25 to +65	1000	Stainless steel V2A	2.0 m	-	OTM05-20PS-2R
											M8	TK ...	OTM05-20PS-T3
	... 50	M5	-	-	Red light		pnp, 100mA NO	-25 to +65	1000	Stainless steel V2A	2.0 m	-	OTM05-50PS-2R
											M8	TK ...	OTM05-50PS-T3

## O-M8

The compact laser light sensors are used for the detection of small parts and are designed for the safe laser class 1. This avoids injuries to the human eye.

Technical data (typ.)	+20 °C, 24 VDC
For more information, visit	<a href="http://www.di-soric.com">www.di-soric.com</a>



	Scan width / range, setting range (mm)	Housing design Size (mm)	Sensitivity setting by means of	Transmitter (T) / Receiver (R)	Transmission light (clocked)	Laser class	Switching output	Ambient temperature (°C)	Switching frequency (Hz)	Housing material	Cable material/length, Plug connector	Connection cable (optionally available)	Product description
	0 to 2,000	M8 x 70	-	T		1	-	0 to +50	2,000	Stainless steel	M8	TK ...	OLS 08 V 2000-TSSL
				E									pnp, 200mA NO

## O-M18 STANDARD

The light barriers and light sensors in the O-M18 Standard series are ideal devices for economical and cost-efficient applications. The sensors are alternatively available in a straight model or with 90° angled optics. The plastic or metallic housing is distinguished by its short construction.



<b>Technical data (typ.)</b>	<b>+20 °C, 24 VDC</b>
For more information, visit	<a href="http://www.di-soric.com">www.di-soric.com</a>

Scan width / range, setting range (mm)	Housing design Size (mm)	Sensitivity setting by means of	Transmitter (T) / Receiver (R)	Transmission light (clocked)	Laser class	Switching output	Ambient temperature (°C)	Switching frequency (Hz)	Housing material	Cable material/length, Plug connector	Connection cable (optionally available)	Product description
--	--------------------------	---------------------------------	--------------------------------	------------------------------	-------------	------------------	--------------------------	--------------------------	------------------	---------------------------------------	---	---------------------

O-M18 Standard Diffuse reflective sensors													
	320	M18 x 68	Potentiometer	-	Infrared		pnp, 100 mA NO/NC	-25 to +55	1,000	Plastic	M12	VK... /4	OT 18 FKR 320 P3-B4
										Metal			OT 18 FMR 320 P3-B4
	320	M18 x 68	Potentiometer	-	Infrared		nnp, 100 mA NO/NC	-25 to +55	1,000	Plastic	M12	VK... /4	OT 18 FKR 320 N3-B4
										Metal			OT 18 FMR 320 N3-B4
	320	M18 x 58	Potentiometer	-	Infrared		pnp, 100 mA NO/NC	-25 to +55	1,000	Plastic	PVC, 2.0 m	-	OT 18 FKR 320 P3
										Metal			OT 18 FMR 320 P3
	320	M18 x 58	Potentiometer	-	Infrared		nnp, 100 mA NO/NC	-25 to +55	1,000	Plastic	PVC, 2.0 m	-	OT 18 FKR 320 N3
										Metal			OT 18 FMR 320 N3
	400	M18 x 55	Potentiometer	-	Infrared		pnp, 100 mA NO/NC	-25 to +55	1,000	Plastic	M12	VK... /4	OT 18 FK 400 P3-B4
										Metal			OT 18 FM 400 P3-B4
	400	M18 x 55	Potentiometer	-	Infrared		nnp, 100 mA NO/NC	-25 to +55	1,000	Plastic	M12	VK... /4	OT 18 FK 400 N3-B4
										Metal			OT 18 FM 400 N3-B4
	400	M18 x 45	Potentiometer	-	Infrared		pnp, 100 mA NO/NC	-25 to +55	1,000	Plastic	PVC, 2.0 m	-	OT 18 FK 400 P3
										Metal			OT 18 FM 400 P3
	400	M18 x 45	Potentiometer	-	Infrared		nnp, 100 mA NO/NC	-25 to +55	1,000	Plastic	PVC, 2.0 m	-	OT 18 FK 400 N3
										Metal			OT 18 FM 400 N3

O-M18 Standard Retroreflective sensors													
	3,000	M18 x 83	Potentiometer	-	Red		pnp, 100 mA NO/NC	-25 to +70	250	Metal	M12	VK... /4	OR 18-1 M 3000 P4-B4
							nnp, 100 mA NO/NC						
	3,600	M18 x 68	Potentiometer	-	Red		pnp, 100 mA NO/NC	-25 to +55	1,000	Plastic	M12	VK... /4	OR 18-1 FKR 3600 P3-B4
										Metal			
	3,600	M18 x 68	Potentiometer	-	Red		nnp, 100 mA NO/NC	-25 to +55	1,000	Plastic	M12	VK... /4	OR 18-1 FKR 3600 N3-B4
										Metal			
	3,600	M18 x 58	Potentiometer	-	Red		pnp, 100 mA NO/NC	-25 to +55	1,000	Plastic	PVC, 2.0 m	-	OR 18-1 FKR 3600 P3
										Metal			OR 18-1 FMR 3600 P3
	3,600	M18 x 58	Potentiometer	-	Red		nnp, 100 mA NO/NC	-25 to +55	1,000	Plastic	PVC, 2.0 m	-	OR 18-1 FKR 3600 N3
										Metal			OR 18-1 FMR 3600 N3
	5,700	M18 x 55	Potentiometer	-	Red		pnp, 100 mA NO/NC	-25 to +55	1,000	Plastic	M12	VK... /4	OR 18-1 FK 5700 P3-B4
										Metal			
	5,700	M18 x 55	Potentiometer	-	Red		nnp, 100 mA NO/NC	-25 to +55	1,000	Plastic	M12	VK... /4	OR 18-1 FK 5700 N3-B4
										Metal			

	Scan width / range, setting range (mm)	Housing design Size (mm)	Sensitivity setting by means of	Transmitter (T) / Receiver (R)	Transmission light (clocked)	Laser class	Switching output	Ambient temperature (°C)	Switching frequency (Hz)	Housing material	Cable material/length, Plug connector	Connection cable (optionally available)	Product description
<b>O-M18 Standard Retroreflective sensors</b>													
	5,700	M18 x 45	Potentiometer	-	Red		pnp, 100 mA NO/NC	-25 to +55	1,000	Plastic Metal	PVC, 2.0 m	-	OR 18-1 FK 5700 P3 OR 18-1 FM 5700 P3
	5,700	M18 x 45	Potentiometer	-	Red		npn, 100 mA NO/NC	-25 to +55	1,000	Plastic Metal	PVC, 2.0 m	-	OR 18-1 FK 5700 N3 OR 18-1 FM 5700 N3
<b>O-M18 Standard Diffuse reflective sensors</b>													
	600	M18 x 68	Potentiometer	-	Infrared		pnp, 100 mA NO/NC	-25 to +55	1,000	Plastic Metal	M12	VK... /4	OT 18 FKR 600 P3-B4 OT 18 FMR 600 P3-B4
	600	M18 x 68	Potentiometer	-	Infrared		npn, 100 mA NO/NC	-25 to +55	1,000	Plastic Metal	M12	VK... /4	OT 18 FKR 600 N3-B4 OT 18 FMR 600 N3-B4
	600	M18 x 58	Potentiometer	-	Infrared		pnp, 100 mA NO/NC	-25 to +55	1,000	Plastic Metal	PVC, 2.0 m	-	OT 18 FKR 600 P3 OT 18 FMR 600 P3
	600	M18 x 58	Potentiometer	-	Infrared		npn, 100 mA NO/NC	-25 to +55	1,000	Plastic Metal	PVC, 2.0 m	-	OT 18 FKR 600 N3 OT 18 FMR 600 N3
	800	M18 x 55	Potentiometer	-	Infrared		pnp, 100 mA NO/NC	-25 to +55	1,000	Plastic Metal	M12	VK... /4	OT 18 FK 800 P3-B4 OT 18 FM 800 P3-B4
	800	M18 x 55	Potentiometer	-	Infrared		npn, 100 mA NO/NC	-25 to +55	1,000	Plastic Metal	M12	VK... /4	OT 18 FK 800 N3-B4 OT 18 FM 800 N3-B4
	800	M18 x 45	Potentiometer	-	Infrared		pnp, 100 mA NO/NC	-25 to +55	1,000	Plastic Metal	PVC, 2.0 m	-	OT 18 FK 800 P3 OT 18 FM 800 P3
	800	M18 x 45	Potentiometer	-	Infrared		npn, 100 mA NO/NC	-25 to +55	1,000	Plastic Metal	PVC, 2.0 m	-	OT 18 FK 800 N3 OT 18 FM 800 N3
<b>O-M18 Miniature Through-beam sensors</b>													
	8,000	M18 x 68	Potentiometer	-	Infrared		pnp, 100 mA NO/NC	-25 to +55	1,000	Plastic Metal	M12	VK... /4	OES 18 FKR 8000 P3-B4 OES 18 FMR 8000 P3-B4
	8,000	M18 x 68	Potentiometer	-	Infrared		npn, 100 mA NO/NC	-25 to +55	1,000	Plastic Metal	M12	VK... /4	OES 18 FKR 8000 N3-B4 OES 18 FMR 8000 N3-B4
	8,000	M18 x 58	Potentiometer	-	Infrared		pnp, 100 mA NO/NC	-25 to +55	1,000	Plastic Metal	PVC, 2.0 m	-	OES 18 FKR 8000 P3 OES 18 FMR 8000 P3
	8,000	M18 x 58	Potentiometer	-	Infrared		npn, 100 mA NO/NC	-25 to +55	1,000	Plastic Metal	PVC, 2.0 m	-	OES 18 FKR 8000 N3 OES 18 FMR 8000 N3
	10,000	M18 x 55	Potentiometer	-	Infrared		pnp, 100 mA NO/NC	-25 to +55	333	Plastic Metal	M12	VK... /4	OES 18 FK 10000 P3-B4 OES 18 FM 10000 P3-B4
	10,000	M18 x 55	Potentiometer	-	Infrared		npn, 100 mA NO/NC	-25 to +55	333	Plastic Metal	M12	VK... /4	OES 18 FK 10000 N3-B4 OES 18 FM 10000 N3-B4
	10,000	M18 x 45	Potentiometer	-	Infrared		pnp, 100 mA NO/NC	-25 to +55	333	Plastic Metal	PVC, 2.0 m	-	OES 18 FK 10000 P3 OES 18 FM 10000 P3
	10,000	M18 x 45	Potentiometer	-	Infrared		npn, 100 mA NO/NC	-25 to +55	333	Plastic Metal	PVC, 2.0 m	-	OES 18 FK 10000 N3 OES 18 FM 10000 N3

## O-M18E EXTENDED

The light sensors in the O-M18E Extended series can be used universally and are the first choice in challenging applications. The devices have a robust metallic housing and score points with their high functional reserve and efficient background suppression.

<b>Technical data (typ.)</b>	<b>+20 °C, 24 VDC</b>
For more information, visit	<a href="http://www.di-soric.com">www.di-soric.com</a>



Scan width / range, setting range (mm)	Housing design Size (mm)	Sensitivity setting by means of	Transmitter (T) / Receiver (R)	Transmission light (clocked)	Laser class	Switching output	Ambient temperature (°C)	Switching frequency (Hz)	Housing material	Cable material/length, Plug connector	Connection cable (optionally available)	Product description
<b>O-M18E Extended</b> Reflection light sensors background suppression												
	30 to 130	M18 x 80	Potentiometer	-	Red	pnp, 100 mA NO/NC	-25 to +70	1,000	Metal	M12	VK... /4	OH 18-1 M 130 P4-B4
						nnp, 100 mA NO/NC						OH 18-1 M 130 N4-B4

## O-D4

The devices in the O-D4 series are the smallest light sensors that di-soric offers in a cylindrical model. They guarantee the precise detection of objects and are ideal for mounting anywhere space is scarce.















<b>Technical data (typ.)</b>	<b>+20 °C, 24 VDC</b>
For more information, visit	<a href="http://www.di-soric.com">www.di-soric.com</a>



Scan width / range, setting range (mm)	Housing design Size (mm)	Sensitivity setting by means of	Transmitter (T) / Receiver (R)	Transmission light (clocked)	Laser class	Switching output	Ambient temperature (°C)	Switching frequency (Hz)	Housing material	Cable material/length, Plug connector	Connection cable (optionally available)	Product description
<b>O-D4</b> Reflection energetic light sensors												
	... 10	Ø4.0	-	-	Red light	pnp, 100 mA NO	-25 to +65	1000	Stainless steel V2A	2.0 m	-	OTD04-10PS-2R
										M8	TK ...	OTD04-10PS-T3
	... 20	Ø4.0	-	-	Red light	pnp, 100 mA NO	-25 to +65	1000	Stainless steel V2A	2.0 m	-	OTD04-20PS-2R
										M8	TK ...	OTD04-20PS-T3
	... 50	Ø4.0	-	-	Red light	pnp, 100 mA NO	-25 to +65	1000	Stainless steel V2A	2.0 m	-	OTD04-50PS-2R
										M8	TK ...	OTD04-50PS-T3

## O-Z-M MECHANICAL ACCESSORIES FOR LIGHT BARRIERS AND LIGHT SENSORS

Specific fastening angles, sensor brackets and wobble plates make adjustment and assembly of optical sensors easy.

To be used for		Product description
<b>Fastening angles for light barriers and light sensors</b>		
 	O-20 Miniature	BW 22/22
		BW 30
   	O-30 Universal	BW 31-36
		BW 31-39
		BW 31-41
		BW 31-56
 	O-40E Extended	BW 41
		BW 41-80
	O-50 Metal	BW 50
 	O-81 Laser	BW LHT 81
		SHB-LHT-81
<b>Sensor brackets for light barriers and light sensors</b>		
	O-20 Miniature	SH-S20
	O-40	SH-S41-SN
<b>Wobble plates for light barriers and light sensors</b>		
	O-Q10 O-Q15	TP-Q
	O-Q10 O-Q15	TP-Q90

## Optical distance sensors

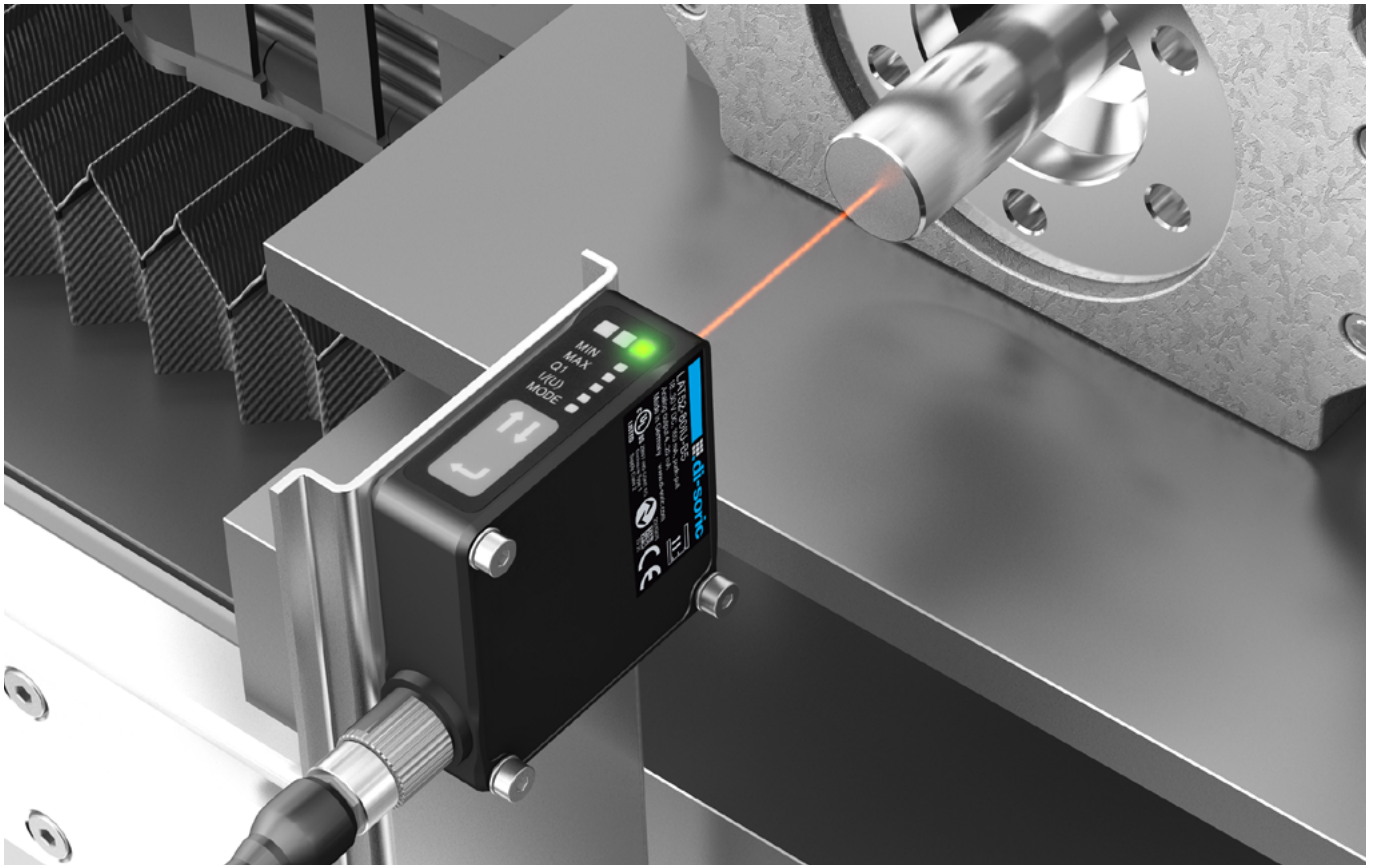

The optical distance sensors measure distances quickly and precisely with red light laser. Thanks to the metallic housing, all sensors are very robust. They offer a wide bandwidth of measuring ranges and ranges of up to 10 m, and resolutions into the micrometer range.



 **di-soric**



LAT-45 Long range	61
LAT-52 Compact	62
LVHT-52 Compact	63
LAT-61 Precise	64
LAT-Z Accessories for optical distance sensors	65

## LAT-45 LONG RANGE

The LAT-45 features a long range of up to 10m. The sensor is equally well suited for measuring and switching applications. The LAT-45 is operated alternatively via keypad or IO-Link, its easily legible display is used to display measured values. A good color and surface independence makes distance measurement possible on many surfaces.



Technical data (typ.)	+20 °C, 24 VDC	
Emitted light	Red-light laser, 650nm	
Switching output 1	pnp, 200mA, NO/NC switchable	
Switching output 2	pnp or analog output	
Switching output 3	-	
Analog output	4 to 20 mA 0 to 10 V	
Measuring frequency	1 to 33 Hz	
No-load current	< 150mA	
Interface	IO-Link V1.1, COM2	
Ambient temperature	-10 to +60 °C	
Protection type	IP 67	
Housing material	Die-cast zinc, black varnished	

	Laser distance sensors	Laser diffuse sensors with background suppression	Analog output (4 to 20 mA)	Analog output (0 to 10 V)	Detection range (mm)	Housing design Size (mm)	Digital display	Service voltage (VDC)	Resolution (mm)	Measuring frequency (Hz)	Switching frequency (Hz)	Laser class	Cable material/length, Plug connector	Connection cable (optionally available)	Product description
<b>LAT-45 Long range</b> 															
	■	■	■	■	300 to 6,000					1 to 33	1				LHT 45-6 M IU-B5
	■	■	■	■	20 to 10,000	59x42x52	■	18 to 30	1 mm	1 to 33	2	M12	VK.../5		LHT 45-10 M IU-B5
	■	■			200 to 10,000					5	2				LHT 45-10 M P3-B5

## LAT-52 COMPACT

The LAT-52 with IO-Link is suited for distances up to 500 mm, is used in applications in the mm and sub-mm range and is available for three different measuring ranges. The small laser light spot enables the detection of small changes in distance.



Technical data (typ.)	+20 °C, 24 VDC
Emitted light	Red-light laser, 650 nm
Switching output 1	Push-pull, 100 mA, short-circuit proof
Analog output	4 to 20 mA
	0 to 10 V
Service voltage	18 to 30 V DC
No-load current	60 mA
Ambient temperature	0 to +50 °C
Protection type	IP 67
Protection class	III, operation on protective low voltage
Housing material	Die-cast zinc, black powder-coated

	Laser distance sensors	Laser class	Analog output (4 to 20 mA)	Analog output (0 to 10 V)	Detection range (mm)	Housing design Size (mm)	Resolution (mm) Measuring range 1 / measuring range 2	Measuring frequency (Hz)	Cable material/length, Plug connector	Connection cable (optionally available)	Product description
<b>LAT-52 Compact</b>											
	■	1	■	■	30 to 80	51x51x17	0.01	100 to 1200	M12	VK.../5	LAT52-80IU-B5
	■	1	■	■	50 to 200	51x51x17	0.02/0.05	100 to 1200	M12	VK.../5	LAT52-200IU-B5
	■	1	■	■	50 to 500	51x51x17	0.3/0.5	100 to 1200	M12	VK.../5	LAT52-500IU-B5
	■	1	■	■	30 to 80	51x51x17	0.01	1000	M12	VK.../5	LAT52-80IU-RB5
	■	1	■	■	50 to 200	51x51x17	0.02/0.05	750	M12	VK.../5	LAT52-200IU-RB5
	■	1	■	■	50 to 500	51x51x17	0.3/0.5	500	M12	VK.../5	LAT52-500IU-RB5





## LVHT-52 COMPACT

The LVHT-52 is suited for applications that are meant to have a high degree of precision in switching but not measuring. With a detection range of 50 to 500 mm and a precisely adjustable window mode, it is a very efficient solution.



Technical data (typ.)	+20 °C, 24 VDC
Emitted light	Red-light laser, 650 nm
Switching output 1	Push-pull, 100 mA, short-circuit proof
Service voltage	18 to 30 V DC
No-load current	60 mA
Ambient temperature	0 to +50 °C
Protection type	IP 67
Protection class	III, operation on protective low voltage
Housing material	Die-cast zinc, black powder-coated

	Laser distance sensors	Laser class	Analog output (4 to 20 mA)	Analog output (0 to 10 V)	Detection range (mm)	Housing design Size (mm)	Resolution (mm) Measuring range 1 / measuring range 2	Switching frequency (Hz)	Cable material/length, Plug connector	Connection cable (optionally available)	Product description
<b>LVHT-52 Compact</b>											
	■	1			50 to 500	51 x 51 x 17	0.3/0.5	20 to 600	M12	VK.../4	LVHT52-500G3-B4
	■	1			50 to 500	51 x 51 x 17	0.3/0.5	100	M12	VK.../5	LVHT52-500G3-RB4

## LAT-61 PRECISE

Highly precise, quick distance measurements in a range up to 180 mm are the area of application for the LAT-61 optical distance sensor. Its small and precise laser spot makes it possible to determine distances with a resolution into the micrometer range. The integrated display serves to display measured values and to configure the sensor.



Technical data (typ.)	+20 °C, 24 VDC
Emitted light	Red-light laser, 665 nm
Switching output 1	pnp/hpn, 50mA
Switching output 2	pnp/hpn, 50mA
Switching output 3	pnp/hpn, 50mA
Analog output	4 to 20 mA 0 to 10 V
No-load current	< 100 mA
Ambient temperature	-10 to +45 °C
Protection type	IP 67
Protection class	III, operation on protective low voltage
Housing material	Plastic (PBT)

	Laser distance sensors	Laser class	Analog output (4 to 20 mA)	Analog output (0 to 10 V)	Detection range (mm)	Housing design Size (mm)	Digital display	Service voltage (VDC)	Resolution (mm)	Measuring frequency (Hz)	Cable material/length, Plug connector	Connection cable (optionally available)	Product description
<b>LAT-61 Precise</b>													
	■	2	■	■	30 ± 4	60 x 57 x 20	■	21.6 to 26.4	0.5 µm	500 to 5000	5.0m	-	LAT 61 K 30/8 IUPN
				50 ± 10	1.5 µm				500 to 5000	LAT 61 K 50/20 IUPN			
				85 ± 20	2.5 µm				500 to 5000	LAT 61 K 85/40 IUPN			
				120 ± 60	8.0 µm				500 to 5000	LAT 61 K 120/120 IUPN			

## LAT-Z ACCESSORIES FOR OPTICAL DISTANCE SENSORS

This scratch-resistant glass disk protects the front panel of the LAT-45 from damage in harsh ambient conditions.

Protective frame with glass insert for LAT 45...		
		LHT9-45-SRG

## Fork light barriers

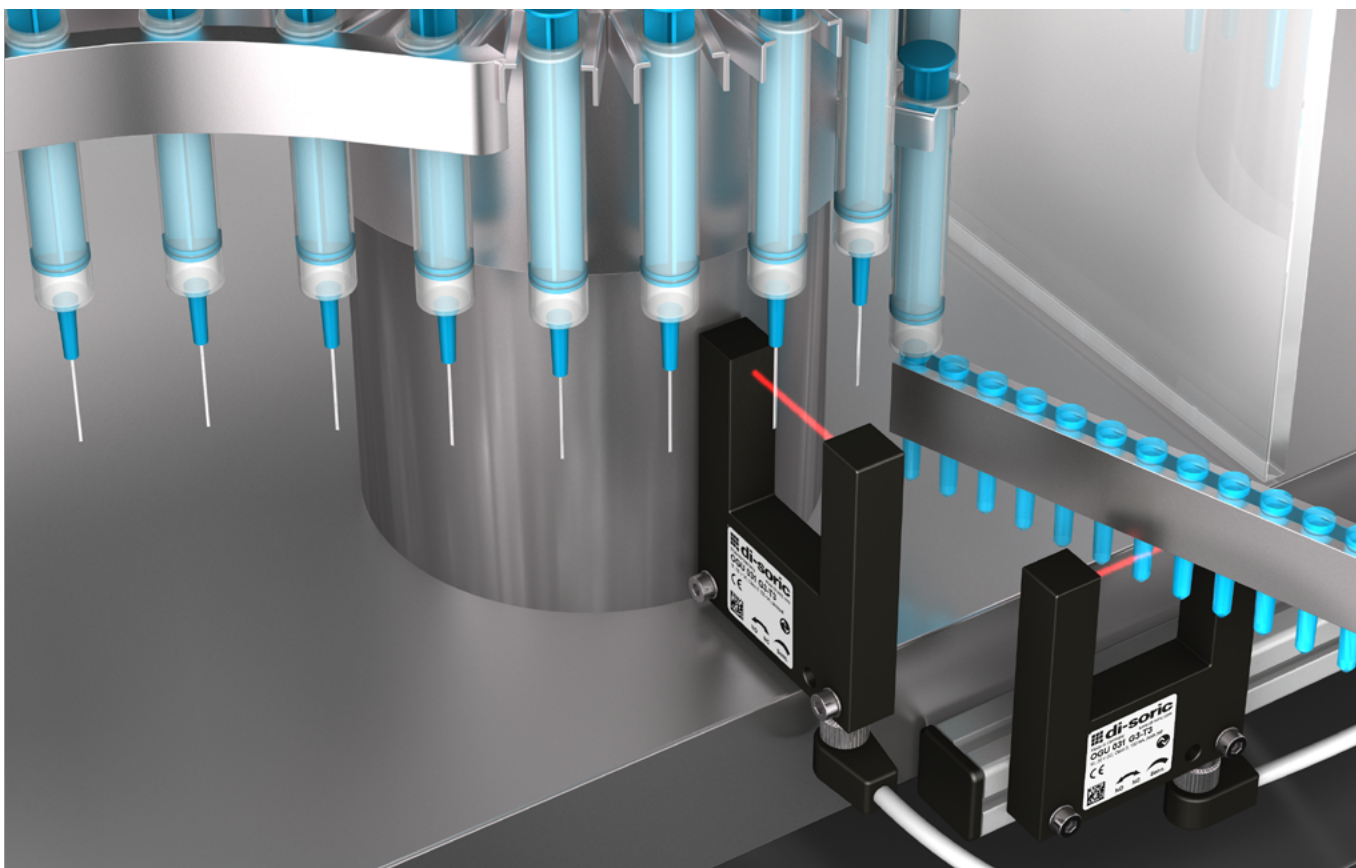

di-soric fork light barriers operate based on the operating principle of through-beam sensors. They are delivered ready to install and do not have to be adjusted afterward. Fork light barriers are used wherever small objects or object positions, regardless of what type of surface they have, must be detected quickly and precisely.



 **di-soric**

OGU	67
OGUP Dirt-resistant	69
OGUL Laser	70
OGU Stainless steel	71
LLGT Measuring	72
OGUZ Special Designs	73
OG-Z Accessories for fork light barriers	73





# OGU

The OGU series with an LED light source is the standard among fork light barriers. The largest range of fork light barriers on the market includes devices with fork openings from 5 mm to 250 mm. OGU fork light barriers offer high resolution and reproducibility with formidable speed. They are operated intuitively using potentiometers, auto-teach or IO-Link. Four preset operation modes provide the option for ideal adaptation to the application. At the same time, IO-Link offers important advantages in configuration and diagnosis.

Technical data (typ.) +20 °C, 24 VDC	
Service voltage	10 to 30 V DC
No-load current	40 mA
Switching output	Push-pull (pnp/npn can be adjusted by IO-Link) 100 mA, NO/NC (can be switched by potentiometer)
Sensitivity adjustment	Adjustable (potentiometer)
Ambient temperature	-25 to 60 °C
Degree of protection	IP 67
Operation modes	<b>Standard</b> (general applications) <b>High Resolution</b> (for detecting very small objects) <b>Power</b> (increased function reserve) <b>Speed</b> (reliable detection of fast-moving parts)
Plug connector	M8, 3-pin
Connection cable	TK... (optionally available)



## Operation modes

- 
**Standard** – General applications
  - 5 kHz
  - Reproducibility: 0.02 mm
- 
**Power** – Increased function reserve
  - Increased transmitting power,
- 
**High Resolution** – For detecting very small objects
  - Resolution improved by 30%
- 
**Speed** – Reliable detection of fast-moving parts
  - 30% higher switching frequency

	Fork width (mm)	Housing design Size (mm)	Red light, 660 nm, clocked	Infrared light, 880 nm	Resolution, smallest detectable part (mm)	Standard factory settings	Adjustable switching frequency (Hz)	IO-Link Interface	Reproducibility (mm)	Die-cast zinc, powder-coated	Aluminum, black varnished/anodized	Product description
	05	25 x 45 x 10	■	■	Ø 0.2 (min. Ø 0.1)	■	10,000 (max. 14,000)	■	0.02	■		OGU 005 G3-T3
	10	25 x 45 x 10		■	Ø 0.3 (min. Ø 0.2)	■	10,000 (max. 14,000)	■	0.02	■		OGU 010 G3-T3
	20	40 x 50 x 10	■	■	Ø 0.3 (min. Ø 0.2)	■	5,000 (max. 8,000)	■	0.02	■		OGU 020 G3-T3 OGU 021 G3-T3
	30	50 x 60 x 10	■	■	Ø 0.3 (min. Ø 0.2)	■	5,000 (max. 8,000)	■	0.02	■		OGU 030 G3-T3 OGU 031 G3-T3
	40	60 x 70 x 10	■		Ø 0.3 (min. Ø 0.2)	■	5,000 (max. 8,000)	■	0.02	■		OGU 041 G3-T3
	50	70 x 80 x 10	■	■	Ø 0.3 (min. Ø 0.2)	■	5,000 (max. 8,000)	■	0.02	■		OGU 050 G3-T3 OGU 051 G3-T3
	60	80 x 80 x 10	■		Ø 0.3 (min. Ø 0.2)	■	5,000 (max. 8,000)	■	0.02		■	OGU 061 G3-T3

	Fork width (mm)	Housing design Size (mm)	Red light, 660 nm, clocked	Infrared light, 880 nm	Resolution, smallest detectable part (mm)	Standard factory settings	Adjustable switching frequency (Hz)	IO-Link Interface	Reproducibility (mm)	Die-cast zinc, powder-coated	Aluminum, black varnished/anodized	Product description	
	70	90 x 80 x 10	■		Ø0.3 (min. Ø0.2)	■	5,000 (max. 8,000)	■	0.02		■	OGU 071 G3-T3	
	80	100 x 80 x 10	■	■	Ø0.3 (min. Ø0.2)	■	5,000 (max. 8,000)	■	0.02	■		OGU 080 G3-T3	
												OGU 081 G3-T3	
	90	110 x 80 x 10	■		Ø0.3 (min. Ø0.2)	■	5,000 (max. 8,000)	■	0.02		■	OGU 91 G3-T3	
	100	120 x 80 x 10	■		Ø0.3 (min. Ø0.2)	■	5,000 (max. 8,000)	■	0.02	■		OGU 101 G3-T3	
	120	144 x 155 x 12		■	Ø0.5 (min. Ø0.3)	■	5,000 (max. 8,000)	■	0.02	■			OGU 120 G3-T3
			■										OGU 121 G3-T3
	170	194 x 140 x 12	■		Ø0.5 (min. Ø0.4)	■	5,000 (max. 8,000)	■	0.03	■			OGU 171 G3-T3
220	244 x 140 x 12	■		Ø1.0 (min. Ø0.8)	■	5,000 (max. 6,500)	■	0.03	■			OGU 221 G3-T3	
250	274 x 140 x 12	■		Ø1.0 (min. Ø0.8)	■	5,000 (max. 6,500)	■	0.03		■		OGU 251 G3-T3	





## OGUP DIRT-RESISTANT

These high-performance fork light barriers have an increased functional reserve, which means that cleaning cycles are reduced to a minimum. They are operated intuitively using potentiometers or IO-Link. Four preset operating modes make ideal adaptation to the application possible, while IO-Link offers important advantages in configuration and diagnosis.

Technical data (typ.) +20 °C, 24 VDC	
Service voltage	10 to 30 VDC (Supply class 2)
Switching output	Push-pull (pnp/npn can be adjusted by IO-Link) 100 mA, NO/NC (can be switched by potentiometer)
Sensitivity adjustment	Adjustable (potentiometer)
Ambient temperature	-25 to 60 °C
Degree of protection	IP 67
Operation modes	<b>Power</b> (increased function reserve) Factory settings <b>Standard</b> (general applications) <b>High Resolution</b> (for detecting very small objects) <b>Speed</b> (reliable detection of fast-moving parts)
Plug connector	M8, 3-pin
Connection cable	TK... (optionally available)



### Operation modes

 <p><b>Standard</b> – General applications</p> <ul style="list-style-type: none"> <li>5 kHz</li> <li>Reproducibility: 0.02 mm</li> </ul>	 <p><b>Power</b> – Increased function reserve</p> <ul style="list-style-type: none"> <li>Increased transmitting power,</li> </ul>
 <p><b>High Resolution</b> – For detecting very small objects</p> <ul style="list-style-type: none"> <li>Resolution improved by 30%</li> </ul>	 <p><b>Speed</b> – Reliable detection of fast-moving parts</p> <ul style="list-style-type: none"> <li>30% higher switching frequency</li> </ul>

	Fork width (mm)	Housing design Size (mm)	Infrared light, 860 nm	No-load current (mA)	Resolution, smallest detectable part (mm)	Power factory settings	Switching frequency (Hz)	Reproducibility (mm)	Die-cast zinc, black, powder-coated	Product description
<b>OGUP Dirt-resistant</b>										
	20	40 x 50 x 10	■	30	Ø 2.0 (min. Ø 0,2)	■	200 (max 8,000)	0.03	■	OGUP 020 G3-T3
	30	50 x 60 x 10								OGUP 030 G3-T3
	50	70 x 80 x 10								OGUP 050 G3-T3
	80	100 x 80 x 10								OGUP 080 G3-T3





## OGUL LASER



The OGUL series is particularly suited for detecting small parts down to 0.05 mm. Using collimated laser red light achieves a high degree of precision of the switching point between transmitter and receiver across the entire fork width. The devices work with a clocked red light laser in the eye-safe laser class 1. The easily visible, small laser point makes quick adjustment to the object possible even with a large amount of ambient light.



Technical data (typ.) +20 °C, 24 VDC	
Emitted light	Red-light laser, 655 nm, clocked
Service voltage	10 to 30 VDC (Supply class 2)
Switching output	Push-pull (pnp/npn can be adjusted by IO-Link) 100 mA, NO/NC (can be switched by potentiometer)
Sensitivity adjustment	Adjustable (potentiometer)
Ambient temperature	-25 to 60 °C
Degree of protection	IP 67
Operation modes	<b>Standard</b> (general applications) <b>High Resolution</b> (for detecting very small objects) <b>Power</b> (increased function reserve) <b>Speed</b> (reliable detection of fast-moving parts)
Plug connector	M8, 3-pin
Connection cable	TK... (optionally available)

### Operation modes

 <p><b>Standard</b> – General applications</p> <ul style="list-style-type: none"> <li>5 kHz</li> <li>Reproducibility: 0.01 mm</li> </ul>	 <p><b>Power</b> – Increased function reserve</p> <ul style="list-style-type: none"> <li>Increased transmitting power,</li> </ul>
 <p><b>High Resolution</b> – For detecting very small objects</p> <ul style="list-style-type: none"> <li>Resolution improved by 30%</li> </ul>	 <p><b>Speed</b> – Reliable detection of fast-moving parts</p> <ul style="list-style-type: none"> <li>100% higher switching frequency</li> </ul>

	Fork width (mm)	Housing design Size (mm)	Transmission light (clocked)	No-load current (mA)	Resolution, smallest detectable part (mm)	Standard factory settings	Switching frequency (Hz)	Reproducibility (mm)	Die-cast zinc, black, powder-coated	Stainless steel V4A (1.4404 / 1.4571)	Product description
<b>OGUL Laser</b>											
	30	50 x 60 x 10	Laser, red	< 30	Ø 0.05 (min. Ø 0,03)	■	5000 (max 10,000)	0.01	■		OGUL 031 G3-T3
	50	70 x 80 x 10			Ø 0.05 (min. Ø 0,03)						OGUL 051 G3-T3
	80	100 x 80 x 10			Ø 0.05 (min. Ø 0,04)						OGUL 081 G3-T3
	120	144 x 90 x 12			Ø 0.10 (min. Ø 0,05)						OGUL 121 G3-T3
	30	50 x 60 x 10	Laser, red	< 30	Ø 0.05 (min. Ø 0,03)	■	5000 (max 10,000)	0.01	■		OGUL 031 G3-T3/V4A
	50	70 x 80 x 10			Ø 0.05 (min. Ø 0,03)						OGUL 051 G3-T3/V4A
	80	100 x 80 x 10			Ø 0.05 (min. Ø 0,04)						OGUL 081 G3-T3/V4A
	120	144 x 90 x 12			Ø 0.10 (min. Ø 0,05)						OGUL 121 G3-T3/V4a



## OGU STAINLESS STEEL

The OGU fork light barriers with V4A stainless steel housing are mechanically and electrically compatible with standard fork light barriers. These devices are used particularly in the pharmaceuticals, beverage and food industries, because they satisfy the particular requirements for easy and reliable cleaning using aggressive media.



Technical data (typ.)	+20 °C, 24 VDC
Service voltage	10 to 30 VDC (Supply class 2)
Switching output	Push-pull (pnp/npn can be adjusted by IO-Link) 100 mA, NO/NC (can be switched by potentiometer)
Sensitivity adjustment	Adjustable (potentiometer)
Ambient temperature	-25 to 60 °C
Degree of protection	IP 67
Operation modes	<b>Standard</b> (general applications) <b>High Resolution</b> (for detecting very small objects) <b>Power</b> (increased function reserve) <b>Speed</b> (reliable detection of fast-moving parts)
Plug connector	M8, 3-pin
Connection cable	TK... (optionally available)

### Operation modes



#### Standard – General applications

- 5 kHz OGU 03x – 12x
- Reproducibility: 0.02 mm



#### Power – Increased function reserve

- Increased transmitting power,



#### High Resolution – For detecting very small objects

- Resolution improved by 30%



#### Speed – Reliable detection of fast-moving parts

- 30% higher switching frequency

	Fork width (mm)	Housing design Size (mm)	Red light, 660 nm, clocked	No-load current (mA)	Resolution, smallest detectable part (mm)	Standard factory settings	Switching frequency (Hz)	Reproducibility (mm)	Stainless steel V4A (1.4404 / 1.4571)	Product description
	10	25 x 45 x 10	■	30	Ø0.2 (min. Ø0.1)	■	5,000 (10,000)	0.02	■	OGU 010 G3-T3/V4A
	30	50 x 60 x 10	■	30	Ø0.3 (min. Ø0.2)	■	5,000 (10,000)	0.02	■	OGU 031 G3-T3/V4A
	50	70 x 80 x 10	■	30	Ø0.3 (min. Ø0.2)	■	5,000 (10,000)	0.02	■	OGU 051 G3-T3/V4A
	80	100 x 80 x 10	■	30	Ø0.3 (min. Ø0.2)	■	5,000 (10,000)	0.02	■	OGU 081 G3-T3/V4A
	120	144 x 90 x 12	■	45	Ø0.5 (min. Ø0.2)	■	5,000 (10,000)	0.02	■	OGU 121 G3-T3/V4A

## LLGT MEASURING

The LLGT line laser fork light barrier with analog output is used for precise edge measurement and for determining diameters. This measuring, high-resolution fork light barrier can be used to reliably capture and analyze even the smallest differences in dimensions.

Technical data (typ.)	+20 °C, 24 VDC
Service voltage	18 to 30 V DC
Resolution	> 20 µm (analog output)
Measuring range	25 mm
Switching output	Push-pull, 150mA (2x)
Switching hysteresis	0.1 mm
Analog output	4 to 20 mA / 0 to 10V switchable
Analog output linearity	± 0.3%
Admissible impedance	≤ 500 ohm / ≥ 1 kohm
Frequency of measuring sequence	200Hz
Characteristics	Trigger input
Display	LED green (operation) LED yellow (switching outputs)
Ambient temperature	+5 to 45 °C
Ambient light immunity	5 kLx
Insulation voltage endurance	500V
Protection type	IP 67
Protection optics	PMMA
Plug connector	M12 connector, 8-pin



	Fork width (mm)	Housing design Size (mm)	Red-light laser line, 650 nm	Laser class (EN60825-1)	No-load current (mA/24 V DC)	Resolution, smallest detectable part (mm)	Switching frequency (Hz)	Aluminum, black anodized	Product description
<b>LLGT Measuring</b>									
	80	150 x 90 x 18	■	1	70	Ø0.5		■	LLGT 081 M 25 IUG8-B8

Accessories for LLGT 081	
	see "Connection technology," page 194

## OGUZ SPECIAL DESIGNS

Fork light barriers in specific designs complete the extensive range that di-soric offers. Differential fork light barriers detect even minimal remission differences (diffuse reflection) for the detection of films that are very thin and as clear as glass. Fork light barriers for flow monitoring provide a continuous switching signal in case of the flow of a preset minimum quantity.

Technical data (typ.)	+20 °C, 24 VDC
Service voltage	10 to 35 V DC
Switching output	pnp, 200 mA, NO/NC switchable
Sensitivity adjustment	4-turn potentiometer
Ambient temperature	-10 to 60 °C
Protection type	IP 67
Plug connector	M8, 3-pin
Connection cable	TK... (optionally available)



	Fork width (mm)	Housing design Size (mm)	Infrared light, 880 nm	No-load current (mA)	Resolution, smallest detectable part (mm)	Switching frequency (Hz)	Reproducibility (mm)	Aluminum, black anodized	Product description
<b>Differential fork light barriers</b>									
	30	50 x 70 x 10	■	35	Ø0.07	5,000	0.01	■	ODG 30 P3K-TSSL
	50	70 x 90 x 10			Ø0.1				ODG 50 P3K-TSSL
	90	110 x 115 x 10			Ø0.25				ODG 90 P3K-TSSL

## OG-Z ACCESSORIES FOR FORK LIGHT BARRIERS

These air blast devices are used to purge dirt and deposits from the front panel. Assembly is done on the assembly bore of the angled / fork light barrier.

Air nozzles (FBE)		
Flexible	Length 60 mm	FBE 60
Flexible	Length 110 mm	FBE 110

## Angled light barriers

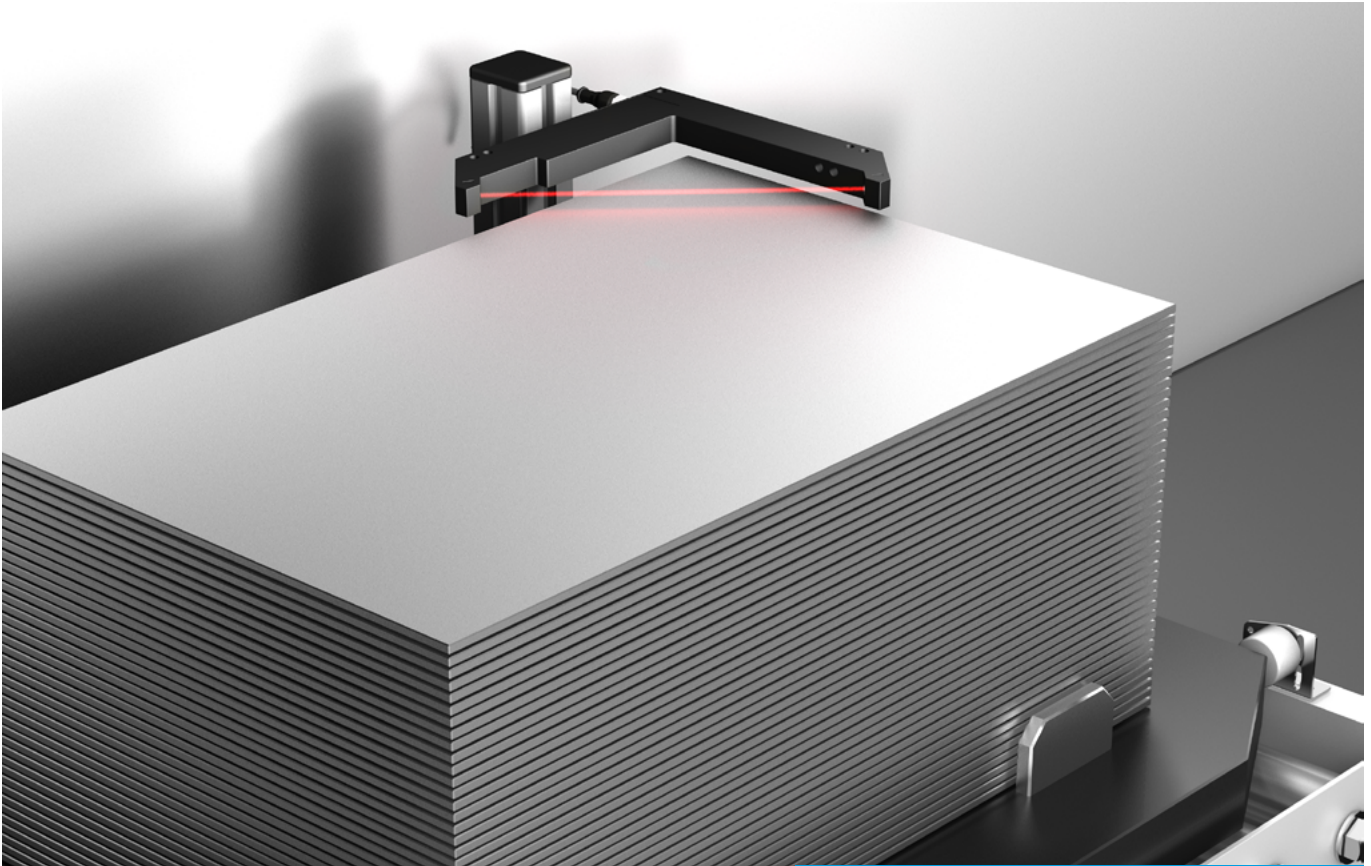

Angled light barriers from di-soric work according to the through-beam principle. They are used, preferably in tight spaces, for fast, surface-independent detection of objects. Since transmitter, receiver and the electronics are located in one housing, they can be mounted quickly. Costly brackets and time-consuming adjustments can be avoided.



 **di-soric**

OGL	75
OGLP Dirt-resistant	76
OGLL Laser	77



The OGL angled light barrier offers unsurpassed performance and can be operated with a potentiometer. The OGL offers high resolution and reproducibility with outstanding speed. It is operated intuitively using potentiometers or IO-Link. Four preset operation modes provide the option for ideal adaptation to the application. At the same time, IO-Link offers important advantages in configuration and diagnosis.



Technical data (typ.) +20 °C, 24 VDC	
Service voltage	10 to 30 VDC (Supply Class 2)
Switching output	Push-pull (pnp/npn can be adjusted by IO-Link) 100 mA, NO/NC (can be switched by potentiometer)
Sensitivity adjustment	Adjustable (potentiometer)
Ambient temperature	-25 to +60 °C
Protection type	IP 67
Operation modes	<b>Standard</b> (general applications) <b>High Resolution</b> (for detecting very small objects) <b>Power</b> (increased function reserve) <b>Speed</b> (reliable detection of fast-moving parts)
Plug connector	M8, 3-pin
Connection cable	TK ... (optionally available)

Operation modes

<p><b>Standard</b> – General applications</p> <ul style="list-style-type: none"> <li>5 kHz</li> <li>Reproducibility: 0.02 mm</li> </ul>	<p><b>Power</b> – Increased function reserve</p> <ul style="list-style-type: none"> <li>Increased transmitting power,</li> </ul>
<p><b>High Resolution</b> – For detecting very small objects</p> <ul style="list-style-type: none"> <li>Resolution improved by 30%</li> </ul>	<p><b>Speed</b> – Reliable detection of fast-moving parts</p> <ul style="list-style-type: none"> <li>30% higher switching frequency</li> </ul>

	Length of the optical axis (mm)	Housing design Size (mm)	Red light, 660 nm	Infrared light, 880 nm	No-load current (mA)	Resolution (mm)	Standard factory settings	Switching frequency (Hz)	Reproducibility (mm)	Die-cast zinc, black powder-coated	Product description
	50	75 x 75 x 10	■	■	< 30	Ø0.3 (min. Ø0.2)	■	5,000 (max. 10,000)	0.02	■	OGL 050 G3-T3 <sup>1)</sup> OGL 051 G3-T3 <sup>1)</sup>
	80	105 x 105 x 10	■	■	< 30	Ø0.3 (min. Ø0.2)	■	5,000 (max. 10,000)	0.02	■	OGL 080 G3-T3 <sup>1)</sup> OGL 081 G3-T3 <sup>1)</sup>
	120	150 x 150 x 12	■	■	< 30	Ø0.5 (min. Ø0.4)	■	5,000 (max. 10,000)	0.02	■	OGL 120 G3-T3 <sup>1)</sup> OGL 121 G3-T3 <sup>1)</sup>

**Air nozzle devices FBE for OGLP xx G3-T3**

see "OG-Z Accessories for fork light barriers," page 73

## OGLP DIRT-RESISTANT

The high-performance angled light barriers from di-soric have an increased functional reserve. In the devices with contamination indicator, the cleaning cycles are reduced to a minimum.

Technical data (typ.) +20°C, 24 VDC	OGLP xx G3-T3	OGL xx/xx P6L-IBS
Service voltage	10 to 30 VDC (Supply Class 2)	10 to 35 V DC
Switching output	Push-pull (pnp/npn can be adjusted by IO-Link) 100mA, NO/NC (can be switched by potentiometer)	pnp, 200 mA, NO
Sensitivity adjustment	Adjustable (potentiometer)	
Ambient temperature	-25 to +60 °C	-10 to +60 °C
Protection type	IP 67	IP 67
Operation modes	<b>Standard</b> (general applications) <b>High Resolution</b> (for detecting very small objects) <b>Power</b> (increased function reserve) <b>Speed</b> (reliable detection of fast-moving parts)	
Plug connector	M8, 3-pin	M12, 4-pin
Connection cable	TK ... (optionally available)	VK .../4 (optionally available)



### Operation modes OGLP xx G3-T3



- Standard** – General applications
- 5 kHz
  - Reproducibility: 0.02 mm



- Power** – Increased function reserve
- Increased transmitting power,



- High Resolution** – For detecting very small objects
- Resolution improved by 30%



- Speed** – Reliable detection of fast-moving parts
- 30% higher switching frequency

	Length of the optical axis (mm)	Housing design Size (mm)	Infrared light, 860 nm	Red light, 660 nm	No-load current (mA)	Resolution (mm)	Power factory settings	Switching frequency (Hz)	Reproducibility (mm)	Contamination indicator / output	IO-Link	Die-cast zinc, black powder-coated	Die-cast zinc, natural	Product description
<b>OGLP Dirt-resistant</b>														
	50	75 x 75 x 10	■		< 30	Ø0.3 (min. Ø0.2)	■	5,000 (max. 8,000)	0.02	-	■	■	-	OGLP 050 G3-T3
	80	105 x 105 x 10	■		< 30	Ø0.3 (min. Ø0.2)	■	5,000 (max. 8,000)	0.02	-	■	■	-	OGLP 080 G3-T3
	120	150 x 150 x 12	■		< 30	Ø0.5 (min. Ø0.4)	■	5,000 (max. 8,000)	0.03	-	■	■	-	OGLP 120 G3-T3
	40	60 x 83 x 10		■	45	-	■	200	-	■	-	-	■	OGL 50/31 P6L-IBS
	60	65 x 106 x 10		■	45	-	■	200	-	■	-	-	■	OGL 55/54 P6L-IBS

### Air nozzle devices FBE for OGLP xx G3-T3

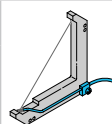

see "OG-Z Accessories for fork light barriers," page 73

## OGLL LASER

The OGLL laser angled light barrier is particularly suited for detecting small parts down to 0.05 mm. Using collimated laser red light achieves a high degree of precision of the switching point between transmitter and receiver across the entire fork width. The devices work with a clocked red light laser in the eye-safe laser class 1. The easily visible, small laser point makes quick adjustment to the object possible even with a large amount of ambient light.



Technical data (typ.) +20 °C, 24 VDC	
Service voltage	10 to 30 VDC (Supply Class 2)
Switching output	Push-pull (pnp/npn can be adjusted by IO-Link) 100 mA, NO/NC (can be switched by potentiometer)
Sensitivity adjustment	Adjustable (potentiometer)
Ambient temperature	-25 to +60 °C
Protection type	IP 67
Operation modes	<b>Standard</b> (general applications) <b>High Resolution</b> (for detecting very small objects) <b>Power</b> (increased function reserve) <b>Speed</b> (reliable detection of fast-moving parts)
Plug connector	M8, 3-pin
Connection cable	TK ... (optionally available)

### Operation modes



**Standard** – General applications

- 5 kHz
- Reproducibility: 0.01 mm



**Power** – Increased function reserve

- Increased transmitting power,



**High Resolution** – For detecting very small objects

- Resolution improved by 30%



**Speed** – Reliable detection of fast-moving parts

- 100% higher switching frequency

	Length of the optical axis (mm)	Housing design Size (mm)	Transmission light (clocked)	Red-light laser, 670 nm	No-load current (mA)	Resolution (mm)	Standard factory settings	Switching frequency (Hz)	Reproducibility (mm)	Die-cast zinc, black powder-coated	Product description
<b>OGLL Laser</b>											
	50	75 x 75 x 10	■	■	< 30	Ø0.05 (min. Ø0.03)	■	5000 (10,000)	0.01	■	OGLL 051 G3-T3
	80	105 x 105 x 10		■	< 30	Ø0.05 (min. Ø0.04)	■	5000 (10,000)	0.01	■	OGLL 081 G3-T3
	120	150 x 150 x 12	■	■	< 30	Ø0.10 (min. Ø0.05)	■	5000 (10,000)	0.01	■	OGLL 121 G3-T3

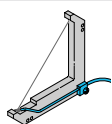

### Air nozzles (FBE)

see "OG-Z Accessories for fork light barriers," page 73

## Frame light barriers

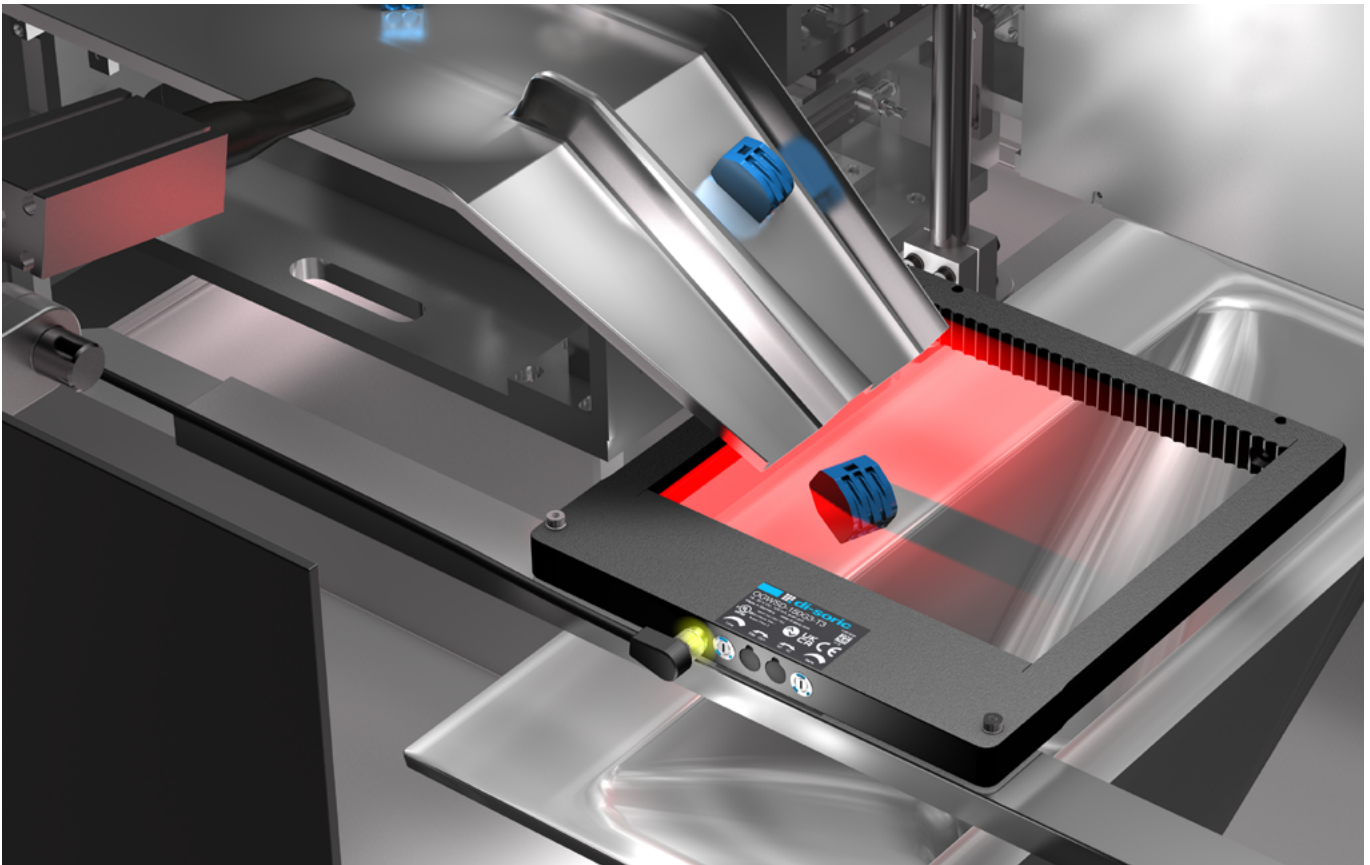

Our frame light barriers detect very quickly moving and static objects independent of the object position and across the entire detection range. Frame light barriers are ready for installation and immediately operational and are used wherever metallic or non-metallic objects are to be detected not only at one position, but across a range, quickly and independent of the surface.



 **di-soric**

OGWSO Frame design

79

OGWTI Open fork design

79



## OGWSD FRAME DESIGN

Frame light barriers of the OGWSD series have a frame design and detect objects in a range of up to 300 x 397 mm. The devices are ideal for harsh machine environments with heavy mechanical stresses. The OGWSD has a robust metal housing with impact protection and crossbar and can quickly be set via potentiometers. IO-Link offers advantages in configuration and diagnosis and enables Industry 4.0 system designs.



Technical data (typ.)	+20 °C, 24 VDC
Emitted light	LED infrared
Response time	0.05 ms
Release time	0.05 to 10000 ms
Pulse stretching	0 to 150 ms
Ambient temperature	-10 to 60 °C
Protection type	IP 67
Housing material	Aluminum, anodized

	Detection range	Size (mm)	Functional principle S = static / D = dynamic	Switching output	No-load current (mA)	Resolution, dynamic operation (mm)	Resolution, static operation (mm)	Service voltage (VDC)	Plug connector	Connection cable (optionally available)	Product description
<b>OGWSD Frame design</b>											
	25 x 22	65.5 x 55 x 15	S/D	100 mA NO/NC	45	0.7	1.0	18 to 30	M8	TK ...	OGWSD-25G3-T3
	40 x 49	108.5 x 70 x 15				0.7	1.0				OGWSD-40G3-T3
	70 x 62	121.5 x 100 x 15				1.5	2.0				OGWSD-70G3-T3
	100 x 92	151.5 x 130 x 15				2.5	3.0				OGWSD-100G3-T3
	150 x 142	201.5 x 180 x 15				3.0	5.0				OGWSD-150G3-T3
	250 x 242	301.5 x 280 x 15				5.0	8.0				OGWSD-250G3-T3
	300 x 398	457 x 330 x 15				5.0	10.0				OGWSD-300G3-T3

## OGWTI OPEN FORK DESIGN

Frame light barriers of the OGWTI series have an open fork design and detect objects in a range of up to 100 x 100 mm. With their compact design, the devices are ideal for integration in machinery. OGWTI has a robust metal housing and can be operated intuitively via a keypad. IO-Link offers advantages in configuration and diagnosis and enables Industry 4.0 system designs.



Technical data (typ.)	+20 °C, 24 VDC
Emitted light	LED infrared
Response time	0.5 ms
Release time	0.05 to 10000 ms
Pulse stretching	20 ms, adjustable
Ambient temperature	-10 to 60 °C
Protection type	IP 67
Housing material	Die-cast zinc, powder-coated

	Detection range	Size (mm)	Functional principle S = static / D = dynamic	Switching output	No-load current (mA)	Resolution, dynamic operation (mm)	Resolution, static operation (mm)	Service voltage (VDC)	Plug connector	Connection cable (optionally available)	Product description
<b>OGWTI Open fork design</b>											
	30 x 30	66 x 54 x 12	S/D	100 mA NO/NC	45	0.7	1.0	18 to 30	M8	TKto /4	OGWTI-30G3-T4
	50 x 50	86 x 74 x 12				1.0	1.5				OGWTI-50G3-T4
	80 x 80	116 x 104 x 12				1.5	2.0				OGWTI-80G3-T4
	100 x 100	136 x 124 x 12				2.5	3.0				OGWTI-100G3-T4

# Light curtains

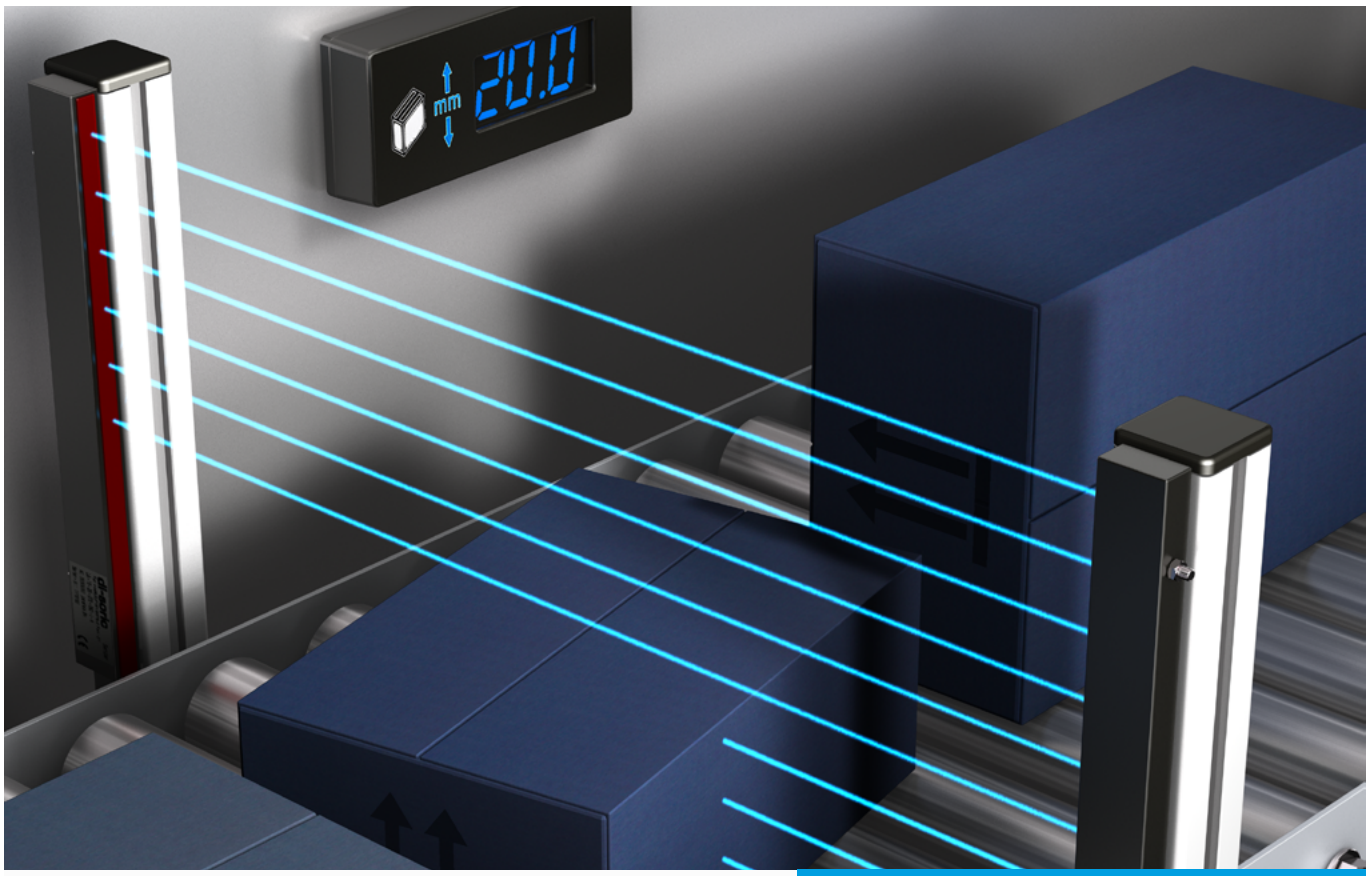

Our light curtains detect and measure objects in a large detection or measuring field. The light curtain systems operate on the principle of multiple through-beam sensors whose output signals are either interlinked (switching light curtains) or evaluated individually (measuring light curtains). Through different resolutions and elevations, they can be used in many applications.

LA Switching	81
LI Measuring	84
LI-A Evaluation electronics for LI series	87





## LA SWITCHING



The area of application of the LA switching light curtains is object detection. The devices were designed in a cost-optimized manner for simple applications. Slim construction, integrated switching outputs and quick commissioning are their distinguishing features.



Technical data (typ.)	+20°C, 24 VDC
Operating distance	0.7 to 4.0 m / set to 4.0 m at the factory
Number of beams	8 to 112
Beam separation	12.5/25/50/112 mm
Monitoring height	88 to 2571 mm
Emitted light	Infrared light, 880 nm, clocked
Service voltage	20.4 to 28.8 V DC
Outputs	Transistor pnp (switching output and alarm output)
Current-carrying capacity	200 mA, short-circuit proof
Ambient temperature	-10 to +45 °C
Degree of protection	IP 54, optionally IP 65
EMC directives	EN 61000-6-3:2001/EN 61000-6-1:2001
Housing material	Aluminum bar profile

Beam separation (mm)	Number of beams	Monitoring height H (mm)	Profile length L ca. (mm)	Design	Number of threaded bolts	Dimension A (mm)	Dimension B (mm)	Dimension X (mm)	Dimension Y (mm)	Light switching	Dark switching	Product description	Product description					
<b>LA Switching</b>												<b>Horizontal beam evaluation</b>	<b>Diagonal beam evaluation</b>					
12.5	8	88	260	I	2	30	200	13.5	153.5	■		LA 8-12.5-88-260 I-H	LA-D 8-12.5-88-260 I-H					
													■		LA 8-12.5-88-260 I-D	LA-D 8-12.5-88-260 I-D		
	16	188	360		2	30	300						■		LA 16-12.5-188-360 I-H	LA-D 16-12.5-188-360 I-H		
														■		LA 16-12.5-188-360 I-D	LA-D 16-12.5-188-360 I-D	
	24	288	460		2	80	300							■		LA 24-12.5-288-460 I-H	LA-D 24-12.5-288-460 I-H	
															■		LA 24-12.5-288-460 I-D	LA-D 24-12.5-288-460 I-D
	32	388	560		2	80	400								■		LA 32-12.5-388-560 I-H	LA-D 32-12.5-388-560 I-H
															■		LA 32-12.5-388-560 I-D	LA-D 32-12.5-388-560 I-D
	40	488	660		2	80	500								■		LA 40-12.5-488-660 I-H	LA-D 40-12.5-488-660 I-H
															■		LA 40-12.5-488-660 I-D	LA-D 40-12.5-488-660 I-D
	48	588	760		2	30	700								■		LA 48-12.5-588-760 I-H	LA-D 48-12.5-588-760 I-H
															■		LA 48-12.5-588-760 I-D	LA-D 48-12.5-588-760 I-D
56	688	860	2	80	700						■		LA 56-12.5-688-860 I-H	LA-D 56-12.5-688-860 I-H				
											■		LA 56-12.5-688-860 I-D	LA-D 56-12.5-688-860 I-D				
64	788	960	3	80	400						■		LA 64-12.5-788-960 I-H	LA-D 64-12.5-788-960 I-H				
											■		LA 64-12.5-788-960 I-D	LA-D 64-12.5-788-960 I-D				
72	888	1,060	3	130	400						■		LA 72-12.5-888-1060 I-H					
											■		LA 72-12.5-888-1060 I-D					
80	988	1,160	3	80	500						■		LA 80-12.5-988-1160 I-H					
											■		LA 80-12.5-988-1160 I-D					
88	1,088	1,260	3	30	600						■		LA 88-12.5-1088-1260 I-H					
											■		LA 88-12.5-1088-1260 I-D					

Beam separation (mm)	Number of beams	Monitoring height H (mm)	Profile length L ca. (mm)	Design	Number of threaded bolts	Dimension A (mm)	Dimension B (mm)	Dimension X (mm)	Dimension Y (mm)	Light switching	Dark switching	Product description	Product description	
LA Switching											 Horizontal beam evaluation	 Diagonal beam evaluation		
12.5	96	1,188	1,360	I	3	80	600	13.5	13.5	■		LA 96-12.5-1188-1360 I-H		
										■		LA 96-12.5-1188-1360 I-D		
	104	1,288	1,460		3	130				400	■		LA 104-12.5-1288-1460 I-H	
											■		LA 104-12.5-1288-1460 I-D	
	112	1,388	1,560		4	30				500	■		LA 112-12.5-1388-1560 I-H	
											■		LA 112-12.5-1388-1560 I-D	
25	8	175	360	2	30	300	20	160	■		LA 8-25-175-360 I-H	LA-D 8-25-175-360 I-H		
									■		LA 8-25-175-360 I-D	LA-D 8-25-175-360 I-D		
	16	375	560	2	80	400			■		LA 16-25-375-560 I-H	LA-D 16-25-375-560 I-H		
									■		LA 16-25-375-560 I-D	LA-D 16-25-375-560 I-D		
	24	575	760	2	30	700			■		LA 24-25-575-760 I-H	LA-D 24-25-575-760 I-H		
									■		LA 24-25-575-760 I-D	LA-D 24-25-575-760 I-D		
	32	775	960	3	80	400			■		LA 32-25-775-960 I-H	LA-D 32-25-775-960 I-H		
									■		LA 32-25-775-960 I-D	LA-D 32-25-775-960 I-D		
	40	975	1,160	3	80	500			■		LA 40-25-975-1160 I-H	LA-D 40-25-975-1160 I-H		
									■		LA 40-25-975-1160 I-D	LA-D 40-25-975-1160 I-D		
	48	1,175	1,360	3	80	600			■		LA 48-25-1175-1360 I-H	LA-D 48-25-1175-1360 I-H		
									■		LA 48-25-1175-1360 I-D	LA-D 48-25-1175-1360 I-D		
	56	1,375	1,560	4	80	500			■		LA 56-25-1375-1560 I-H	LA-D 56-25-1375-1560 I-H		
									■		LA 56-25-1375-1560 I-D	LA-D 56-25-1375-1560 I-D		
	64	1,575	1,760	4	130	500			■		LA 64-25-1575-1760 I-H	LA-D 64-25-1575-1760 I-H		
									■		LA 64-25-1575-1760 I-D	LA-D 64-25-1575-1760 I-D		
	72	1,775	1,960	4	80	600			■		LA 72-25-1775-1960 I-H			
									■		LA 72-25-1775-1960 I-D			
80	1,975	2,160	5	80	500	■		LA 80-25-1975-2160 I-H						
						■		LA 80-25-1975-2160 I-D						
88	2,175	2,360	5	140	520	■		LA 88-25-2175-2360 I-H						
						■		LA 88-25-2175-2360 I-D						

Beam separation (mm)	Number of beams	Monitoring height H (mm)	Profile length L ca. (mm)	Design	Number of threaded bolts	Dimension A (mm)	Dimension B (mm)	Dimension X (mm)	Dimension Y (mm)	Light switching	Dark switching	Product description			
<b>LA Switching</b>											 <b>Horizontal beam evaluation</b>	 <b>Diagonal beam evaluation</b>			
50	8	350	560	I	2	80	400	20	185	■		LA 8-50-350-560 I-H	LA-D 8-50-350-560 I-H		
												■		LA 8-50-350-560 I-D	LA-D 8-50-350-560 I-D
	16	750	960		3	80	400			■		LA 16-50-750-960 I-H	LA-D 16-50-750-960 I-H		
												■		LA 16-50-750-960 I-D	LA-D 16-50-750-960 I-D
	24	1,150	1,360		3	80	600			■		LA 24-50-1150-1360 I-H	LA-D 24-50-1150-1360 I-H		
												■		LA 24-50-1150-1360 I-D	LA-D 24-50-1150-1360 I-D
	32	1,550	1,760		4	130	500			■		LA 32-50-1550-1760 I-H	LA-D 32-50-1550-1760 I-H		
												■		LA 32-50-1550-1760 I-D	LA-D 32-50-1550-1760 I-D
	40	1,950	2,160	5	130	500	■		LA 40-50-1950-2160 I-H	LA-D 40-50-1950-2160 I-H					
									■		LA 40-50-1950-2160 I-D	LA-D 40-50-1950-2160 I-D			
	48	2,350	2,560	5	80	600	■		LA 48-50-2350-2560 I-H	LA-D 48-50-2350-2560 I-H					
										■		LA 48-50-2350-2560 I-D	LA-D 48-50-2350-2560 I-D		
112	8	783	1,050	I	3	125	400	20	245	■		LA 8-112-783-1050 I-H	LA-D 8-112-783-1050 I-H		
												■		LA 8-112-783-1050 I-D	LA-D 8-112-783-1050 I-D
	16	1,677	1,950		4	75	600			■		LA 16-112-1677-1950 I-H	LA-D 16-112-1677-1950 I-H		
												■		LA 16-112-1677-1950 I-D	LA-D 16-112-1677-1950 I-D

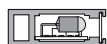

10x27 mm

**LA...Q**

Light curtains in housing design LA...Q are optionally available upon request



## LI MEASURING

The LI measuring light curtains are used in object measurement and for challenging measuring and detection tasks. The most important features are high resolution and a short response time, as well as their slim construction for simple integration. An additional evaluation unit is required to use them.





Technical data (typ.) +20°C, 24 VDC	
Operating distance	0.25 to 6.0 m can be adjusted using the evaluation electronics
Number of beams	8 to 344
Beam separation	5/10/12.5/25/50/112 mm
Monitoring height	35 to 2375 mm
Emitted light	Infrared light, 880 nm
	200 mA, short-circuit proof
Ambient temperature	-10 to +45 °C
Degree of protection	IP 54, optionally IP 65 (EN 61000-6-3:2001/EN 61000-6-1:2001)
Housing material	Aluminum bar profile

	Beam separation (mm)	Number of beams	Monitoring height H (mm)	Profile length L ca. (mm)	Design	Dimension X (mm)	Dimension Y (mm)	Product description
	5	8	35	70	T	17.5	17.5	LI 8-5-35-70 T
			16	110				LI 16-5-75-110 T
			24	150				LI 24-5-115-150 T
			32	190				LI 32-5-155-190 T
			40	230				LI 40-5-195-230 T
			48	270				LI 48-5-235-270 T
			56	310				LI 56-5-275-310 T
			64	350				LI 64-5-315-350 T
			72	390				LI 72-5-355-390 T
			80	430				LI 80-5-395-430 T
			88	470				LI 88-5-435-470 T
			96	510				LI 96-5-475-510 T
			104	550				LI 104-5-515-550 T
			112	590				LI 112-5-555-590 T
			120	630				LI 120-5-595-630 T
			128	670				LI 128-5-635-670 T
			136	710				LI 136-5-675-710 T
			144	750				LI 144-5-715-750 T
			152	790				LI 152-5-755-790 T
			160	830				LI 160-5-795-830 T
			168	870				LI 168-5-835-870 T
			176	910				LI 176-5-875-910 T
			184	950				LI 184-5-915-950 T
			192	990				LI 192-5-955-990 T
			200	1,030				LI 200-5-995-1030 T
			208	1,070				LI 208-5-1035-1070 T
			216	1,110				LI 216-5-1075-1110 T
			224	1,150				LI 224-5-1115-1150 T
			232	1,190				LI 232-5-1155-1190 T
			240	1,230				LI 240-5-1195-1230 T
			248	1,270				LI 248-5-1235-1270 T
			256	1,310				LI 256-5-1275-1310 T
			264	1,350				LI 264-5-1315-1350 T
			272	1,390				LI 272-5-1355-1390 T
280	1,430	LI 280-5-1395-1430 T						
288	1,470	LI 288-5-1435-1470 T						
296	1,510	LI 296-5-1475-1510 T						
344	1,750	LI 344-5-1715-1750 T						

	Beam separation (mm)	Number of beams	Monitoring height H (mm)	Profile length L ca. (mm)	Design	Number of threaded bolts	Dimension A (mm)	Dimension B (mm)	Dimension X (mm)	Dimension Y (mm)	Product description	
	<b>LI Measuring</b>											
	  <b>Horizontal or diagonal beam evaluation</b>											
	10	8	70	130	I	I	2	20	90	13.5	38.5	LI 8-10-70-130 I
		16	150	210			2	55	100			LI 16-10-150-210 I
		24	230	290			2	45	200			LI 24-10-230-290 I
		32	310	370			2	35	300			LI 32-10-310-370 I
		40	390	450			2	75	300			LI 40-10-390-450 I
		48	470	530			2	65	400			LI 48-10-470-530 I
		56	550	610			2	105	400			LI 56-10-550-610 I
		64	630	690			2	45	600			LI 64-10-630-690 I
		72	710	770			2	35	700			LI 72-10-710-770 I
		80	790	850			2	75	700			LI 80-10-790-850 I
		88	870	930			2	65	800			LI 88-10-870-930 I
		96	950	1,010			3	105	400			LI 96-10-950-1010 I
		104	1,030	1,090			3	145	400			LI 104-10-1030-1090 I
		112	1,110	1,170			3	85	500			LI 112-10-1110-1170 I
		120	1,190	1,250			3	125	500			LI 120-10-1190-1250 I
		128	1,270	1,330			3	65	600			LI 128-10-1270-1330 I
	136	1,350	1,410	3	105	600	LI 136-10-1350-1410 I					
	144	1,430	1,490	4	145	400	LI 144-10-1430-1490 I					
	152	1,510	1,570	4	35	500	LI 152-10-1510-1570 I					
	160	1,590	1,650	4	75	500	LI 160-10-1590-1650 I					
	12.5	8	88	140	I	I	2	25	90	13.5	38.5	LI 8-12.5-88-140 I
		16	188	240			2	70	100			LI 16-12.5-188-240 I
		24	288	340			2	70	200			LI 24-12.5-288-340 I
		32	388	440			2	70	300			LI 32-12.5-388-440 I
		40	488	540			2	70	400			LI 40-12.5-488-540 I
		48	588	640			2	70	500			LI 48-12.5-588-640 I
56		688	740	2			70	600	LI 56-12.5-688-740 I			
64		788	840	2			70	700	LI 64-12.5-788-840 I			
72		888	940	2			70	800	LI 72-12.5-888-940 I			
80		988	1,040	3			120	400	LI 80-12.5-988-1040 I			
88		1,088	1,140	3			70	500	LI 88-12.5-1088-1140 I			
96		1,188	1,240	3			120	500	LI 96-12.5-1188-1240 I			
104		1,288	1,340	3			70	600	LI 104-12.5-1288-1340 I			
112		1,388	1,440	3			120	600	LI 112-12.5-1388-1440 I			
120		1,488	1,540	4			170	400	LI 120-12.5-1488-1540 I			
128		1,588	1,640	4			70	500	LI 128-12.5-1588-1640 I			
136	1,688	1,740	4	120	500	LI 136-12.5-1688-1740 I						
144	1,788	1,840	4	170	500	LI 144-12.5-1788-1840 I						

**Light curtains with greater monitoring height H (max. 196 beams)**

Available on request!

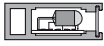
	Beam separation (mm)	Number of beams	Monitoring height H (mm)	Profile length L ca. (mm)	Design	Number of threaded bolts	Dimension A (mm)	Dimension B (mm)	Dimension X (mm)	Dimension Y (mm)	Product description
<b>LI Measuring</b>											 <b>Horizontal or diagonal beam evaluation</b>
	25	8	175	240	I	2	70	100	20	45	LI 8-25-175-240 I
		16	375	440		2	70	300			LI 16-25-375-440 I
		24	575	640		2	70	500			LI 24-25-575-640 I
		32	775	840		2	70	700			LI 32-25-775-840 I
		40	975	1,040		3	120	400			LI 40-25-975-1040 I
		48	1,175	1,240		3	125	500			LI 48-25-1175-1240 I
		56	1,375	1,440		3	120	600			LI 56-25-1375-1440 I
		64	1,575	1,640		4	70	500			LI 64-25-1575-1640 I
		72	1,775	1,840		4	170	500			LI 72-25-1775-1840 I
		80	1,975	2,040		4	120	600			LI 80-25-1975-2040 I
		88	2,175	2,240		5	120	500			LI 88-25-2175-2240 I
	96	2,375	2,440	5	165	520	LI 96-25-2375-2440 I				
	50	8	350	440	I	2	70	300	20	70	LI 8-50-350-440 I
		16	750	840		2	70	700			LI 16-50-750-840 I
		24	1,150	1,240		3	120	500			LI 24-50-1150-1240 I
		32	1,550	1,640		4	70	500			LI 32-50-1550-1640 I
		40	1,950	2,040		4	120	600			LI 40-50-1950-2040 I
		48	2,350	2,440		5	180	520			LI 48-50-2350-2440 I
	112	4	336	490	I	2	95	300	20	130	LI 4-112-336-490 I
		8	783	940		2	70	800			LI 8-112-783-940 I
		12	1,230	1,380		3	90	600			LI 12-112-1230-1380 I
		16	1,677	1,830		4	165	500			LI 16-112-1677-1830 I
		20	2,124	2,280		5	175	500			LI 20-112-2124-2280 I
	 <b>LI...Q</b>										
	Light curtains in housing design LI...Q are optionally available upon request										
	10x27 mm										



## LI-A EVALUATION ELECTRONICS FOR LI SERIES



Technical data (typ.)		at +20 °C, 24 VDC	
Operating distance	0.4 to 6.0m, autocalibration	LED display	Status indicator/ error indicator
Number of beams	See Light curtains LL...	Ambient temperature	0 to +40 °C
Switching frequency	10Hz	Protection type	IP 54
Switching capacity	250VDC, 250W 400V AC, 2000VA	Protection class	III, operation on protective low voltage
Output function	Light switching	EMC directives	EN 61000-6-1: 2001
beam evaluation	Multiplexing		EN 61000-6-3: 2001
Cycle time per light beam	down to 0.08 ms/beam (Depending on range)	Housing material	ABS gray

	Number of light curtains being operated	Switching output (relay 10Hz)	Analog outputs	Service voltage (VDC)	Profibus interface D-Sub, 9-pin (address adjustable)	Ethernet / IP	Profinet	Dimensions LxWxH (mm)	Product description
<b>Evaluation electronics LVB ..., switching</b>									
	1	1		19 to 30				57.5 x 120 x 200	LVB-24VDC
	1	1		230 (+5/-10%)				57.5 x 120 x 200	LVB-230VAC

Technical data (typ.)		at +20 °C, 24 VDC	
Operating distance	0.25 to 6.0m, adjustable	LED display	Error indicator
Number of beams	max. 500	Ambient temperature	0 to +40 °C
Service voltage	20 to 26 V DC	Protection type	IP 00
Outputs	See the graphic above		IP 65 with optional outer housing
Switching capacity	250 mA	Protection class	III, operation on protective low voltage
Output function	Configurable	EMC directives	EN 61000-6-1: 2001
beam evaluation	Parameters can be configured horizontally / diagonally		EN 61000-6-3: 2001
Cycle time per light beam	0.05 ms (depends on configuration and range of light curtain)	Housing material	Plastic

	Number of light curtains being operated	Configurable inputs (24 VDC, 12 mA, 3,000 Hz)	Outputs (24 VDC, 0.25 A, PNP)	Analog outputs (0 to 10 V)	3 combined IOs	RS 232	Configuration by means of DIP series	CANopen interface	Profibus interface D-Sub, 9-pin (address adjustable)	Ethernet / IP	Profinet	Dimensions LxWxH (mm)	Product description		
<b>Evaluation electronics LVE ... / LVX ..., measuring</b>															
	1	1	1									88 x 126 x 60	LVE <sup>1)</sup>		
			1							■			163 x 126 x 60	LVE-PBI <sup>1)</sup>	
			1				■	■	■		■			130 x 126 x 60	LVE-ENI <sup>1)</sup>
			1	2								■		163 x 126 x 60	LVE-PNI <sup>1)</sup>
			1	2										124 x 126 x 60	LVE-ALX <sup>1)</sup>
	17												147 x 126 x 60	LVE-016 <sup>1)</sup>	
	2	1	3										125 x 126 x 60	LVX <sup>1)</sup>	
3									■			200 x 126 x 60	LVX-PBI <sup>1)</sup>		
3						■	■	■	■		■		200 x 126 x 60	LVX-PNI <sup>1)</sup>	
3			2										161 x 126 x 60	LVX-ALX <sup>1)</sup>	
19													184 x 126 x 60	LVX-016 <sup>1)</sup>	

<sup>1)</sup> The evaluation electronics are configured at the factory using the customer's application.

## High performance light barriers

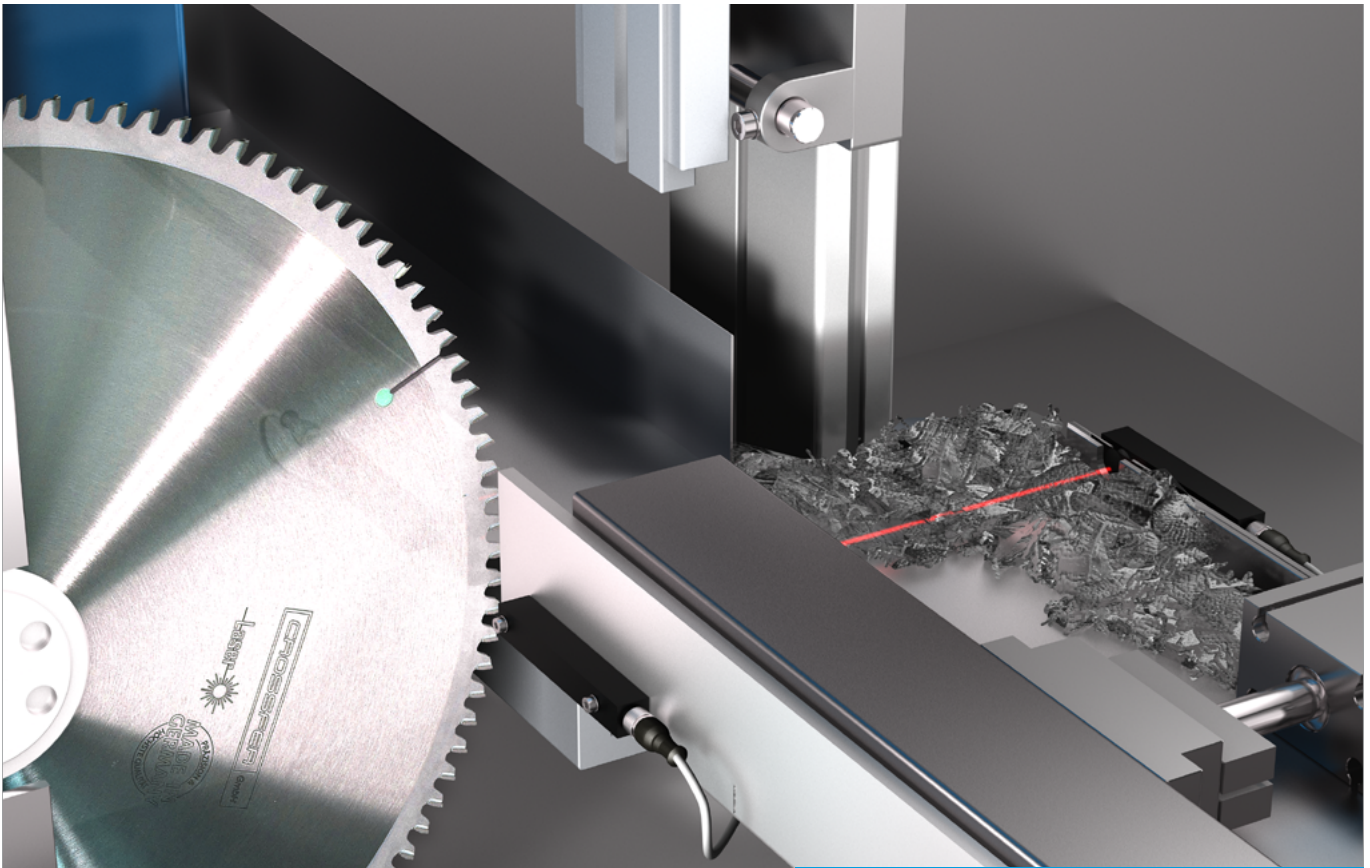

Our high-performance light barriers are available as threaded and rectangular models, which can be combined with one another. These products penetrate even heavy contamination, such as dust, oil and dirty water. They are optimized for the highest functionality and have a range of up to 50 m.



 **di-soric**

OP-M12	89
OP-Q12	90
OP-50	91

## OP-M12

The threaded M12 model consists of a transmitter and receiver in a compact construction and simple threaded mounting. Thanks to the robust stainless steel housing, the systems are resistant to vibrations and shaking and therefore do not have to be continually readjusted.



Technical data (typ.)	+20°C, 24 VDC
Emitted light	Infrared light, clocked
Service voltage	10 to 35V DC
Ambient temperature	-20to+60°C

	Range (opening angle 15°) when operating with OSP 12 VLF ... / OSPQ 12 MLFL ... (m)	Operating distance (opening angle 6°) When operating with OSP 12 VHF ... / OSPQ 12 MHFL ... (m)	Housing design Size (mm)	Transmitter (T) / Receiver (R)	Dispersion angle / opening angle	Switching output	NC (nnp) / NO (nnp)	NO (pnp) / NC (nnp)	NO/NC	Switching frequency (Hz)	Protection type	Housing material	integrated heating function	Cable material/length, Plug connector	Connection cable (optionally available)	Product description
<b>OP-M12 Through-beam sensors</b>																
	-	-	M12 x 60	T	15° 6°	-				-	IP 67, IP 68, IP 69K	Stainless steel V2A		PVC, 5 m		OSP 12 VLF-5M OSP 12 VHFL-5M
	1	5	M12 x 60	E	Push-pull 200 mA	■				500	IP 67, IP 68, IP 69K	Stainless steel V2A		PVC, 5 m		OEP 12 V 5000 G1L-5M OEP 12 V 5000 G2L-5M
	6	20				■			150	OEP 12 V 20000 G1L-5M OEP 12 V 20000 G2L-5M						
	20	50				■		■	20	OEP 12 V 50000 G1L-5M OEP 12 V 50000 G2L-5M						
	-	-	M12 x 75	T	15° 6°	-				-	IP 67, IP 68, IP 69K	Stainless steel V2A		M12 VK ...		OSP 12 VLF-IBSL OSP 12 VHF-IBSL
	1	5	M12 x 75	E	Push-pull 200 mA	■				500	IP 67, IP 68, IP 69K	Stainless steel V2A		M12 VK ...		OEP 12 V 5000 G1-IBSL OEP 12 V 5000 G2-IBSL
	6	20				■		■	150	OEP 12 V 20000 G1-IBSL OEP 12 V 20000 G2-IBSL						
	20	50				■		■	20	OEP 12 V 50000 G1-IBSL OEP 12 V 50000 G2-IBSL						

## OP-Q12

The rectangular 12 x12 model consists of a transmitter and receiver in a compact design with a low installation depth. Thanks to the robust metal housing, the systems are resistant to vibrations and shaking and therefore do not have to be continually readjusted.



Technical data (typ.)	+20°C, 24 VDC
Emitted light	Infrared light, clocked
Service voltage	10 to 35V DC
Ambient temperature	-20 to +60°C

	Range (opening angle 15°) when operating with OSP 12 MLF ... / OSPQ 12 MLF ... (m)	Operating distance (opening angle 6°) When operating with OSP 12 VHF ... / OSPQ 12 MHFL ... (m)	Housing design Size (mm)	Transmitter (T) / Receiver (R)	Dispersion angle / opening angle	Switching output	NC (nnp) / NO (nnp)	NO (nnp) / NC (nnp)	NO/NC	Switching frequency (Hz)	Protection type	Housing material	integrated heating function	Cable material/length, Plug connector	Connection cable (optionally available)	Product description
<b>OP-Q12 Through-beam sensors</b>																
	-	-	12 x 12 x 82	T	15° 6°	-				-	IP 67	Aluminum, anodized		PVC, 5 m		OSPQ 12 MLFL-5M OSPQ 12 MHFL-5M
	1	5	12 x 12 x 82	E	Push-pull 200 mA	■				500	IP 67	Aluminum, anodized		PVC, 5 m		OEPQ 12 M 5000 G1L-5M OEPQ 12 M 5000 G2L-5M
	6	20				■			150	OEPQ 12 M 20000 G1-5M OEPQ 12 M 20000 G2L-5M						
	20	50				■			20	OEPQ 12 M 50000 G1L-5M OEPQ 12 M 50000 G2L-5M						
						■										
						■										
	-	-	12 x 12 x 82	T	15° 6°	-				-	IP 67	Aluminum, anodized		M8	TK ...	OSPQ 12 MLF-TSSL OSPQ 12 MHF-TSSL
	1	5	12 x 12 x 82	E	Push-pull 200 mA	■				500	IP 67	Aluminum, anodized		M8	TK ...	OEPQ 12 M 5000 G1-TSSL OEPQ 12 M 5000 G2-TSSL
	6	20				■			150	OEPQ 12 M 20000 G1-TSSL OEPQ 12 M 20000 G2-TSSL						
	20	50				■			20	OEPQ 12 M 50000 G1-TSSL OEPQ 12 M 50000 G2-TSSL						
						■										
						■										

## OP-50

The high-performance light barriers in the OP-50 series have a robust metallic housing. The systems in rectangular design have special functions such as a switchable reflected beam angle, adjustable transmitting power and variants with a heating function.

Technical data (typ.)	+20°C, 24 VDC
Emitted light	Infrared light, clocked
Service voltage	10 to 35V DC
Ambient temperature	-10to+60°C
	-40to+50°C (.../H)



OP-50 Through-beam sensors															
	Range (opening angle 15°) when operating with OSP 12 MLFL ... / OSPQ 12 MLFL ... (m)	Operating distance (opening angle 6°) When operating with OSP 12 VHF ... / OSPQ 12 MHFL ... (m)	Housing design Size (mm)	Transmitter (T) / Receiver (R)	Dispersion angle / opening angle	Switching output	NC (npn) / NO (npn)	NO (pnp) / NC (pnp)	NO/NC	Switching frequency (Hz)	Protection type	Housing material	integrated heating function	Product description	
	50	50	50 x 40 x 15	T	-				-	IP 67	Die-cast zinc		M12	VK ...	OSP 50 M 50000-IBS
				E	Push-pull, 200 mA		■		20						OEVP 50 M 50000 G3LK-IBS
	50	50	50 x 40 x 15	T	-				-	IP 67	Die-cast zinc	■	M12	VK ...	OSP 50 M 50000-IBS/H
				E	Push-pull 200 mA		■		20						OEVP 50 M 50000 G3LK-IBS/H

## Plastic fiber-optic sensors



Our plastic fiber optic sensors are used wherever small objects must be detected and mounting space is limited. Through a range of modular fiber optics and accessories, they can be adapted to the respective application. For tophat rail mounting, the fiber-optic amplifiers can be arranged in series as desired.



 **di-soric**

OLV-K Amplifier

93

KL plastic fiber-optics

94

## OLV-K AMPLIFIER

di-soric fiber optic amplifiers can be easily operated and simultaneously offer maximum control. The very high-performance and efficient amplifiers stand out for their very long ranges, time functions and simple operation. Alternatively, amplifiers with two digital LED displays or potentiometers are available.



Technical data (typ.)	+20°C, 24 VDC	
	OLVK 61 ...	OLK 71 ...
Emitted light	Red light, clocked	Red light, clocked
Switching output	Transistor, 200 mA, NO/NC, switchable	100 mA, NO/NC, programmable
Ambient temperature	-25 to +55 °C	-10 to +55 °C
Protection type	IP 64	IP 54
Housing material	PBTP (Crastin)	ABS / PC

	Housing design Size (mm)	Sensitivity adjustment by means of	Service voltage (V)	Activation time (ms)	Polarity	Digital LED display	Switching hysteresis (%)	Temperature drift (%/K)	No-load current (mA)	Plug connector	Connection cable (optionally available)	Product description
<b>OLV-K amplifiers for glass fiber optic cables</b>												
	60 x 31 x 10	Potentiometer	10 to 30	0.33	pnp	10	0.2	15	M8	TK ...		OLVK 61 P3K-TSSL/3
					pnp	10	0.2					TK ... /4
	69 x 33 x 10.5	Teach	12 to 24	0.25 to 1.25	pnp	■			40	M8	TK ... /4	OLK 71 P3-T4
					nnp	■						OLK 71 N3-T4
	69 x 33 x 10.5	Teach	12 to 24	0.25 to 1.25	pnp	■			40		Cable 2.0 m	OLK 71 P3-3
					nnp	■						OLK 71 N3-3

### Operating distance specifications for plastic fiber-optic cables

The maximum operating distance specification for fiber-optic cables refers to measurements using the reference amplifier OLV 71 ... with a light intensity of 200% and a standard target of 100x100mm, white. When using another amplifier or a different amplifier setting, determine the expected range based on the calculation factor.

Fiber-optic amplifier	Calculation factor compared to the reference amplifier OLV 71 ... <sup>1)</sup> (typ.)	
<b>OLK 71 ... <sup>1)</sup></b>	<b>100%</b>	
OLVK 61 P3K-TSSL/3	100%	
OLVK 61 P3FK-TSSL	100%	

Light intensity	Range factor <sup>1)</sup>	Activation time
200%	100%	1.25 ms
100%	75%	0.63 ms
50%	70%	0.42 ms
25%	40%	0.31 ms
12%	25%	0.25 ms

<sup>1)</sup> OLV71 ... with light intensity 12 to 200%

Lichtstaster	Tastkopf (Größe/Material) (Sensor probe Size / Material)	Faser (Fibre)	Reichweite <sup>1)</sup> (mm) (Operating range <sup>1)</sup> (mm)	Auflösung <sup>1)</sup> (mm) (Resolution <sup>1)</sup> (mm)	Produktbezeichnung (Product-ID)
	M6 Edelstahl (Stainless steel)	Parallel 1,0mm (2x)	200	Ø0,1	KLT-M6-T2-1
	Große Reichweite		Long operating range		
	M6 Edelstahl (Stainless steel)	Koaxial 1,0mm (1x) 0,25mm (1x)	250	Ø0,05	KLT-M6-T2-1K
	Große Reichweite Kleinteilerkennung		Long operating range Small parts detection		
	M4 Edelstahl (Stainless steel)	Parallel 0,5mm (2x)	75	Ø0,05	KLT-M4-T2-0.5
	Genaue Erkennung Optionale Vorsatzoptik		Precise detection Optional attachment optics		
	M4 Edelstahl (Stainless steel)	Koaxial 0,5mm (1x) 0,25mm (1x)	100	Ø0,05	KLT-M4-T2-0.5K
	Kleinteilerkennung Optionale Vorsatzoptik		Small parts detection Optional attachment optics		

## KL PLASTIC FIBER-OPTICS

di-soric offers a wide range of fiber optic products with accessories. The portfolio includes, among others, sensor probes made of stainless steel with bend protection, sensor probes with light bands for range monitoring and fiber optics for detection of the smallest parts.

<b>Technical data (typ.)</b>	<b>+20 °C, 24 VDC</b>
For more information, visit	<a href="http://www.di-soric.com">www.di-soric.com</a>



Order information	
Axial light aperture	Optional attachment optics
Radial light aperture	Coaxial fiber arrangement
Flexible sensor probe	Ambient temperature
Area detection	Length of the fiber-optic cable
Fixed-focus detection	Cable grommet
	Minimum permitted bending radius of the fiber-optic cable
	Fiber-optic cable can be cut to size, cutting knife included
	Fiber-optic cable cannot be cut to size
	Integrated optics

	Sensor probe (size / material)	Fiber	Operating distance (mm)	Resolution (mm)	Product description
<p><b>KL plastic fiber-optic cable light sensor</b></p>	M6 Stainless steel	Parallel 0.5 mm (2x)	400 <sup>1)</sup>	Ø 0,3 <sup>2)</sup>	
	M6 Stainless steel	Parallel 0.5 mm (2x)	20 <sup>1)</sup>	Ø 0,05 <sup>2)</sup>	
	M6 Stainless steel	Parallel 0.5 mm (2x)	35 <sup>1)</sup>	Ø 0,1 <sup>2)</sup>	
	Integrated optics for a narrow light beam Long range				<b>KLT-M6-T2-1.5NB</b>
	Integrated optics for focusing Small parts detection				<b>KLT-M6-T2-0.5-L20</b>
	Integrated optics for focusing Small parts detection				<b>KLT-M6-T2-0.5-L35</b>

**1** Cable protective casing

<sup>1)</sup> Maximum values (typ.) for a standard target 100 x 100 mm, white.











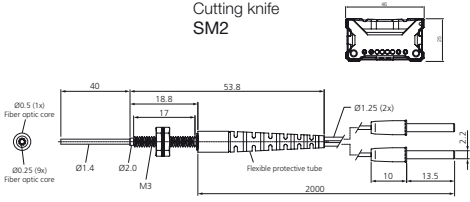

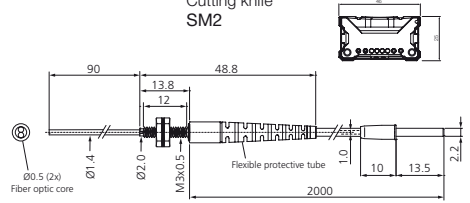

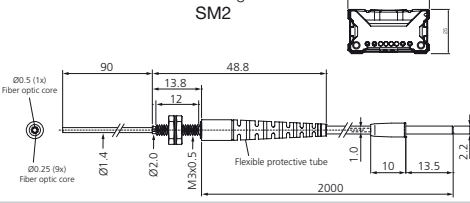
<sup>2)</sup> Resolution (typ.) for optimal settings and measuring distances (sensor approx. 5 mm, one-way: approx. 100 mm).

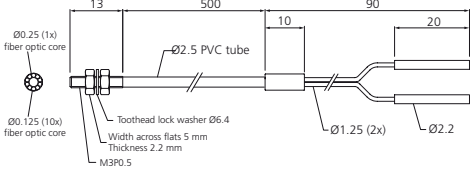

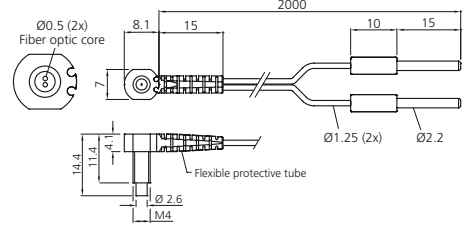
	Sensor probe (size / material)	Fiber	Operating distance (mm)	Resolution (mm)	Product description
<b>KL plastic fiber-optic cable light sensor</b>					
	M6 Stainless steel	Parallel 1.0 mm (2x)	200 <sup>1)</sup>	Ø0,1 <sup>2)</sup>	
Large operating distance					<b>KLT-M6-T2-1</b>
	M6 Stainless steel	Coaxial 1.0 mm (1x) 0.25 mm (16x)	250 <sup>1)</sup>	Ø0,05 <sup>2)</sup>	
Large operating distance Small parts detection					<b>KLT-M6-T2-1K</b>
	M4 Stainless steel	Parallel 0.5 mm (2x)	75 <sup>1)</sup>	Ø0,05 <sup>2)</sup>	
Accurate detection Optional attachment optics					<b>KLT-M4-T2-0.5</b>
	M4 Stainless steel	Coaxial 0.5 mm (1x) 0.25 mm (9x)	100 <sup>1)</sup>	Ø0,05 <sup>2)</sup>	
Small parts detection Optional attachment optics					<b>KLT-M4-T2-0.5K</b>
	M3 Stainless steel	Parallel 0.5 mm (2x)	75 <sup>1)</sup>	Ø0,05 <sup>2)</sup>	
Accurate detection Optional attachment optics					<b>KLT-M3-T2-0.5</b>
	M3 Stainless steel	Coaxial 0.5 mm (1x) 0.25 mm (9x)	100 <sup>1)</sup>	Ø0,05 <sup>2)</sup>	
Small parts detection Optional attachment optics					<b>KLT-M3-T2-0.5K</b>
	M3 / Ø1.4 Stainless steel	Parallel 0.5 mm (2x)	75 <sup>1)</sup>	Ø0,1 <sup>2)</sup>	
Flexible sensor probe / R min. > 10mm Accurate detection					<b>KLT-M3-B40-T2-0.5</b>

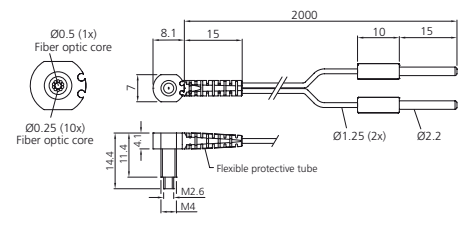

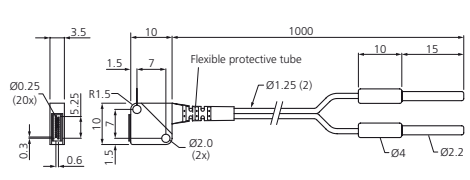





<sup>1)</sup> Maximum values (typ.) for a standard target 100 x 100 mm, white.

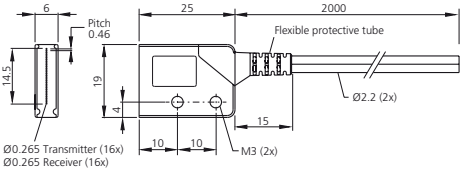

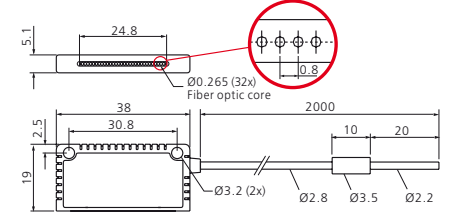

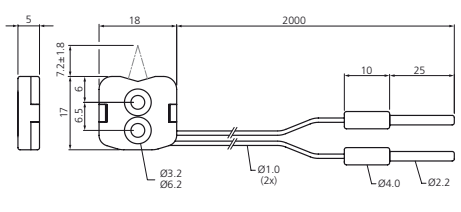

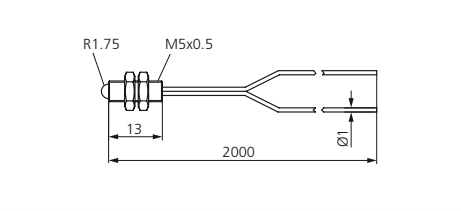

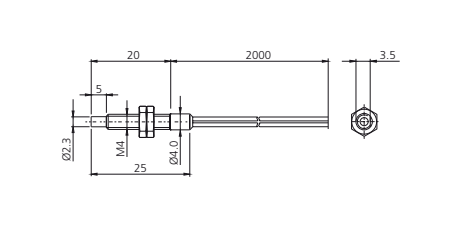
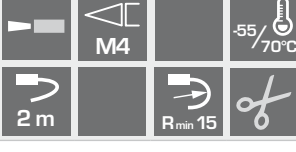
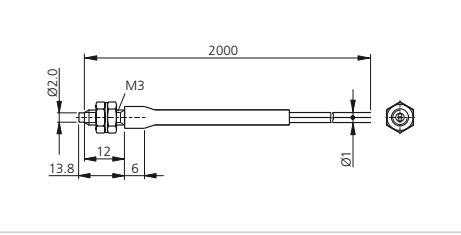
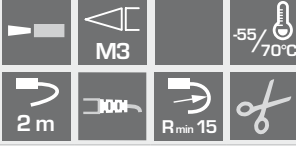
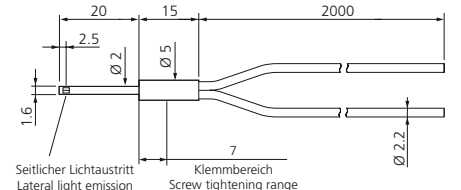
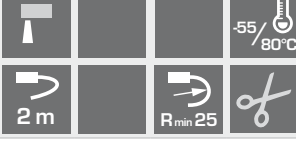

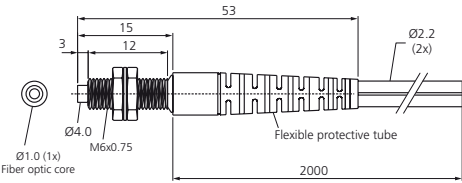





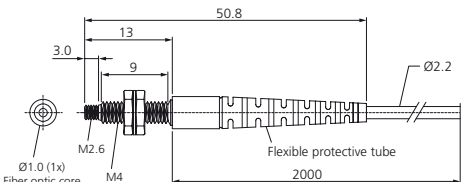





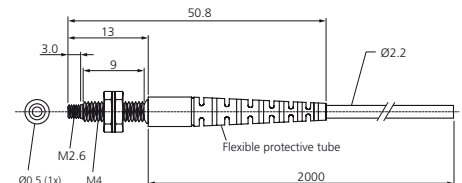





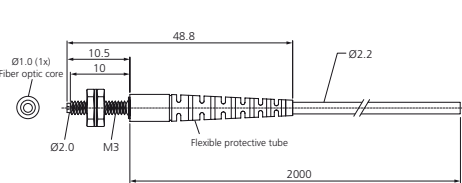





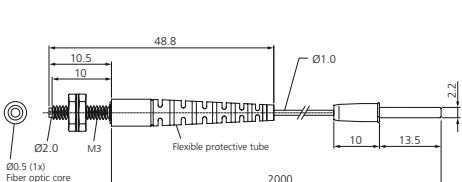

<sup>2)</sup> Resolution (typ.) for optimal settings and measuring distances (sensor approx. 5mm, one-way: approx. 100 mm).

	Sensor probe (size / material)	Fiber	Operating distance (mm)	Resolution (mm)	Product description
<b>KL plastic fiber-optic cable light sensor</b>					
	M3 / Ø1.4 Stainless steel	Coaxial 0.5 mm (1x) 0.25 mm (9x)	100 <sup>1)</sup>	Ø0,05 <sup>2)</sup>	
Flexible sensor probe / R min. > 10 mm Small parts detection					<b>KLTM-M3-B40-T2-0.5K</b>
	M3 / Ø1.4 Stainless steel	Parallel 0.5 mm (1x)	75 <sup>1)</sup>	Ø0,1 <sup>2)</sup>	
Flexible sensor probe / R min. > 10 mm Accurate detection					<b>KLTR-M3-B90-T2-0.5</b>
	M3 / Ø1.4 Stainless steel	Coaxial 0.5 mm (1x) 0.25 mm (9x)	100 <sup>1)</sup>	Ø0,05 <sup>2)</sup>	
Flexible sensor probe / R min. > 10 mm Small parts detection					<b>KLTM-M3-B90-T2-0.5K</b>
	M3 Stainless steel	Coaxial Ø0.25 (1x) Ø0.125 (10x)	40 <sup>1)</sup>	Ø0.02 <sup>2)</sup>	
Highly accurate detection Optional attachment optics					<b>KLTM-M3-S0.5-0.25K</b>
	M4 Stainless steel	Parallel 0.5 mm (2x)	60 <sup>1)</sup>	Ø0,1 <sup>2)</sup>	
Low installation depth 90° deflection Accurate detection Optional attachment optics					<b>KLTR-M4-T2-0.5</b>
	M4 Stainless steel	Coaxial 0.5 mm (1x) 0.25 mm (10x)	90 <sup>1)</sup>	Ø0,05 <sup>2)</sup>	
Low installation depth 90° deflection Small parts detection Optional attachment optics					<b>KLTR-M4-T2-0.5K</b>
	10 x 10 x 3.5 mm Stainless steel	5.25 mm Transmitter 0.265 mm (16x) Receiver	100 <sup>1)</sup>	Ø0,1 <sup>2)</sup>	
Area detection without gaps Accurate detection					<b>KLTM-Q10-T1-5</b>

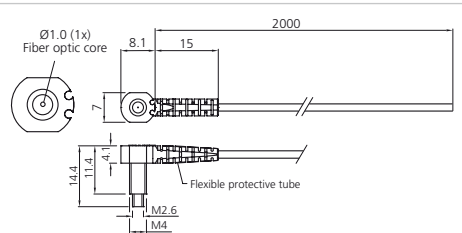
<sup>1)</sup> Maximum values (typ.) for a standard target 100 x 100 mm, white.









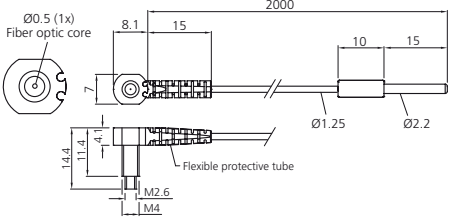

<sup>2)</sup> Resolution (typ.) for optimal settings and measuring distances (sensor approx. 5 mm, one-way: approx. 100 mm).

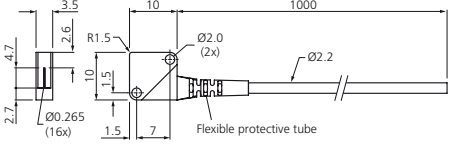
	Sensor probe (size / material)	Fiber	Operating distance (mm)	Resolution (mm)	Product description
<b>KL plastic fiber-optic cable light sensor</b> 					
 <p>Ø0.265 Transmitter (16x) Ø0.265 Receiver (16x)</p>	19 x 25 x 6 mm Plastic	14.5 mm Transmitter 0.265 mm (16x) Receiver 0.265 mm (16x)	240 <sup>1)</sup>	Ø0,5 <sup>2)</sup>	
Area detection Large operating distance <b>KLTM-Q25K-T1-14</b>					
 <p>Ø0.265 (32x) Fiber optic core</p>	38 x 19 x 5 mm Plastic	24.8 mm Transmitter 0.265 mm (32x) Receiver	200 <sup>1)</sup>	Ø1,0 <sup>2)</sup>	
Area detection 90° deflection Large operating distance <b>KLTM-R-Q38K-1-24</b>					
 <p>Ø3.2 Ø6.2 Ø1.0 (2x) Ø4.0 Ø2.2</p>	18 x 17 x 5 mm Plastic	A: 7.2 mm parallel Ø0.5 (2x)	5 to 10 <sup>1)</sup>	Ø0,1 <sup>2)</sup>	
Fixed-focus detection 90° deflection Low installation depth <b>KLTVR-Q18-2-10</b>					
 <p>R1.75 M5x0.5 Ø1 2000</p>	M5 Edelstahl	0.5 mm	200 <sup>1)</sup>	Ø0,1 <sup>2)</sup>	
Ball-shaped optics for cylindrical beam Ø 8 mm <b>WRBT 2000 K-M5-Z8</b>					
 <p>Ø2.3 M4 Ø4.0 20 25 3.5</p>	M4 Stainless steel	Parallel 0.5 mm (2x)	75 <sup>1)</sup>	Ø0,05 <sup>2)</sup>	
Accurate detection Optional attachment optics <b>WRBT 2000 K-M4-1.0</b>					
 <p>Ø2.0 M3 12 6 2000 Ø1</p>	M3 Stainless steel	Parallel 0.5 mm (2x)	75 <sup>1)</sup>	Ø0,05 <sup>2)</sup>	
Accurate detection Optional attachment optics <b>WRBT 2000 K-M3-0.5</b>					
 <p>Seitlicher Lichtaustritt Lateral light emission Klemmbereich Screw tightening range Ø 2.2</p>	Ø5 Stainless steel	Ø 0.8 mm	100 <sup>1)</sup>	Ø0,2 <sup>2)</sup>	
Low installation depth Small sensor probe <b>WRBT 2000 KR-5.0-2.0</b>					

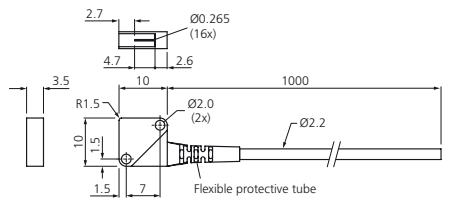
	Sensor probe (size/material)	Fiber	Operating distance (mm)	Resolution (mm)	Product description
<b>KL plastic fiber-optic cable through-beam sensor</b> 					
	M6 Stainless steel	1.0mm	1,000 <sup>1)</sup>	Ø0,2 <sup>2)</sup>	    
	Large operating distance				<b>KLE-M6-T2-1</b>
	M6 Stainless steel	1.0mm	1,000 <sup>1)</sup>	Ø0,2 <sup>2)</sup>	    
	Large operating distance				<b>KLE-M4-T2-1</b>
	M4 Stainless steel	0.5mm	250 <sup>1)</sup>	Ø0,1 <sup>2)</sup>	     
	Accurate detection Optional attachment optics				<b>KLE-M4-T2-0.5</b>
	M3 Stainless steel	1.0mm	1,000 <sup>1)</sup>	Ø0,2 <sup>2)</sup>	    
	Large operating distance				<b>KLE-M3-T2-1</b>
	M3 Stainless steel	0.5mm	250 <sup>1)</sup>	Ø0,1 <sup>2)</sup>	    
	Accurate detection				<b>KLE-M3-T2-0.5</b>
	M4 Stainless steel	1.0mm	400 <sup>1)</sup>	Ø0,2 <sup>2)</sup>	     
	Low installation depth 90° deflection Large operating distance Optional attachment optics				<b>KLER-M4-T2-1</b>

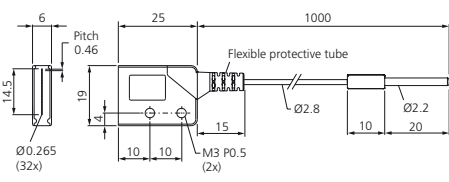
<sup>1)</sup>Maximum values (typ.) for a standard target 100 x 100 mm, white.

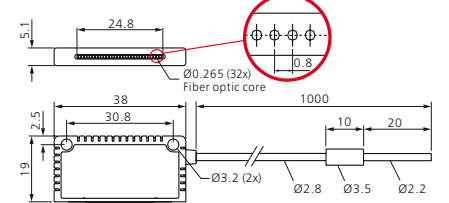
<sup>2)</sup>Resolution (typ.) for optimal settings and measuring distances (sensor approx. 5 mm, one-way: approx. 100 mm).

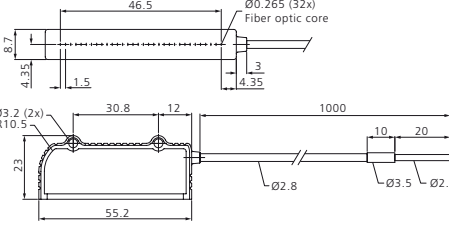
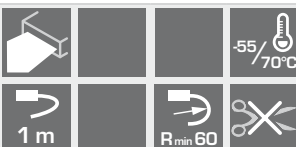
	Sensor probe (size / material)	Fiber	Operating distance (mm)	Resolution (mm)	Product description
<b>KL plastic fiber-optic cable through-beam sensor</b> 					
	M4 Stainless steel	0.5 mm	200 <sup>1)</sup>	Ø0,1 <sup>2)</sup>	
Low installation depth 90° deflection Accurate detection Optional attachment optics					<b>KLER-M4-T2-0.5</b>
	10 x 10 x 3.5 mm Stainless steel	4.24 mm 0.265 mm (16x)	200 <sup>1)</sup>	Ø0,1 <sup>2)</sup>	
Area detection without gaps Large operating distance Accurate detection					<b>KLEM-Q10-T1-4</b>
	10 x 10 x 3.5 mm Stainless steel	4.24 mm 0.265 mm (16x)	200 <sup>1)</sup>	Ø0,1 <sup>2)</sup>	
Area detection without gaps 90° deflection Large operating distance Accurate detection					<b>KLEMR-Q10-T1-4</b>
	19 x 25 x 6 mm Plastic	14.5 mm 0.265 (32x)	1,000 <sup>1)</sup>	Ø0,5 <sup>2)</sup>	
Area detection Large operating distance					<b>KLEM-Q25K-T1-14</b>
	38 x 19 x 5 mm Plastic	24.8 mm 0.265 (32x)	800 <sup>1)</sup>	Ø1,0 <sup>2)</sup>	
Area detection 90° deflection Large operating distance					<b>KLEMR-Q38K-1-24</b>
	55 x 23 x 9 mm Plastic	46.5 mm 0.265 (32x)	800 <sup>1)</sup>	Ø2,0 <sup>2)</sup>	
Area detection 90° deflection Large operating distance					<b>KLEMR-Q55K-1-46</b>

<sup>1)</sup>Maximum values (typ.) for a standard target 100 x 100 mm, white.

<sup>2)</sup>Resolution (typ.) for optimal settings and measuring distances (sensor approx. 5mm, one-way: approx. 100 mm).

	Sensor probe (size/material)	Fiber	Operating distance (mm)	Resolution (mm)	Product description
<b>KL plastic fiber-optic cable through-beam sensor</b>					
	Ø 2.98 mm Stainless steel	1.0 mm	600 <sup>1)</sup>	Ø0,2 <sup>2)</sup>	-55/70°C 2 m R <sub>min</sub> 25
	Low installation depth 90° deflection Large operating distance				<b>KLER-D3-30-S2-1</b>
	Ø 4.75 mm Stainless steel	Ø0.5 mm	200 <sup>1)</sup>	Ø0,05 <sup>2)</sup>	-55/70°C 2 m R <sub>min</sub> 1
	Low installation depth 90° deflection Highly accurate object detection				<b>KLER-D4.75-19-S2-0.5</b>
	10 x 10 x 3 mm Metal	Ø0.5 mm	200 <sup>1)</sup>	Ø0,05 <sup>2)</sup>	40/70°C 1 m R <sub>min</sub> 1
	Accurate detection Flat design				<b>KLE-Q10M-1-0.5</b>
	M6 Brass	Ø 1.0 mm	1,200 <sup>1)</sup>	Ø0,2 <sup>2)</sup>	-25/70°C 2 m R <sub>min</sub> 25
	Low installation depth Large operating distance				<b>WRBE 2000 KR-M6-1.0</b>
<b>Accessories for plastic fiber-optic cables</b>					
		"KLS-Z Plastic fiber-optic sensor accessories" on page 226			

<sup>1)</sup> Maximum values (typ.) for a standard target 100 x 100 mm, white.

<sup>2)</sup> Resolution (typ.) for optimal settings and measuring distances (sensor approx. 5 mm, one-way: approx. 100 mm).



## Glass fiber-optic sensors

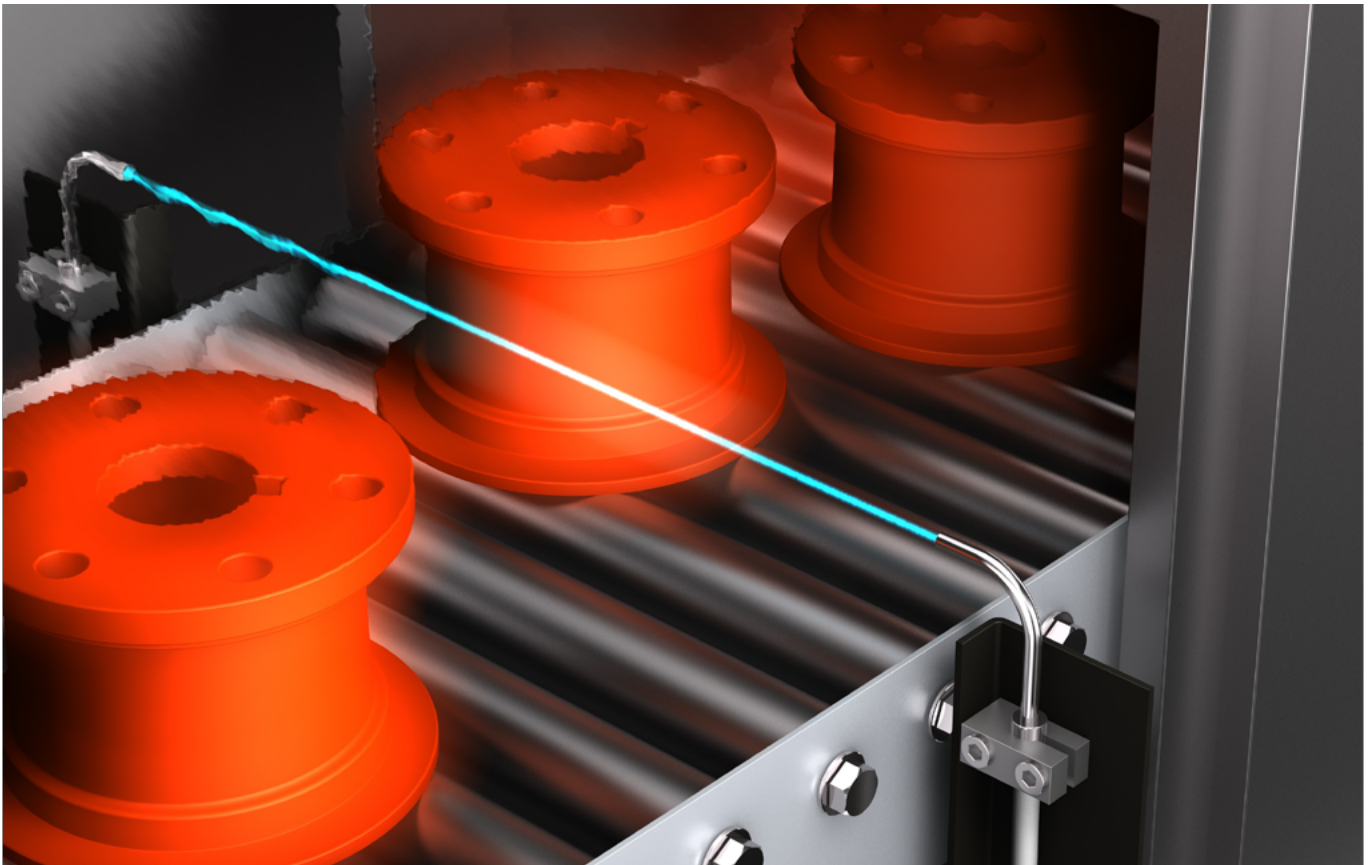

Challenging applications with little installation space are the area of application of the fiber optic sensors from di-soric. The robust devices stand the test with oil just as reliably as with high mechanical loads and at high temperatures. Their large range is another important advantage.

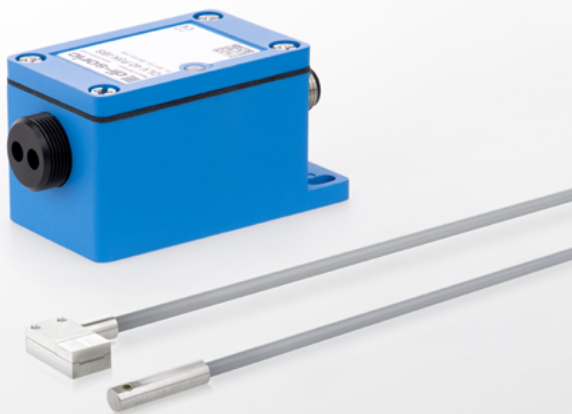

 **di-soric**

OLV-G Amplifier

103

WRB Glass fiber optics

103



## OLV-G AMPLIFIER

Thanks to their stable metallic housing and the high protection class, the amplifiers in the OLV-G series are - ideal for handling challenging individual applications. The devices are operated through simple auto-teach.



Technical data (typ.)	+20 °C, 24 VDC
Switching output	Transistor, pnp, 200 mA, NO/NC, switchable
Ambient temperature	-10 to +60 °C
Housing material	Die-cast zinc
Protection type	IP 65

	Housing design Size (mm)	Sensitivity adjustment by means of	Service voltage (V)	Switching frequency (kHz)	Infrared light, clocked	Red light, clocked	Green light, clocked	Switching hysteresis (%)	Temperature drift (%/K)	Ambient light immunity (kLx)	No-load current (mA)	Plug connector	Connection cable (optionally available)	Product description	
<b>OLV-G amplifiers for glass fiber optic cables</b>															
	40 x 41 x 75	Potentiometer	12 to 35	1.5	■			10	0.3	20	55	M12	VK ... /4	OLV 40 P3K-IBS	
				1.5		■									OLV 41 P3K-IBS
				0.5			■								
	40 x 41 x 75	Potentiometer	12 to 35	1.5	■			10	0.3	20	55	Clamps		OLV 40 P4K	
						■									OLV 41 P4K
	40 x 41 x 75	Teach	10 to 35	1.5	■			12	0.1	50	45	M12	VK ... /4	OLVTI 40 P3K-IBS	
									0.25						

## WRB GLASS FIBER OPTICS

Our product portfolio of fiber optics includes high-quality fibers for large ranges, a high mechanical load and high temperatures.



Technical data (typ.)	+20 °C, 24 VDC
Housing material	V2A
	Aluminum (...SQ.../...MQ.../WRB 220 SW)
Single fiber	50 µm
Opening angle	67°
Temperature resistance	-40 to +180 °C, for short periods up to +250 °C (silicone-metal sleeve)
	-40 to +180 °C, for short periods up to +300 °C (metal sleeve)

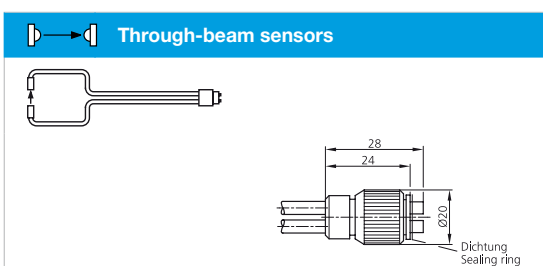
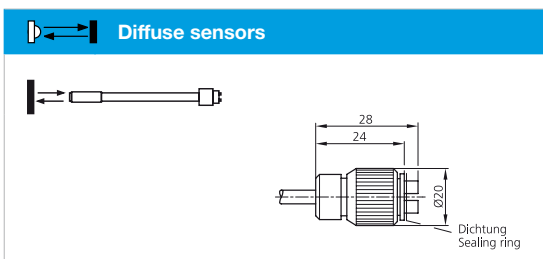

**Installation instructions for glass fiber-optic cables**

- For permanently installed fiber optic cables.
- All specified scan widths and ranges are average values associated with the fiber-optic amplifier in infrared light. If necessary, adjust the sensitivity range using the basic sensitivity potentiometer P2. The specified scan widths and ranges are reduced to about 80% in red light and to about 30% in green light. The values also depend on the fiber-optic cable and on the object being scanned (size, shape, surface, color, etc.).
- With attachment optics and axial light aperture. Only possible for fiber-optic cables of corresponding length.

	Fiber bundle	Scan width <sup>2)</sup> (mm)	Cable jacket	Cable length (mm)	Bending radius	Protection type	Product description
<b>WRB glass fiber-optic cable light sensor</b>							
	Ø1.0	up to 20	Silicone metal sleeve	300 600 1,000	> 3x tube Ø	IP 67	WRB 110 S-1.5-1.0 WRB 120 S-1.5-1.0 WRB 130 S-1.5-1.0
	Ø1.0	up to 20	metal sleeve	300 600 1,000	> 10x tube Ø	IP 60	WRB 110 M-1.5-1.0 WRB 120 M-1.5-1.0 WRB 130 M-1.5-1.0
	Ø1.0	up to 15	Silicone metal sleeve	300 600 1,000	> 3x tube Ø	IP 67	WRB 110 S-90-1.5-1.0 WRB 120 S-90-1.5-1.0 WRB 130 S-90-1.5-1.0
	Ø1.0	up to 15	metal sleeve	300 600 1,000	> 10x tube Ø	IP 60	WRB 110 M-90-1.5-1.0 WRB 120 M-90-1.5-1.0 WRB 130 M-90-1.5-1.0
<p>biegsamer Bereich, min. Radius 6 mm bendable area, min. radius 6 mm</p>	Ø1.0	up to 20	Silicone metal sleeve	300 600 1,000	> 3x tube Ø	IP 67	WRB 110 SB-2.0-1.0 WRB 120 SB-2.0-1.0 WRB 130 SB-2.0-1.0
	Ø1.0	up to 20	metal sleeve	300 600 1,000	> 10x tube Ø	IP 60	WRB 110 MB-2.0-1.0 WRB 120 MB-2.0-1.0 WRB 130 MB-2.0-1.0
	Ø1.5	up to 30	Silicone metal sleeve	300 600 1,000	> 3x tube Ø	IP 67	WRB 110 S-M2.5-1.5 WRB 120 S-M2.5-1.5 WRB 130 S-M2.5-1.5
	Ø1.5	up to 30	metal sleeve	300 600 1,000	> 10x tube Ø	IP 60	WRB 110 M-M2.5-1.5 WRB 120 M-M2.5-1.5 WRB 130 M-M2.5-1.5
	Ø2.5	up to 85	Silicone metal sleeve	300 600 1,000	> 3x tube Ø	IP 67	WRB 110 S-M4-2.5 WRB 120 S-M4-2.5 WRB 130 S-M4-2.5
	Ø2.5	up to 85	metal sleeve	300 600 1,000	> 10x tube Ø	IP 60	WRB 110 M-M4-2.5 WRB 120 M-M4-2.5 WRB 130 M-M4-2.5
	Ø2.5	up to 85	Silicone metal sleeve	300 600 1,000	> 3x tube Ø	IP 67	WRB 110 S-M6-2.5 WRB 120 S-M6-2.5 WRB 130 S-M6-2.5
	Ø2.5	up to 85	metal sleeve	300 600 1,000	> 10x tube Ø	IP 60	WRB 110 M-M6-2.5 WRB 120 M-M6-2.5 WRB 130 M-M6-2.5
	Ø2.5	up to 85	Polyurethane metal sleeve	300 600 1,000	> 5x tube Ø	IP 67	WRB 110 P-5.6-2.5 WRB 120 P-5.6-2.5 WRB 130 P-5.6-2.5
	Ø2.5	up to 85	Silicone metal sleeve	300 600 1,000	> 3x tube Ø	IP 67	WRB 110 S-8.0-2.5 WRB 120 S-8.0-2.5 WRB 130 S-8.0-2.5
	Ø2.5	up to 85	metal sleeve	300 600 1,000	> 10x tube Ø	IP 60	WRB 110 M-8.0-2.5 WRB 120 M-8.0-2.5 WRB 130 M-8.0-2.5

	Fiber bundle	Scan width <sup>(1)</sup> (mm)	Cable jacket	Cable length (mm)	Bending radius	Protection type	Product description
<b>WRB glass fiber-optic cable light sensor</b>							
	Ø4.0	up to 150	Silicone metal sleeve	300 600 1,000	>3x tube Ø	IP 67	WRB 110 S-8.5-4.0 WRB 120 S-8.5-4.0 WRB 130 S-8.5-4.0
	Ø4.0	up to 150	metal sleeve	300 600 1,000	>10x tube Ø	IP 60	WRB 110 M-8.5-4.0 WRB 120 M-8.5-4.0 WRB 130 M-8.5-4.0
	Ø2.5	up to 80	Silicone metal sleeve	300 600 1,000	>3x tube Ø	IP 67	WRB 110 S-90-4.0-2.5 WRB 120 S-90-4.0-2.5 WRB 130 S-90-4.0-2.5
	Ø2.5	up to 80	metal sleeve	300 600 1,000	>10x tube Ø	IP 60	WRB 110 M-90-4.0-2.5 WRB 120 M-90-4.0-2.5 WRB 130 M-90-4.0-2.5
	Ø2.5	up to 70	Silicone metal sleeve	300 600 1,000	>3x tube Ø	IP 67	WRB 110 SR-8.0-2.5 WRB 120 SR-8.0-2.5 WRB 130 SR-8.0-2.5
	Ø2.5	up to 70	metal sleeve	300 600 1,000	>10x tube Ø	IP 60	WRB 110 MR-8.0-2.5 WRB 120 MR-8.0-2.5 WRB 130 MR-8.0-2.5
	Ø0.6 (10x) Ø0.3 (10x)	up to 90	Silicone metal sleeve	300 600 1,000	>3x tube Ø	IP 67	WRB 110 SQ-10-0.6 WRB 120 SQ-10-0.6 WRB 130 SQ-10-0.6
	Ø0.6 (10x) Ø0.3 (10x)	up to 90	metal sleeve	300 600 1,000	>10x tube Ø	IP 60	WRB 110 MQ-10-0.6 WRB 120 MQ-10-0.6 WRB 130 MQ-10-0.6
	Ø0.6 (10x) Ø0.3 (10x)	up to 85	Silicone metal sleeve	300 600 1,000	>3x tube Ø	IP 67	WRB 110 SQ-90-10-0.6 WRB 120 SQ-90-10-0.6 WRB 130 SQ-90-10-0.6
	Ø0.6 (10x) Ø0.3 (10x)	up to 85	metal sleeve	300 600 1,000	>10x tube Ø	IP 60	WRB 110 MQ-90-10-0.6 WRB 120 MQ-90-10-0.6 WRB 130 MQ-90-10-0.6
	Ø0.6 (20x) Ø0.3 (20x)	up to 210	Silicone metal sleeve	300 600 1,000	>3x tube Ø	IP 67	WRB 110 SQ-20-0.6 WRB 120 SQ-20-0.6 WRB 130 SQ-20-0.6
	Ø0.6 (20x) Ø0.3 (20x)	up to 210	metal sleeve	300 600 1,000	>10x tube Ø	IP 60	WRB 110 MQ-20-0.6 WRB 120 MQ-20-0.6 WRB 130 MQ-20-0.6
	Ø0.6 (20x) Ø0.3 (20x)	up to 200	Silicone metal sleeve	300 600 1,000	>3x tube Ø	IP 67	WRB 110 SQ-90-20-0.6 WRB 120 SQ-90-20-0.6 WRB 130 SQ-90-20-0.6
	Ø0.6 (20x) Ø0.3 (20x)	up to 200	metal sleeve	300 600 1,000	>10x tube Ø	IP 60	WRB 110 MQ-90-20-0.6 WRB 120 MQ-90-20-0.6 WRB 130 MQ-90-20-0.6
	Ø2.5	10-100	Silicone metal sleeve	600	>3x tube Ø	IP 67	WRB 220 SW

	Fiber bundle	Scan width <sup>2)</sup> (mm)	Cable jacket	Cable length (mm)	Bending radius	Protection type	Product description
	Ø1.0	up to 150	Silicone metal sleeve	300	> 3x <sup>1)</sup> tube Ø	IP 67	WRB 210 S-1.5-1.0
				600			WRB 220 S-1.5-1.0
				1,000			WRB 230 S-1.5-1.0
	Ø1.0	up to 150	metal sleeve	300	> 10x <sup>1)</sup> tube Ø	IP 60	WRB 210 M-1.5-1.0
				600			WRB 220 M-1.5-1.0
				1,000			WRB 230 M-1.5-1.0
	Ø1.0	up to 120	Silicone metal sleeve	300	> 3x <sup>1)</sup> tube Ø	IP 67	WRB 210 S-90-1.5-1.0
				600			WRB 220 S-90-1.5-1.0
				1,000			WRB 230 S-90-1.5-1.0
	Ø1.0	up to 120	metal sleeve	300	> 10x <sup>1)</sup> tube Ø	IP 60	WRB 210 M-90-1.5-1.0
				600			WRB 220 M-90-1.5-1.0
				1,000			WRB 230 M-90-1.5-1.0
<p>biegsamer Bereich, min. Radius 6 mm bendable area, min. radius 6 mm</p>	Ø1.0	up to 150	Silicone metal sleeve	300	> 3x <sup>1)</sup> tube Ø	IP 67	WRB 210 SB-2.0-1.0
				600			WRB 220 SB-2.0-1.0
				1,000			WRB 230 SB-2.0-1.0
	Ø1.0	up to 150	metal sleeve	300	> 10x <sup>1)</sup> tube Ø	IP 60	WRB 210 MB-2.0-1.0
				600			WRB 220 MB-2.0-1.0
				1,000			WRB 230 MB-2.0-1.0
	Ø1.5	up to 250 (500) <sup>3)</sup>	Silicone metal sleeve	300	> 3x <sup>1)</sup> tube Ø	IP 67	WRB 210 S-M2.5-1.5
				600			WRB 220 S-M2.5-1.5
				1,000			WRB 230 S-M2.5-1.5
	Ø1.5	up to 250 (500) <sup>3)</sup>	metal sleeve	300	> 10x <sup>1)</sup> tube Ø	IP 60	WRB 210 M-M2.5-1.5
				600			WRB 220 M-M2.5-1.5
				1,000			WRB 230 M-M2.5-1.5
	Ø2.5	up to 900 (1,800) <sup>3)</sup>	Silicone metal sleeve	300	> 3x <sup>1)</sup> tube Ø	IP 67	WRB 210 S-M4-2.5
				600			WRB 220 S-M4-2.5
				1,000			WRB 230 S-M4-2.5
	Ø2.5	up to 900 (1,800) <sup>3)</sup>	metal sleeve	300	> 10x <sup>1)</sup> tube Ø	IP 60	WRB 210 M-M4-2.5
				600			WRB 220 M-M4-2.5
				1,000			WRB 230 M-M4-2.5
	Ø2.5	up to 900	Silicone metal sleeve	300	> 3x <sup>1)</sup> tube Ø	IP 67	WRB 210 S-M6-2.5
				600			WRB 220 S-M6-2.5
				1,000			WRB 230 S-M6-2.5
	Ø2.5	up to 900	metal sleeve	300	> 10x <sup>1)</sup> tube Ø	IP 60	WRB 210 M-M6-2.5
				600			WRB 220 M-M6-2.5
				1,000			WRB 230 M-M6-2.5
	Ø2.5	up to 85	Polyurethane metal sleeve	300	> 5x <sup>1)</sup> tube Ø	IP 67	WRB 210 P-5.6-2.5
				600			WRB 220 P-5.6-2.5
				1,000			WRB 230 P-5.6-2.5
	Ø2.5	up to 85	Silicone metal sleeve	300	> 3x <sup>1)</sup> tube Ø	IP 67	WRB 210 S-8.0-2.5
				600			WRB 220 S-8.0-2.5
				1,000			WRB 230 S-8.0-2.5
	Ø2.5	up to 85	metal sleeve	300	> 10x <sup>1)</sup> tube Ø	IP 60	WRB 210 M-8.0-2.5
				600			WRB 220 M-8.0-2.5
				1,000			WRB 230 M-8.0-2.5

	Fiber bundle	Scan width <sup>1)</sup> (mm)	Cable jacket	Cable length (mm)	Bending radius	Protection type	Product description
<b>WRB glass fiber-optic cable through-beam sensor</b>							
	Ø4.0	up to 150	Silicone metal sleeve	300	>3x tube Ø	IP 67	WRB 210 S-8.5-4.0
				600			WRB 220 S-8.5-4.0
				1,000			WRB 230 S-8.5-4.0
	Ø4.0	up to 150	metal sleeve	300	>10x tube Ø	IP 60	WRB 210 M-8.5-4.0
				600			WRB 220 M-8.5-4.0
				1,000			WRB 230 M-8.5-4.0
	Ø2.5	up to 900	Silicone metal sleeve	300	>3x tube Ø	IP 67	WRB 210 S-90-4.0-2.5
				600			WRB 220 S-90-4.0-2.5
				1,000			WRB 230 S-90-4.0-2.5
	Ø2.5	up to 900	metal sleeve	300	>10x tube Ø	IP 60	WRB 210 M-90-4.0-2.5
				600			WRB 220 M-90-4.0-2.5
				1,000			WRB 230 M-90-4.0-2.5
	Ø2.5	up to 800	Silicone metal sleeve	300	>3x tube Ø	IP 67	WRB 210 SR-8.0-2.5
				600			WRB 220 SR-8.0-2.5
				1,000			WRB 230 SR-8.0-2.5
	Ø2.5	up to 800	metal sleeve	300	>10x tube Ø	IP 60	WRB 210 MR-8.0-2.5
				600			WRB 220 MR-8.0-2.5
				1,000			WRB 230 MR-8.0-2.5
	Ø0.6 (10x) Ø0.3 (10x)	up to 700	Silicone metal sleeve	300	>3x tube Ø	IP 67	WRB 210 SQ-10-0.3
				600			WRB 220 SQ-10-0.3
				1,000			WRB 230 SQ-10-0.3
	Ø0.6 (10x) Ø0.3 (10x)	up to 700	metal sleeve	300	>10x tube Ø	IP 60	WRB 210 MQ-10-0.3
				600			WRB 220 MQ-10-0.3
				1,000			WRB 230 MQ-10-0.3
	Ø0.6 (10x) Ø0.3 (10x)	up to 650	Silicone metal sleeve	300	>3x tube Ø	IP 67	WRB 210 SQ-90-10-0.3
				600			WRB 220 SQ-90-10-0.3
				1,000			WRB 230 SQ-90-10-0.3
	Ø0.6 (10x) Ø0.3 (10x)	up to 650	metal sleeve	300	>10x tube Ø	IP 60	WRB 210 MQ-90-10-0.3
				600			WRB 220 MQ-90-10-0.3
				1,000			WRB 230 MQ-90-10-0.3
	Ø0.6 (20x) Ø0.3 (20x)	up to 1,200	Silicone metal sleeve	300	>3x tube Ø	IP 67	WRB 210 SQ-20-0.3
				600			WRB 220 SQ-20-0.3
				1,000			WRB 230 SQ-20-0.3
	Ø0.6 (20x) Ø0.3 (20x)	up to 1,200	metal sleeve	600	>10x tube Ø	IP 60	WRB 220 MQ-20-0.3
				1,000			WRB 230 MQ-20-0.3
	Ø0.6 (20x) Ø0.3 (20x)	up to 1,100	Silicone metal sleeve	300	>3x tube Ø	IP 67	WRB 210 SQ-90-20-0.3
				600			WRB 220 SQ-90-20-0.3
				1,000			WRB 230 SQ-90-20-0.3
	Ø0.6 (20x) Ø0.3 (20x)	up to 1,100	metal sleeve	300	>10x tube Ø	IP 60	WRB 210 MQ-90-20-0.3
				600			WRB 220 MQ-90-20-0.3
				1,000			WRB 230 MQ-90-20-0.3

## Color sensors



The di-soric color sensors detect colors and compare them to 100 saved reference color values. Through their perceptive functioning, which is similar to the human eye, small differences can be detected precisely. This makes the use of the devices in the area of quality testing possible - even under industrial ambient conditions.



 **di-soric**

FS-10 Compact	109
FS-50 Extended	109
FS-100 Advanced	109

## FS-10 COMPACT, FS-50 EXTENDED, FS-100 ADVANCED

<b>Technical data (typ.)</b>	<b>+20 °C, 24 VDC</b>
Emitting light source	White-light LED, can be turned off
Color resolution	DE Lab < 1
Protection type	IP 54
	IP 67 (FSB 10...)



	Operating distance (mm)	Measuring channels (number)	Number of color channels (Teach-in via button)	Number of outputs npn + pnp (push-pull)	Service voltage (VDC)	Color memory internal	Operation using software	Operation using buttons	Color channels with binary coding (number)	Fiber-optic cable adapter	Fixed optics	Lighting with aging-compensating white-light LED	Profibus	Ethernet	Product description
<b>FS-10 Compact</b>															
	See fiber-optic cables	1	1	1	10 to 28	1	■		■		■				FSB 10 M G1-B8
<b>FS-50 Extended</b>															
	See fiber-optic cables	1	4	4	18 to 28	100	■	■	15	■		■			FS 12-50 M G3-B8
	30 to 60										■	■			FS 50 M 60 G3-B8
	See fiber-optic cables	1	4	4	18 to 28	4		■		■		■			FSB 50 M G3-B8
	30 to 60										■	■			FSB 50 M 60 G3-B8
<b>FS-100 Advanced</b>															
	See fiber-optic cables	1	12	12	18 to 28	100	■	■	100	■		■			FS 12-100-1 M G8-B8
										■				■	FS 12-100-1 M G8-B8-E
	See fiber-optic cables	2	12	12	18 to 28	100	■	■	100	■					FS 12-100-2 M G8-B8
										■		■	■		FS 12-100-2 M G8-B8-PB
<b>Accessories for color sensors</b>															
	see "FS-Z Color sensor accessories," page 222														

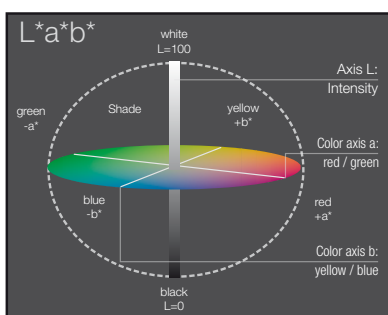

## Contrast sensors

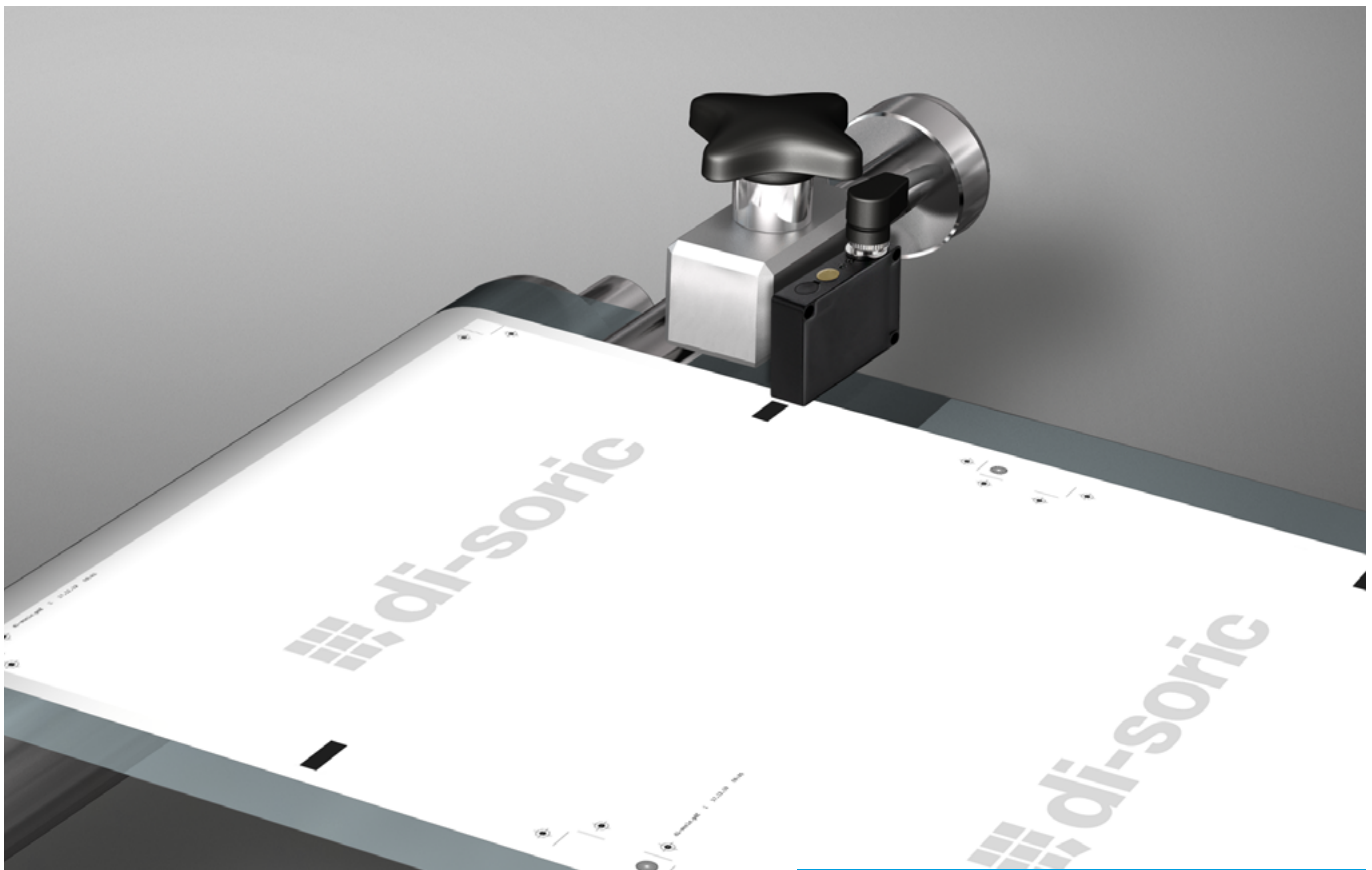

Contrast sensors can detect and compare precise contrasts. The devices are used for reliable, precise detection of printed marks based on color and grayscale contrasts on an extremely wide range of carrier materials such as labels, films, banderoles, cartons or tubes. The devices are configured through intuitive teaching-in.



 **di-soric**

OK-50

111



## OK-50

These contract sensors have a robust metallic housing in rectangular design with a high protection class. The sensors work with white-light (LED) and detect even the finest of contrasts. Their sensitivity can be adjusted in an easy and user-friendly manner with an auto-teach button.



Technical data (typ.)	+20°C, 24 VDC
Service voltage	10 to 35V DC
Switching output	Push-pull, 200 mA, NO/NC switchable
Ambient temperature	-10 to +60°C
Degree of protection	IP 67
Housing material	Die-cast zinc, varnished
Size	50 x 40 x 15 mm (housing dimensions)

OK-50	Scanning range (mm)	Min. teach range (mm)	Transmission light: white, clocked	Resolution (mm)	Sensitivity adjustment by means of	No-load current (mA)	Switching frequency (Hz)	Light spot size (mm)	Plug connector length	Connection cable (optionally available)	Product description
	27 to 33	50	■	Ø 0.7	Teach key, remote teach	< 40	3000	Ø 3	M12	VK ...	OKTTI 55 M 30 FG3LK-IBS

### Application example

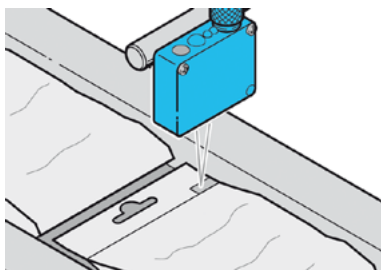

- Contrast sensor with high resolution for detecting print marks
- Auto-teach key / remote teach option / lock function
- Auto-teach during a running process
- LED indicator for the teach procedure

## Ultrasonic sensors

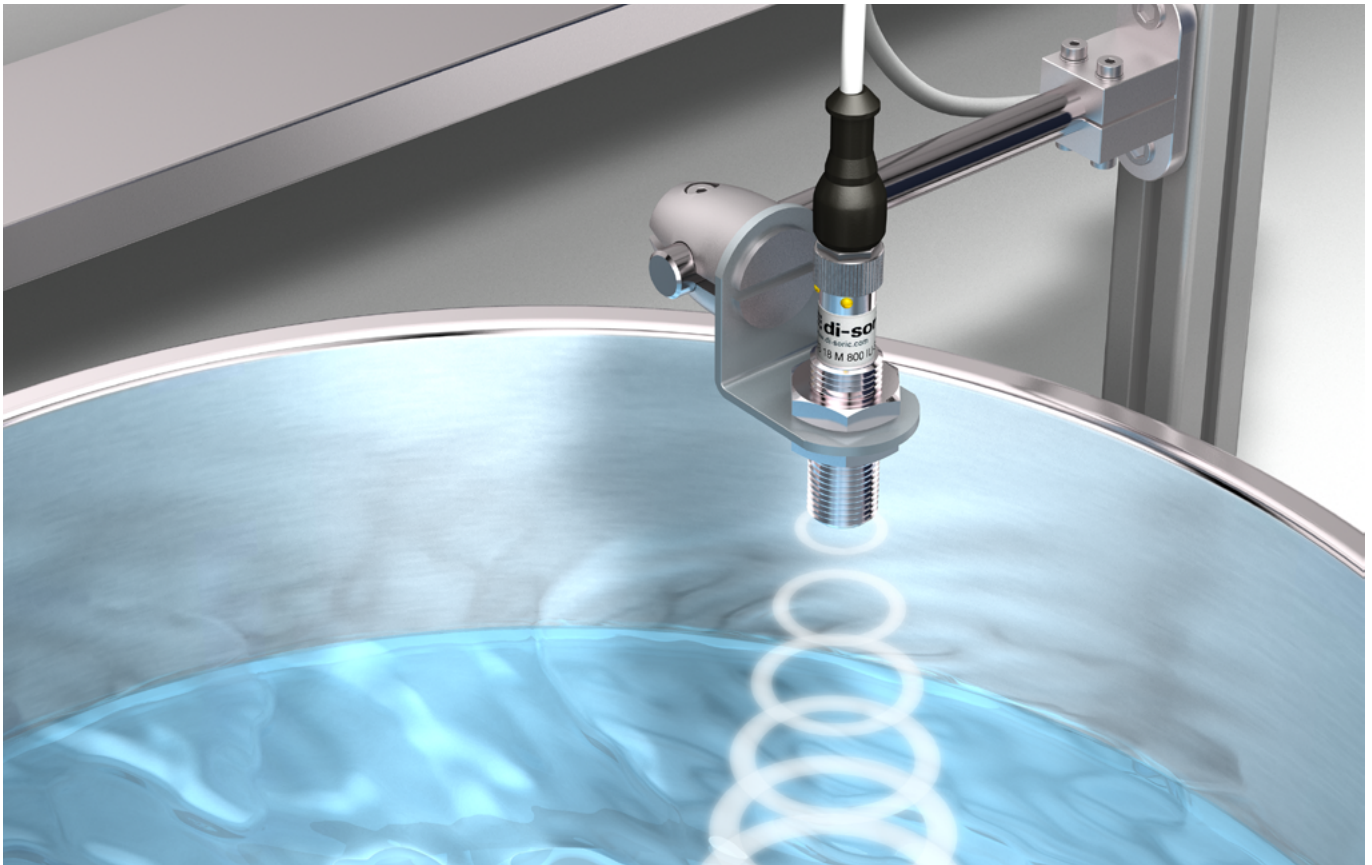

The ultrasonic sensors from di-soric are used as proximity switches in automation for distance measurement and for web edge control. They make it possible to detect objects with any color or surface. Even transparent, liquid and powdery objects are securely detected. The sensors are insensitive to contamination and can be operated across long distances.



 **di-soric**

US-M8	113
US-M12	113
US-Q12	114
US-M18	115
US-M30	116
USGT	117
US-Z Accessories for ultrasonic barriers/sensors	117

## US-M8

The US-M8 is the smallest ultrasonic sensor that can be integrated into machines very easily with its compact housing dimensions. At short ranges, the US-M8 offers maximum flexibility, even where installation space is limited, and is perfect for modernizing systems.

<b>Technical data (typ.)</b>	<b>+20 °C, 24 VDC</b>
Service voltage	18 to 30 V DC
For more information, visit	<a href="http://www.di-soric.com">www.di-soric.com</a>









	Operating range (mm)	Housing design Size (mm)	Sound outlet	Switching output	Analog output	Reproducibility	IO-Link	M/I/O	Ambient temperature (°C)	Plug connector	Connection cable (optionally available)	Product description
<b>US-M8</b>												
	20 to 100	M8 x 70	Axial	Push-pull, 150 mA NO/NC	–	0.3 mm	■		0 to 50	M8	TK ... /4	US 08 M 100 G3-B4

## US-M12

The US-M12 is the compact class of ultrasonic sensors in the M12 housing. Equipped with an IO-Link interface, the sensor can be operated to switch or to measure. The sensitivity can also be adjusted via auto-teach, so the sensor is thus operational within a few seconds.

<b>Technical data (typ.)</b>	<b>+20 °C, 24 VDC</b>
Service voltage	18 to 30 V DC
For more information, visit	<a href="http://www.di-soric.com">www.di-soric.com</a>





	Operating range (mm)	Housing design Size (mm)	Sound outlet	Switching output	Analog output	Reproducibility	IO-Link	M/I/O	Ambient temperature (°C)	Plug connector	Connection cable (optionally available)	Product description
<b>US-M12</b>												
	0 to 150	M12 x 65	Axial	Push-pull, 150 mA NO/NC	–	0.5 mm	■		-25 to 70	M12	VK ... /4	US 12 M 150 FB G3-B4
	20 to 200	M12 x 65	Axial	Push-pull, 150 mA NO/NC	–	0.5 mm	■		-25 to 70	M12	VK ... /4	US 12 M 200 G3-B4
	40 to 400	M12 x 65	Axial	Push-pull, 150 mA NO/NC	–	1.5 mm	■		-25 to 70	M12	VK ... /4	US 12 M 400 G3-B4
	0 to 150	M12 x 65	Axial	Push-pull, 150 mA NO/NC	0 to 10 V 4 to 20 mA	0.5 mm	■	■	-25 to 70	M12	VK ... /4	US 12 M 150 FB IU-B4
	20 to 200	M12 x 65	Axial	Push-pull, 150 mA NO/NC	0 to 10 V 4 to 20 mA	0.5 mm	■	■	-25 to 70	M12	VK ... /4	US 12 M 200 IU-B4
	40 to 400	M12 x 65	Axial	Push-pull, 150 mA NO/NC	0 to 10 V 4 to 20 mA	1.5 mm	■	■	-25 to 70	M12	VK ... /4	US 12 M 400 IU-B4

## US-Q12

The US-Q12 is the compact class in cubic form and with a small mounting depth. Equipped with an IO-Link interface, the sensor can be operated to switch or to measure. Its area of application is short distances, and the sensitivity is adjusted simply via auto-teach, potentiometer or IO-Link.

Technical data (typ.)	+20 °C, 24 VDC
Service voltage	18 to 30 V DC
For more information, visit	<a href="http://www.di-soric.com">www.di-soric.com</a>



	Operating range (mm)	Housing design Size (mm)	Sound outlet	Switching output	Analog output	Reproducibility	IO-Link	M/I/O	Ambient temperature (°C)	Plug connector	Connection cable (optionally available)	Product description
	20 to 200	M12x75	Radial	Push-pull, 150 mA NO/NC	–	0.5 mm	■		-25 to 70	M8	TK to /4	US Q12 M 200 G3-T4
	40 to 400	M12x82	Radial	Push-pull, 150 mA NO/NC	–	0.5 mm	■		-10 to 70	M8	TK to /4	US Q 12 M 400 FP G3-T4
	40 to 400	M12x75	Radial	Push-pull, 150 mA NO/NC	–	0.5 mm	■		-10 to 70	M8	TK to /4	US Q12 M 400 G3-T4
	40 to 400	M12x82	Radial	Push-pull, 150 mA NO/NC	–	0.5 mm	■		-10 to 70	M8	TK to /4	US Q12 M 400 FP G3-T4
	40 to 400	M12x75	Radial	Push-pull, 150 mA NO/NC	–	0.5 mm	■		-10 to 70	M8	TK to /4	US Q12 M 400 R G3-T4
	40 to 400	M12x82	Radial	Push-pull, 150 mA NO/NC	–	0.5 mm	■		-10 to 70	M8	TK to /4	US Q12 M 400 XP G3-T4
	20 to 200	M12x75	Radial	Push-pull, 150 mA	0 to 10 V 4 to 20 mA	0.5 mm	■	■	-25 to 70	M8	TK to /4	US Q12 M 200 IU-T4
	40 to 400	M12x75	Radial	Push-pull, 150 mA	0 to 10 V 4 to 20 mA	0.5 mm	■	■	-10 to 70	M8	TK to /4	US Q12 M 400 IU-T4

## US-M18

The US-M18 is the standard variant in a short design, which makes this sensor very compact. It is suited for medium ranges and can be operated to switch or to measure. Thanks to three modes and other settings, the auto-teach is exceptionally easy. IO-Link ensures constant monitoring of the device functions and parameters and offers extended adjustment options.

Technical data (typ.)	+20 °C, 24 VDC
Service voltage	18 to 30 V DC
For more information, visit	<a href="http://www.di-soric.com">www.di-soric.com</a>



	Operating range (mm)	Housing design Size (mm)	Sound outlet	Switching output	Analog output	Reproducibility	Accuracy	IO-Link	M/I/O	Ambient temperature (°C)	Plug connector	Connection cable (optionally available)	Product description
<b>US-M18</b>													
	80 to 800	M18 x 55.5	Axial	Push-pull, 150 mA NO/NC, switchable	–	1 mm		■		-25 to 70	M12	VK ... /4	US 18 M 800 G3-B4
	150 to 1,500	M18 x 55.5	Axial	Push-pull, 150 mA NO/NC, switchable	–	1 mm		■		-25 to 70	M12	VK ... /4	US 18 M 1500 G3-B4
	80 to 800	M18 x 55.5	Axial	Push-pull, 150 mA	0 to 10 V 4 to 20 mA	1 mm		■	■	-25 to 70	M12	VK ... /4	US 18 M 800 IU-B4
	150 to 1,500	M18 x 55.5	Axial	Push-pull, 150 mA	0 to 10 V 4 to 20 mA	1 mm		■	■	-25 to 70	M12	VK ... /4	US 18 M 1500 IU-B4

## US-M30

The US-M30 is the right choice for large ranges up to 6,000 mm. It is distinguished by its compact, short design. The sensor can be operated to measure and switch. The US M30 is quickly operational thanks to simple teach-in and IO-Link.



Technical data (typ.)	+20 °C, 24 VDC
Service voltage	18 to 30 V DC
For more information, visit	<a href="http://www.di-soric.com">www.di-soric.com</a>

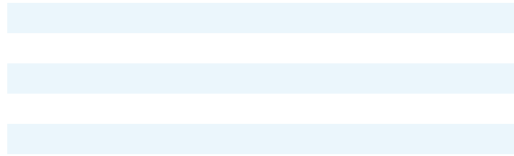

	Operating range (mm)	Housing design Size (mm)	Sound outlet	Switching output	Analog output	Reproducibility	IO-Link	M/I/O	Ambient temperature (°C)	Plug connector	Connection cable (optionally available)	Product description
<b>US-M30</b>												
	300 to 3,000	M30 x 60	Axial	Push-pull, 100 mA NO/NC	–	2.0 mm	■		-25 to 70	M12	VK... /4	US 30 M 3000 G3-B4
	600 to 6,000	M30 x 78	Axial	Push-pull, 100 mA NO/NC	–	4.0 mm	■		-25 to 70	M12	VK... /4	US 30 M 6000 G3-B4
	300 to 3,000	M30 x 60	Axial	Push-pull, 100 mA NO/NC	0 to 10 V 4 to 20 mA	2.0 mm	■	■	-25 to 70	M12	VK... /4	US 30 M 3000 IU-B4
	600 to 6,000	M30 x 78	Axial	Push-pull, 100 mA NO/NC	0 to 10 V 4 to 20 mA	4.0 mm	■	■	-25 to 70	M12	VK... /4	US 30 M 6000 IU-B4

## USGT

The USGT ultrasonic fork sensors are balanced sensors for determining the position of edges in films and paper (transparent, non-transparent and reflective). The sensors are distinguished by a very high repetition accuracy. They are insensitive to dirt and have a robust metallic housing in a high protection type.

Technical data (typ.)	+20 °C, 24 VDC
Service voltage	12 to 30 V DC
For more information, visit	<a href="http://www.di-soric.com">www.di-soric.com</a>



	Operating range (mm) fork width / measuring range (mm)	Housing design Size (mm)	Measuring frequency	Analog output	Reproducibility	Ambient temperature (°C)	Protection type	Plug connector	Connection cable (optionally available)	Product description
<b>USGT</b>										
	30/8	74 x 30 x 65	500 Hz	0 to 10 V, 4 to 20 mA	± 0.1 mm	0 ... 60	IP 67	M12	VKHM ... /4	USGT 30/8 IU-B4
	40/13	92 x 39 x 80	285 Hz							USGT 40/13 IU-B4
	60/8	104 x 30 x 65	500 Hz							USGT 60/8 IU-B4
	70/13	122 x 39 x 80	285 Hz							USGT 70/13 IU-B4

## US-Z ACCESSORIES FOR ULTRASONIC BARRIERS/SENSORS

By simply screwing on the deflection angle on sensors in the sizes M12 and M18, the exit of sound is deflected by 90°. This is advantageous for assembly primarily in narrow spaces.

Deflection angle for ultrasound sensors		
	For ultrasound sensors with thread M12	US-UW-12
	For ultrasound sensors with thread M18	US-UW-18

## Capacitive proximity sensors

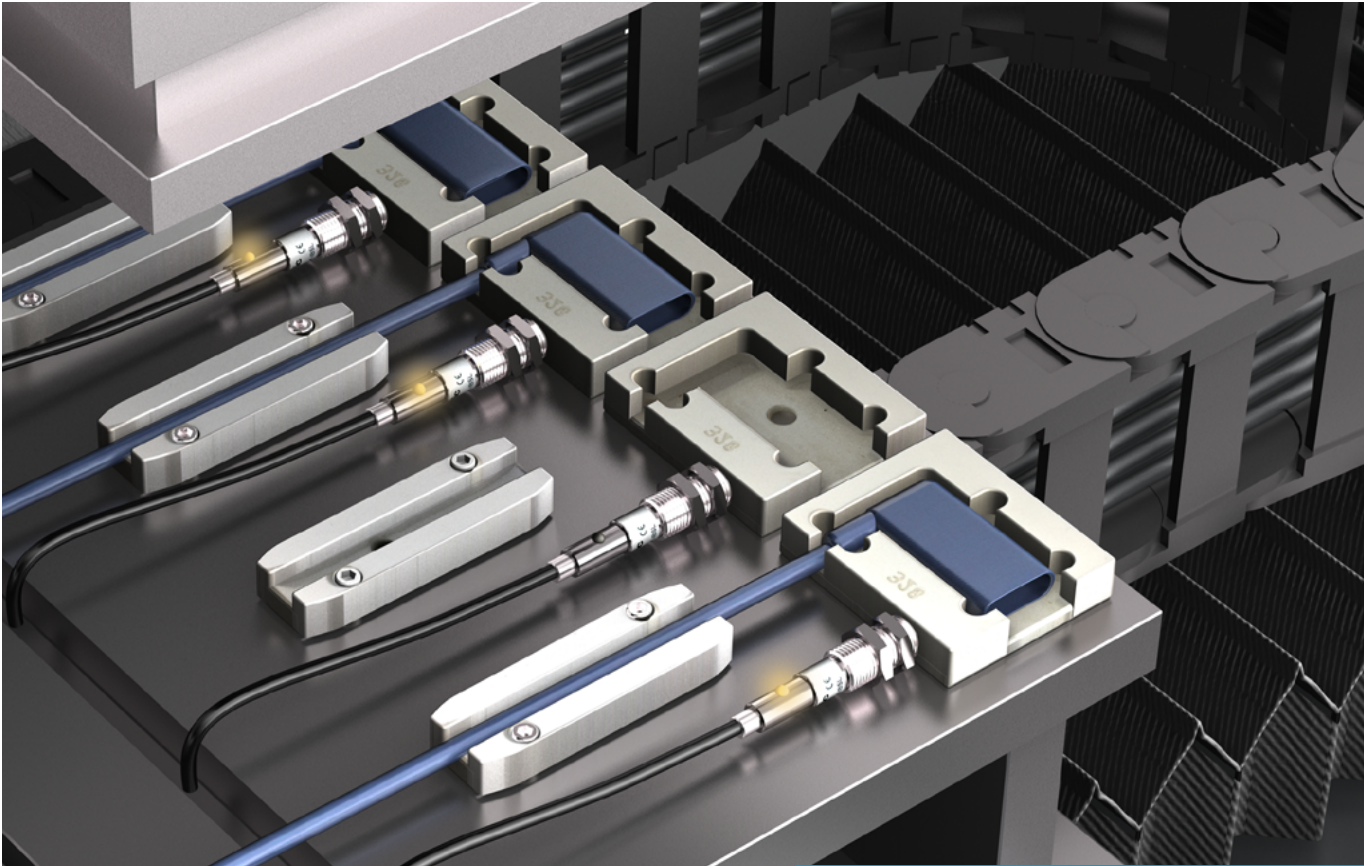

Our capacitive proximity sensors detect liquid, powdery and solid materials precisely and reliably. They are equally suitable for the detection of metallic and non-metallic parts. Parts can also be detected through container walls or packaging.

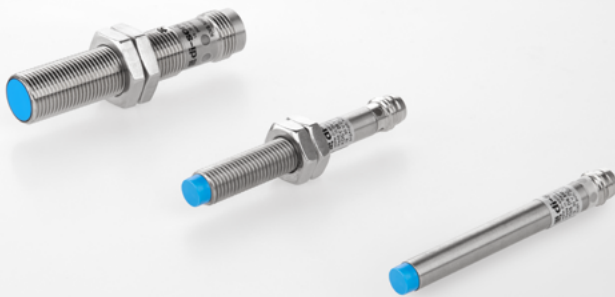

 **di-soric**

KNS Extended	119
KDC Standard	121
Installation instructions	122



## KNS EXTENDED

Our capacitive proximity sensors detect liquid, powdery and solid materials precisely and reliably, even through container walls or packaging. They are equally suitable for the detection of metallic and non-metallic parts. The sensitivity and NO/NC switching is adjusted using the Smart Sensor Profile. The sensors are available in the smallest sizes Ø 6.5mm, M8 and M12.



Technical data (typ.)	+20 °C, 24 VDC
Sensitivity adjustment	via IO-Link or multturn potentiometer
Operation modes	<b>Standard</b> (general applications)
	<b>High Resolution</b> (for detecting very small objects)
	<b>Speed</b> (reliable detection of fast-moving parts)
Installation instructions	flush / non-flush / virtually flush (see page 122)
For more information, visit	<a href="http://www.di-soric.com">www.di-soric.com</a>

### Operation modes



**Standard** – General applications

- Switching frequency 100 Hz
- Normal interference immunity



**High Resolution** – For detecting very small objects

- Stable measured value
- Reduced switching frequency 10 Hz
- High interference immunity







**Speed** – Reliable detection of fast-moving parts

- Fast object detection
- Switching frequency 300 Hz
- Low interference immunity

	Housing design Size (mm)	Switching distance (mm)	flush (f) / non-flush (nf)	Switching output	Switching frequency (Hz) / mode	IO-Link adjustments	Potentiometer sensitivity adjustments	Housing material	Protection type	Cable material/length, Plug connector	Product description
	Ø 6.5x37.6	2.0 <sup>1)</sup> (0.2 to 3.0)	f	Push-pull, 100 mA, NO/NC	100 (Standard) 10 (High resolution) 200 (Speed)	■		Stainless steel V2A	IP 65, IP 67	2 m/PVC	KNS D6.5KM 2B G3-2R
	Ø 6.5x45									M8	KNS D6.5KM 2B G3-T3
	Ø 6.5x40.6	3.0 <sup>1)</sup> (0.2 to 4.0)	nf	Push-pull, 100 mA, NO/NC	100 (Standard) 10 (High resolution) 200 (Speed)	■		Stainless steel V2A	IP 65, IP 67	2 m/PVC	KNS D6.5 KM 3N G3-2R
	Ø 6.5x48									M8	KNS D6.5 KM3N G3-T3
	M8 x 40.6	3.0 <sup>1)</sup> (0.2 to 4.0)	nf	Push-pull, 100 mA, NO/NC	100 (Standard) 10 (High resolution) 200 (Speed)	■		Stainless steel V2A	IP 65, IP 67	2 m/PVC	KNS M08KM 3N G3-2R
	M8 x 48									M8	KNS M08 KM 3N G3-T3
	M12 x 40	4.0 <sup>1)</sup> (0.3 to 8.0)	f	Push-pull, 100 mA, NO/NC	100 (Standard) 10 (High resolution) 200 (Speed)	■		Brass, nickel-plated	IP 65, IP 67	2 m/PVC	KNS M12KM 4B G3-2R
	M12 x 45									M12	KNS M12KM 4B G3-B3
	M12 x 44	8.0 <sup>1)</sup> (0.3 to 12)	nf	Push-pull, 100 mA, NO/NC	100 (Standard) 10 (High resolution) 200 (Speed)	■		Brass, nickel-plated	IP 65, IP 67	2 m/PVC	KNS M12KM 8N G3-2R
	M12 x 49									M12	KNS M12KM 8N G3-B3
	M8 x 37.5	2.0 <sup>1)</sup> (0.2 to 3.0)	f	Push-pull, 100 mA, NO/NC	100 (Standard) 10 (High resolution) 200 (Speed)	■		Stainless steel V2A	IP 65, IP 67	2 m/PVC	KNS M08KM 2B G3-2R
	M8 x 45									M8	KNS M08KM 2B G3-T3

<sup>1)</sup>Switching distance adjustment via IO-Link

	Housing design Size (mm)	Switching distance (mm)	flush (f) / non-flush (nf)	Switching output	Switching frequency (Hz) / mode	IO-Link adjustments	Potentiometer sensitivity adjustments	Housing material	Protection type	Cable material/length, Plug connector	Product description
	Ø 6.5x52	2.0 (0.1 to 3.0)	f	Push-pull, 100 mA, NO/NC	100 Hz	■		Stainless steel V2A	IP 65, IP 67	2 m/PVC	KNS D6.5M 02B G3-2R
	Ø 6.5x60									M8	KNS D6.5M 02B G3-T3
	Ø 6.5x52	3.0 (0.1 to 4.0)	nf	Push-pull, 100 mA, NO/NC	100 Hz	■		Stainless steel V2A	IP 65, IP 67	2 m/PVC	KNS D6.5M 03N G3-2R
	Ø 6.5x60									M8	KNS D6.5M 03N G3-T3
	M8 x 52	3.0 (0.1 to 4.0)	nf	Push-pull, 100 mA, NO/NC	100 Hz	■		Stainless steel V2A	IP 65, IP 67	2 m/PVC	KNS M8M 03N G3-2R
	M8 x 60									M8	KNS M8M 03N G3-T3
	M12 x 55	4.0 (0.1 to 8.0)	f	Push-pull, 100 mA, NO/NC	100 Hz	■		Stainless steel V2A	IP 65, IP 67	2 m/PVC	KNS M12M 04B G3-2R
	M12 x 60									M12	KNS M12M 04B G3-B3
	M8 x 52	2.0 (0.1 to 3.0)	f	Push-pull, 100 mA, NO/NC	100 Hz	■		Stainless steel V2A	IP 65, IP 67	2 m/PVC	KNS M8M 02B G3-2R
	M8 x 60									M8	KNS M8M 02B G3-T3

## KDC STANDARD

Capacitive proximity sensors in the KDC series are available in stainless steel and plastic housings. They are particularly suited for the detection of liquid, powdery and solid materials, as well as metallic and non-metallic parts. They are available in different sizes from M18 to M30 and  $\varnothing$  50 mm.



Technical data (typ.)	+20 °C, 24 VDC
Sensitivity adjustment	Using multiturn potentiometer or auto-teach key
Installation instructions	flush / non-flush / virtually flush (see page 122)
For more information, visit	<a href="http://www.di-soric.com">www.di-soric.com</a>

	Housing design Size (mm)	Switching distance (mm)	flush (f) / non-flush (nf)	Switching output	Potentiometer sensitivity adjustments Auto-teach key	Housing material	Protection type	Cable material/length, Plug connector	Product description
	$\varnothing$ 6.5x55	2.0 (0.1 to 3.0)	f	Push-pull, 150 mA, NO/NC	■	Stainless steel V2A	IP 65, IP 67	2 m/PUR	KDCT 6.5 V 02 G3-3
								2 m/PUR	KDCT 6.5 V 02 G3-4
	$\varnothing$ 6.5x60	2.0 (0.1 to 3.0)	f	Push-pull, 150 mA, NO/NC	■	Stainless steel V2A	IP 65, IP 67	M8 3-pin	KDCT 6.5 V 02 G3-T3
								M8 4-pin	KDCT 6.5 V 02 G3-T4
	M8 x 52	2.0 (0.1 to 3.0)	f	Push-pull, 150 mA, NO/NC	■	Stainless steel V2A	IP 65	2 m/PUR	KDCT 08 V 02 G3-3
									KDCT 08 V 02 G3-4
	M8 x 60	2.0 (0.1 to 3.0)	f	Push-pull, 150 mA, NO/NC	■	Stainless steel V2A	IP 65	M8	KDCT 08 V 02 G3-T3
									KDCT 08 V 02 G3-T4
	M8 x 60	3.0 (0.1 to 4.0)	nf	Push-pull, 150 mA, NO/NC	■	Stainless steel V2A	IP 65	M8	KDCT 08 V 03 G3-T3
									KDCT 08 V 03 G3-T4
	M12x60	4.0 (0.1 to 6.0)	f	Push-pull, 150 mA, NO/NC, switchable	■	Stainless steel V2A	IP 65	2 m/PUR	KDCT 12 V 04 G3-4
								M12	KDCT 12 V 04 G3-B4

<sup>1</sup>Front side <sup>2</sup>Back side

## INSTALLATION INSTRUCTIONS FOR CAPACITIVE PROXIMITY SENSORS

### Flush installation (f)

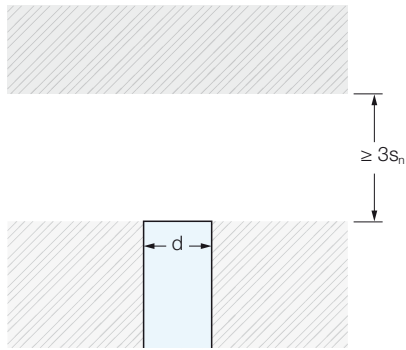

These proximity switches can be installed in all materials (metals / non-metals) such that the active sensor surface lines up flush with the surrounding material on the front side.

They have the following advantages:

- Flush installation in conductive materials (metals)
- Protection of the sensing surface prior to mechanical damage
- Less influence from external interference fields
- Less distance to the next proximity switch on the side

### Non-flush installation (nf)

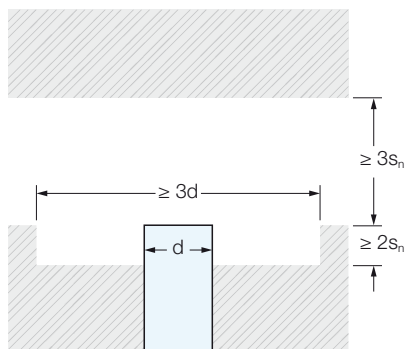

These proximity switches are allowed to be installed non-flush in conductive materials.

They have the greatest possible switching distance. Special installation instructions apply to these proximity switches.

Flush installation in nonconductive materials is permitted.



## Label sensors

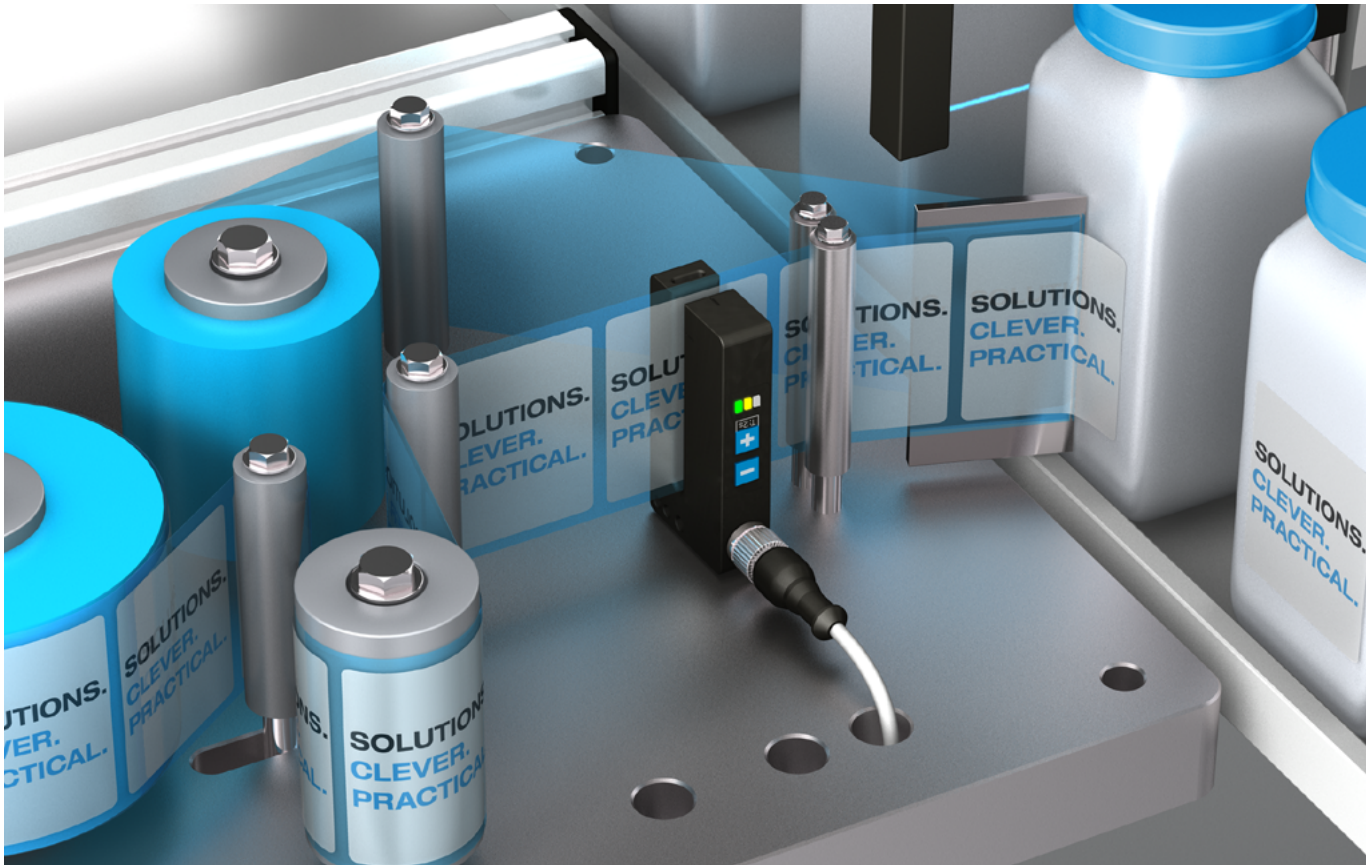

When our sensors are used for label detection in a fork construction, labels can be positioned precisely at high belt speeds. They have been calibrated to a variety of different label materials (paper, metallic, transparent, thin/thick) and are available with different functional principles (optical/capacitive/ultrasonic).



 **di-soric**

OGUTI Optical	125
UGUTI Ultrasonic	126
KSSTI Capacitive	127

Detection	Optical	Capacitive	Ultrasonic
Series	OGUTI	KSSTI	UGUTI
Very small labels	✓	✓	✓
Transparent labels		✓	✓
Metallic labels	✓		✓
Very thin labels	✓	✓	✓
Thick labels	✓	✓	✓
Booklets	✓		✓
Thick carrier material		✓	✓

Special requirements			
Exact positioning	✓	✓	✓
Maximum belt speed	✓		
Maximum reproducibility	✓		
Mounting directly on the dispensing edge	✓		
IO-Link			✓
Manual teach			✓
Auto-teach	✓	✓	✓
Remote teach	✓	✓	✓
Adjustable pulse stretching (using IO-Link)			✓
Warning output			✓

## OGUTI OPTICAL

The compact, OGUTI optical label sensors detect both thin and thick paper labels with outstanding speed and precision thanks to their large fork openings. They stand out for their extremely high dispensing precision and reproducibility, making maximum belt speeds possible. Using auto-teach, they can be taught in to new materials quickly and intuitively.

Technical data (typ.)	+20 °C, 24 VDC
Service voltage	10 to 35 V DC
Ambient temperature	-10 to +60 °C
Housing material	Die-cast zinc, varnished



	Fork/slot width (mm)	Slot depth (mm)	Infrared light, 880 nm, clocked	Switching output	IO-Link interface	No-load current (mA)	Activation time (µs)	Max. belt speed (m/min)	Reproducibility (µm)	Sensitivity adjustment using teach button	Sensitivity adjustment using remote teaching	Plug connector	Connection cable (optionally available)	Product description
	2	40	■	pnp 200 mA, NO/NC		35	166	500	< 50	■	■	M8	TK ...	OGUTI 002 P3K-TSSL
													TK ... /4	OGUTI 002 FP3K-TSSL
	5	50	■	Push-pull 200 mA, NO/NC		35	166	500	< 50	■	■	M8	TK ...	OGUTI 005/50 G3K-TSSL
													TK ... /4	OGUTI 005/50 FG3K-TSSL

## UGUTI ULTRASONIC

The UGUTI ultrasonic label sensors can be used universally for a wide variety of label materials. They reliably detect not only thin and thick transparent, foil and paper labels but also metallic labels. The innovative dual operation concept—implemented using either IO-Link or auto-teach—makes it possible to put the sensors into operation quickly.

Technical data (typ.)	+20 °C, 24 VDC
Service voltage	10 to 30 V DC
Ambient temperature	0 to +60 °C
Housing material	Aluminum, black anodized



UGUTI Ultrasonic														
	Fork/slot width (mm)	Slot depth (mm)	Infrared light, 880 nm, clocked	Switching output	IO-Link interface	No-load current (mA)	Activation time (µs)	Max. belt speed (m/min)	Reproducibility (µm)	Sensitivity adjustment using teach button	Sensitivity adjustment using remote teaching	Plug connector	Connection cable (optionally available)	Product description
	6	70		2 independent outputs, push-pull, 100 mA, NO/NC	■	40	<250	250 <sup>1)</sup>	<200 <sup>2)</sup>	■	■	M12 M12 (radial)	VK .../5	UGUTI 6/70 G6-B5 UGUTI 6/70 G6-RB5

<sup>1)</sup> 2 mm label and 2 mm gap  
<sup>2)</sup> Depends on the label material and carrier material



## KSSTI CAPACITIVE

The KSSTI capacitive label sensors are the solution of choice for detecting thin transparent labels, foil labels and paper labels. They show their strengths particularly well wherever high tape speeds are required. Using auto-teach, they are taught in to new materials quickly and intuitively.

Technical data (typ.)	+20 °C, 24 VDC
Service voltage	10 to 35 V DC
Ambient temperature	0 to +60 °C
Housing material	Aluminum, black anodized



	Fork/slot width (mm)	Slot depth (mm)	Infrared light, 880 nm, clocked	Switching output	IO-Link interface	No-load current (mA)	Activation time (µs)	Max. belt speed (m/min)	Reproducibility (µm)	Sensitivity adjustment using teach button	Sensitivity adjustment using remote teaching	Plug connector	Connection cable (optionally available)	Product description
	0.4	50		Push-pull 200 mA, NO/NC		70	< 600	300 <sup>1)</sup>	< 150 <sup>2)</sup>	■	■	M8	TK ...	KSSTI 400 G3K-TSSL
										■	■		TK ... /4	KSSTI 400 FG3K-TSSL
	0.6	50		Push-pull 200 mA, NO/NC		70	< 600	300 <sup>1)</sup>	< 150 <sup>2)</sup>	■	■	M8	TK ...	KSSTI 600 G3K-TSSL
										■	■		TK ... /4	KSSTI 600 FG3K-TSSL
	1.0	50		Push-pull 200 mA, NO/NC		70	< 600	300 <sup>1)</sup>	< 150 <sup>2)</sup>	■	■	M8	TK ...	KSSTI 1000 G3K-TSSL
										■	■		TK ... /4	KSSTI 1000 FG3K-TSSL
	0.6	85		Push-pull 200 mA, NO/NC		70	< 600	300 <sup>1)</sup>	< 150 <sup>2)</sup>	■	■	M12	VK ... /4	KSSTI 600/80 FG3LK-IBS
	1.0	85		Push-pull 200 mA, NO/NC		70	< 600	300 <sup>1)</sup>	< 150 <sup>2)</sup>	■	■	M12	VK ... /4	KSSTI 1000/80 FG3LK-IBS
	0.6	85		Push-pull 200 mA, NO/NC		70	< 600	300 <sup>1)</sup>	< 150 <sup>2)</sup>	■	■	M12	VK ... /4	KSSTI 600/80 FG3LK-AIBS
	1.0	85		Push-pull 200 mA, NO/NC		70	< 600	300 <sup>1)</sup>	< 150 <sup>2)</sup>	■	■	M12 (radial)	VK ... /4	KSSTI 1000/80 FG3LK-AIBS

<sup>1)</sup> 2 mm label and 2 mm gap

<sup>2)</sup> Depends on the label material and carrier material

## Magnetic field sensors

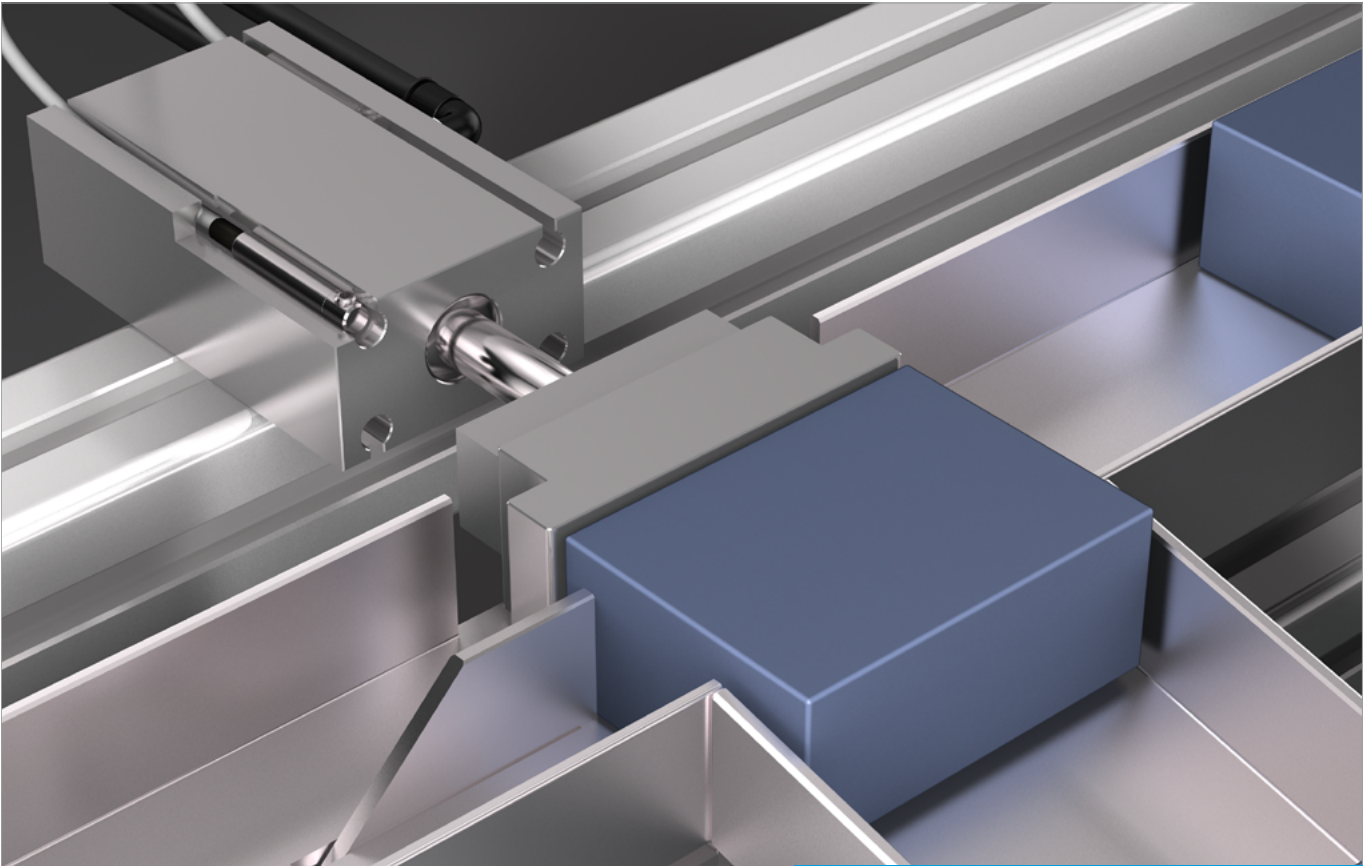

Magnetic field sensors are designed for pneumatic cylinders with integrated magnets. The piston position is detected through the cylinder wall.



 **di-soric**

MZEC Cylinder sensors C-groove 129

MZET Cylinder sensors T-groove 130

MZES gripper sensors 131

## MZEC CYLINDER SENSORS C-GROOVE







Our cylinder sensors for the C groove are designed for all common pneumatic cylinders with installed magnets.

Technical data (typ.)	+20 °C, 24 VDC
Service voltage	10 to 30 V DC
Switching output	Transistor pnp / NO
Voltage drop	2.0 V
	2.5 V (MZEx 9-xx...)
Switching frequency	1,000 Hz
Ambient temperature	-25 to +70 °C
	-25 to +80 °C (MZEC 9-xx...)
Insulation voltage endurance	500 V
Polarity-safe	Yes
Protection type	IP 67



← Mounting lengthwise along the groove



↓ Can be inserted into the groove from above

Housing design Size (mm)	Installation method	Housing material	Switching output	Short-circuit-proof	Reproducibility (mm)	Cable length (m)	Plug connector	Connection cable (optionally available)	PUF connection cable, welding spark-resistant	Product description
	Ø 3.7x21	←	V2A (1.4301 / AISI 304) / plastic	Transistor pnp 100mA, NO		0.1	2.5	–	–	MZEC 3.7 PSL
							0.3	M8	TK ...	MZEC 3.7 PS-K-TSSL
							0.6	M8	TK ...	MZEC 3.7 PS-K0.6-TSSL
							0.3	M12	VK ...	MZEC 3.7 PS-K-IBS
	Ø 3.7x21	←	V2A (1.4301 / AISI 304) / plastic	Transistor pnp 100mA, NO		0.1	0.3	M8	TK ...	MZEC 3.7 VPS-K-T3
							0.6	M8	TK ...	MZEC 3.7 VPS-K0.6-T3
							0.3	M12	VK ...	MZEC 3.7 VPS-K-B3
	Ø 3.7x21	←	V2A (1.4301 / AISI 304) / plastic	Transistor pnp 100mA, NO		0.1	0.3	M8	TK ...	MZEC 3.7 VNS-K-T3
							0.6	M8	TK ...	MZEC 3.7 VNS-K0.6-T3
							0.3	M12	VK ...	MZEC 3.7 VNS-K-B3
	Ø 4.0x25	←	V2A (1.4301 / AISI 304) / plastic	Transistor pnp 100mA, NO		0.1	2.5	–	–	MZEC 4.0 PSL
							0.3	M8	TK ...	MZEC 4.0 PS-K-TSSL
							0.6	M8	TK ...	MZEC 4.0 PS-K0.6-TSSL
							0.3	M12	VK ...	MZEC 4.0 PS-K-IBS
	2.8 x 7.7 x 17.5	↓	Polyamide, mounting eccentric stainless steel	Transistor pnp 100mA, NO	■	0.2	2.0	–	–	MZEC 9-18 PSL
							0.3	M8	TK ...	MZEC 9-18 PSL-K-TSS
	2.8 x 5 x 25.8	↓	Polyamide, mounting eccentric stainless steel	Transistor pnp 100mA, NO	■	0.2	2.0	–	–	MZEC 9-26 PSL
							0.3	M8	TK ...	MZEC 9-26 PSL-K-TSS









## MZET CYLINDER SENSORS T-GROOVE

Our cylinder sensors MZET for the T groove are designed for all common pneumatic cylinders with installed magnets.

Technical data (typ.)	+20 °C, 24 VDC
Service voltage	10 to 30 V DC
Switching output	Transistor pnp / NO
Voltage drop	2.0 V
Switching frequency	1,000 Hz
Ambient temperature	-25 to +70 °C
Insulation voltage endurance	500 V
Polarity-safe	Yes
Protection type	IP 67

 Mounting lengthwise along the groove  
 Can be inserted into the groove from above



	Housing design Size (mm)	Installation method	Housing material	Switching output	Short-circuit-proof	Reproducibility (mm)	Cable length (m)	Plug connector	Connection cable (optionally available)	Connection cable, PUR, welding-spark-resistant	Product description
	5 x 7 x 17		Die-cast zinc	Transistor pnp, 200 mA, NO	■	0.1	–	M8	TK ...		MZERT 17 PSK-TSSL
	5 x 7 x 20		Die-cast zinc	Transistor pnp, 200 mA, NO	■	0.1	–	M8	TK ...		MZERTI 20 PSK-TSSL <sup>1)</sup> MZERTI 20 PSK-TSSL <sup>1)</sup>
	6.1 x 5 x 25		Die-cast zinc	Transistor pnp, 200 mA, NO	■	0.1	2.5 0.3 0.6 0.3	– M8 M8 M12	– TK ... TK ... VK ...	■	MZET 25 PSLK MZET 25 PSK-K-TSSL MZET 25 PSK-K0.6-TSSL MZET 25 PSK-K-IBS
	6.1 x 5 x 28		Die-cast zinc	Transistor pnp, 200 mA, NO	■	0.1	2.5 0.3 0.6 0.3	– M8 M8 M12	– TK ... TK ... VK ...	■	MZET 28 PSLK MZET 28 PSK-K-TSSL MZET 28 PSK-K0.6-TSSL MZET 28 PSK-K-IBS
	5 x 6.5 x 25		Polyamide, mounting eccentric stainless steel	Transistor pnp, 200 mA, NO	■	0.2	2.0 0.3 0.3	– M8 M12	– TK ... VK ...	■	MZET 9-25 PSL MZET 9-25 PSL-K-TSS MZET 9-25 PSL-K-IBS
	5.2 x 6.5 x 25		Die-cast zinc	Transistor pnp, 200 mA, NO	■	0.1	2.5 0.3 0.6 0.3	– M8 M8 M12	– TK ... TK ... VK ...	■	MZEK 25 PSLK <sup>2)</sup> MZEK 25 PSK-K-TSSL <sup>2)</sup> MZEK 25 PSK-K0.6-TSSL <sup>2)</sup> MZEK 25 PSK-K-IBS <sup>2)</sup>

<sup>1)</sup> With an Allen screw

<sup>2)</sup> Mounting with clamping wedge (internal hex SW 1.5 mm)

## MZES GRIPPER SENSORS

Our gripper sensors are designed and developed for gripper systems that are used in automated processes as end-of-arm tooling on portals and robots. The gripper systems are designed individually for the respective application cases in the most varied industries.



Technical data (typ.)	+20 °C, 24 VDC
Service voltage	10 to 30 V DC
Switching output	Transistor pnp / NO
Voltage drop	2.0 V
Switching frequency	1,000 Hz
Ambient temperature	-25 to +70 °C
Insulation voltage endurance	500 V
Polarity-safe	Yes
Protection type	IP 67

Mounting lengthwise along the groove  
 Can be inserted into the groove from above

	Housing design Size (mm)	Installation method	Housing material	Switching output	Reproducibility (mm)	Cable length (m)	Plug connector	Connection cable (optionally available)	Product description
<b>MZES gripper sensors for the C-groove</b>									
	Ø3.9x21		Stainless steel, plastic	Transistor pnp, 100 mA, NO	0.1	2.5	–	–	MZES 3.9 PSL
						0.3	M8	TK ...	MZES 3.9 PS-K-TSSL
						0.6	M8	TK ...	MZES 3.9 PS-K0.6-TSSL
<b>MZES gripper sensors for the T-groove</b>									
	6.1 x 5 x 25		Die-cast zinc	Transistor pnp, 100 mA, NO	0.1	2.5	–	–	MZES 25 PSL
						0.3	M8	TK ...	MZES 25 PS-K-TSSL
						2.5	–	–	MZES 25 PSL *
						0.3	M8	TK ...	MZEKS 25 PS-K-TSSL *

\* Mounting with clamping wedge

# Special sensors



Our special sensors solve special detection tasks and are designed for specific applications. di-soric's range of products thus includes movement sensors for contact-free detection of movements.





OBS Optical motion sensors	133
RS Radar sensors	134

## OBS OPTICAL MOTION SENSORS

The OBS optical movement sensors are used for contact-free close-range detection of movements and direction of movement. The sensors have a detection range of 20 mm to 40 mm. They can distinguish between movement and standstill and, have an option for detecting the direction of movement. The standstill speed up to 5 m/s is easy to set using a potentiometer.

Technical data (typ.)	+20 °C, 24 VDC
Service voltage	10 to 30V DC
No-load current	30mA
Diameter of light spot	Ø 2.0mm
Working distance	30±10 based on material
Pulse stretching	1 to 1,000 ms, adjustable
Activation time	10 ms
Emitted light	Infrared laser, 850nm
Laser class (EN 60825-1)	1M
Ambient light immunity	5 kLx
Ambient temperature	+5 to +45 °C
Insulation voltage endurance	500V
Protection type	IP 67
Protection class	III, operation on protective low voltage
Housing material	Aluminum, black anodized
Window material	PMMA

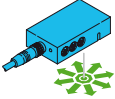

	Movement sensor	Detection of direction	Emitted light	Speed (m/s, based on material)	Push-pull, 150mA	NO/NC, switchable	NO	Voltage drop (V)	LED: Switching output	LED: Switching output (yellow), operation (green)	Plug connector	Connection cable (optionally available)	Product description
	■		 Laser, infrared	< 5.0	1x	■		2.5	■		M8, 3-pin	TK ...	OBS 60 M 30 G3-T3
	■	X or Y	 Laser, infrared	< 5.0	2x		■	2.0	2x		M8, 4-pin	TK ... /4	OBSR 60 M 30 G8-T4

## RS RADAR SENSORS

Radar movement sensors are used for contact-free detection of large objects and distinguish between approaching and departing objects at a distance of 0.5 m to 6 m. The sensitivity or size of the part to detect can be adjusted and small parts can thereby be hidden. Due to their robust nature and the high protection type, these radar sensors are also very well suited for the outdoors.

Technical data (typ.)	+20 °C, 24 VDC
Service voltage	10 to 35 V DC
No-load current	35 mA
Working distance	500 to 6,000 mm
Pulse stretching	0.1 to 30 s adjustable
Activation time	10 ms
Switching frequency	< 2 Hz
Working frequency	24.125 GHz, K-band
Ambient temperature	-20 to +60 °C
Insulation voltage endurance	500 V
Protection type	IP 67
Protection class	III, operation on protective low voltage
Housing material	Die-cast zinc, black painted



RS Radar sensors										
	Radar sensor	Switching output for detection of approximation and distance	Direction-dependent switching output for detection of approximation and distance	Push-pull, 200 mA	NO/NC, switchable	Voltage drop (V)	LED: Operation (green), Distance (yellow), Proximity (yellow)	Plug connector	Connection cable (optionally available)	Product description
	■	1x	■	■	2.0	■	M12	VK...	RS 40 M 6000 G3L-IBS	
	■	2x	■	■	2.0	■	M12	VK...	RS 40 M 6000 G8L-IBS	





## Vision sensors

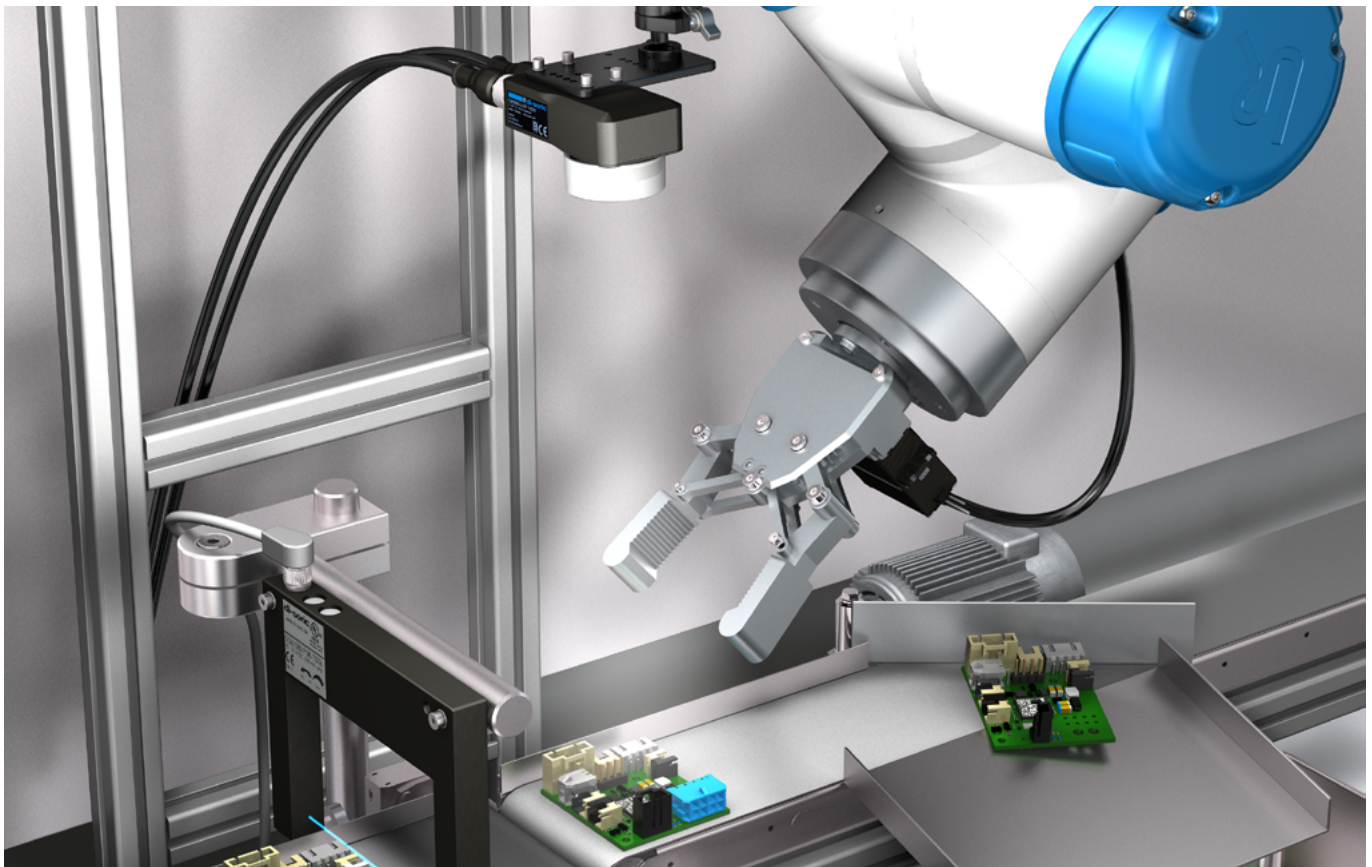

The Vision Sensors from di-soric are intuitively operated Smart Vision sensor systems that can be put into operation within minutes and without training. The Vision Sensors can be used out-of-box and have an extensive assortment of software tools and standardized interfaces for communication with peripherals.



 **di-soric**

CS-60

137

CS-60 Upgrade licenses

138

## CS-60

Due to easy lens changing and integrated high-performance illumination, the CS-60 creates excellent images with respect to distance, field of vision and resolution. The extensive tools can be easily expanded through software upgrades and may be individually customized as needed. Comfortable, logical linking of tools and the versatile Profinet connection to the existing PLS component complete its flexibility.

Technical data (typ.)	+20 °C, 24 VDC
Service voltage	18 to 30 VDC
No-load current	< 1000 mA, (24 V DC)
Voltage drop	< 2.0 V
Insulation voltage endurance	500 V
Housing material	Die-cast zinc (black powder-coated)
Ambient temperature	0 to +50 °C
Lens connection	S-mount
Weight	250 g
Protection class	III, operation on protective low voltage
Working distance	50 to 2000 mm
Model	CS 60
Design	Cuboid design
Internal lighting	High Power red, High Power white
Switching output	Push-pull, 150 mA
Interfaces & protocols	Digital I/O, TCP/IP, Profinet, HTTP, FTP/SFTP, ReST API
Focal length	8 mm
Resolution	736 x 480 pixels
Display	LED green - in operation, yellow - DATA-Link yellow - Trigger
Ambient temperature during operation	0 to +50 °C
Protection type	IP 67
Connection	Connector, M12, 12-pin (A-coded)
Connection 2	Socket, M12, 8-pin



CS-60	Software					Resolution (pixels)	Type	Digital inputs / outputs	Optical format	Pixel size (µm)	Product description
	Localization	Parts recognition	Counting	Measuring	Read code						
	■	■	■			736 x 480	EV76C541	2 + 1 external trigger / 4 + 1 ready signal	1/4"	4.5 x 4.5	CS60-BM28-EP15/300
	■	■	■	■							CS60-BM28-EP15/300ID
	■	■	■	■							CS60-BM28-EP15/400
	■	■	■	■							CS60-BM28-EP15/400ID
	■	■	■			1440 x 1080	IMX 273		CS60-BM38-EP15/300		
	■	■	■	■					CS60-BM38-EP15/300ID		
	■	■	■	■					CS60-BM38-EP15/400		
	■	■	■	■					CS60-BM38-EP15/400ID		

### Accessories for CS-60 Vision Sensors



see "CS-Z Vision sensor accessories," page 234

## CS-60 UPGRADE LICENSES

The upgrade licenses expand a CS-60 Vision Sensor with additional functions such as measurement and localization and detection (reading) of 1D and 2D codes. To activate the upgrade, the license file is simply transferred to the sensor using the nVision-i Start interface.

- The CS60-UP-ID-LICENSE expands the sensors with the functions ID Code Localization and Detection. Using the code, its x/y position can be used for updating the following tools. 1D and 2D codes are also read.
- The CS60-UP-MEAS LICENSE expands the sensor with the functions of angle measurement, circle measurement, measurement of distances from lines to lines, from points to lines and from points to points.

Technical data (typ.)	+20 °C, 24 VDC
For more information, visit	www.di-soric.com
To be used for	CS-60 Vision Sensors
Model	Upgrade

Inspection tasks	Code types 1D codes (barcodes)	Code types 2D codes	Product description	
<b>CS-60 upgrade licenses</b>				
	<ul style="list-style-type: none"> <li>■ Code 39</li> <li>■ Code 128</li> <li>■ Interleaved 2 of 5</li> <li>■ Codabar</li> <li>■ IATA 2 of 5</li> <li>■ Hong Kong 2 of 5</li> <li>■ Matrix 2 of 5</li> <li>■ NEC 2 of 5</li> <li>■ Pharmacode</li> <li>■ Straight 2 of 5</li> </ul>	<ul style="list-style-type: none"> <li>■ GS1 DataBar RSS 14,</li> <li>■ GS1 DataBar RSS 14 Stacked</li> <li>■ GS1 DataBar Limited,</li> <li>■ GS1 DataBar Expanded,</li> <li>■ GS1 DataBar Expanded Stacked</li> <li>■ UPC A</li> <li>■ UPC E</li> <li>■ EAN 8</li> <li>■ EAN 13</li> </ul>	<ul style="list-style-type: none"> <li>■ Data Matrix</li> <li>■ Aztec Code</li> <li>■ PDF 417</li> <li>■ PDF 417 Micro</li> <li>■ QR 2005</li> <li>■ QR Micro</li> <li>■ QR Model 1</li> </ul>	CS60-UP-ID-LIZENZ
	<ul style="list-style-type: none"> <li>■ Angle measurement</li> <li>■ Circle measurement</li> <li>■ Measurement of the distance between two lines</li> <li>■ Point-to-point measurement</li> <li>■ Point-to-line measurement</li> </ul>			CS60-UP-MEAS-LIZENZ

CS 60 – Standard Tool Set Localization - Detection - Counting		
+	+	+
	Measurement module	
	+	
Reading 1D/2D Codes module		
↓	↓	↓
<b>Complete modules:</b>	<b>Complete modules:</b>	<b>Complete modules:</b>
Localization	Localization	Localization
Detection	Detection	Detection
Counting	Counting	Counting
-	Measuring	Measuring
Reading 1D/2D Codes	Reading 1D/2D Codes	-



## Profile sensors

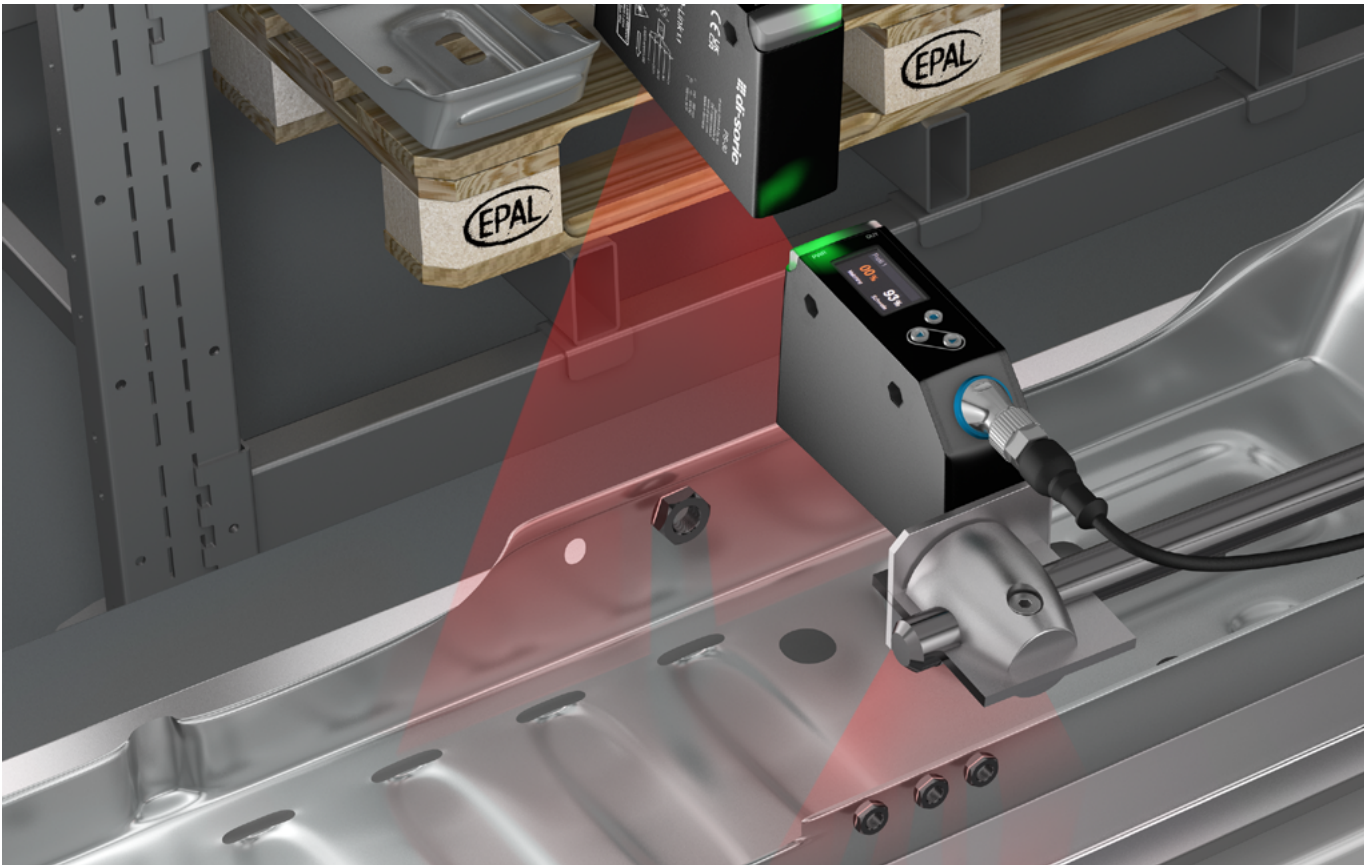

Profile sensors use the light selection method to compare the profile of checked objects with a learned target profile.

Thanks to the color and ambient light insensitivity, the smallest differences, even in nearly identical components, can also be reliably detected with alternating lighting conditions and object colors. This makes them the ideal choice for quality inspections.

## PS-30 2D LASER PROFILE SENSOR

The optoelectronic PS-30 Profile Sensor is ready to use in just a few steps and captures profiles of various objects per laser line scan. Up to 10 target profiles simplify the inspection and measurement of changing objects on the same production line. The PS-30 checks not only for the presence of an object, it also determines whether the actually intended component is used and correctly attached.

Technical data (typ.)	+20 °C, 24 VDC
Power consumption	< 200 mA
Housing dimensions H/W/D	88 / 65 / 28.5 mm
Housing material	Die-cast zinc (black)
Weight	535 g
Protection class	III, operation on protective low voltage
Storable profiles	10
Number of inputs/outputs	1 (digital) / 2 (digital)
Switching output	pnp/npn, 100 mA, NO/NC parameterizable
Interface	IO-Link V1.1, COM3
Profiles	Smart Sensor: Process Data Variable Device Identification Device Diagnosis
Light source	Laser
Light color	Red
Wavelength	650 nm
Laser class	1 (IEC 60825-1)
Ambient light immunity	20 kLx
Measuring range	150 to 300 mm
Measured value resolution	X-axis 0.25 mm, Z-axis 0.2 mm
Measuring frequency	5 Hz
Protection type	IP65
Connection	Connector, M12, 5-pin



PS-30 2D laser profile sensor		Product description
 <ul style="list-style-type: none"> <li>Creates height profiles for checking correct and complete assembly</li> <li>Quick commissioning without software</li> <li>Distance- and color-independent measurement for high tolerance in object positioning</li> <li>Ambient light immunity - no shielding or external illumination necessary</li> <li>IO-Link</li> </ul>		PS30-05LL-500-500-IBS
Accessories for the PS-30 profile sensor		
see "Accessories for image processing & identification," page 228		

## nVision Software

### The visual development environment for industrial image processing.

nVision's speed and performance capacity along with its custom adjustment options give you the right solution for your job in image processing.

The solution features a pioneering, intuitive and visually attractive user interface and reliable software.



**SOLUTIONS.  
CLEVER.  
PRACTICAL.**

nVision is the result of over 20 years of experience in the area of image processing. We are continuously developing it using modern, powerful programming languages.

By offering the nVision image processing platform, di-soric is breaking down the boundaries that previously separated traditional smart camera programming from PC high-level language programming. nVision allows intuitive graphic programming. Function blocks can be created, saved and reused.

Users appreciate the unmatched flexibility and the extremely short programming and commissioning times. Customers acquire an individually tailored software package with runtime licenses adjusted to match their individual needs.

nVision can be used in all industries – in logistics as well as medical and clinical diagnosis.

**Thanks to nVision, your projects can be implemented better and more quickly, ensuring more efficiency and profitability.**



## The easy-to-use image processing software for industry and science.

nVision is the unique and state-of-the-art culmination of 20 years of experience.

nVision is a complete and flexible solution, making it perfect for your applications in image processing as well.



### Functions

- Live data processing
- Automation of your application
- All pixel calculations either monochromatic or in color
- Barcode and Data Matrix identification
- Completeness check
- Interactive measuring
- Font recognition (OCR, OCV)
- Pattern detection
- Surface inspection
- Position detection and robot guidance
- Printed image control
- Color recognition/color processing

### Advantages

- Modern user interface
- Simple, intuitive and personalized operation
- Easy handling
- Top performance and stability
- Wide repertoire of functions
- Ensures that applications are feasible
- Less development time
- Time saving = Time to market is shortened
- Supports a wide variety of cameras
- Easy integration into automated devices
- Individualized service and support

See it for yourself and call us at:  
**+49 7181 9879 - 710**

## Handheld ID readers

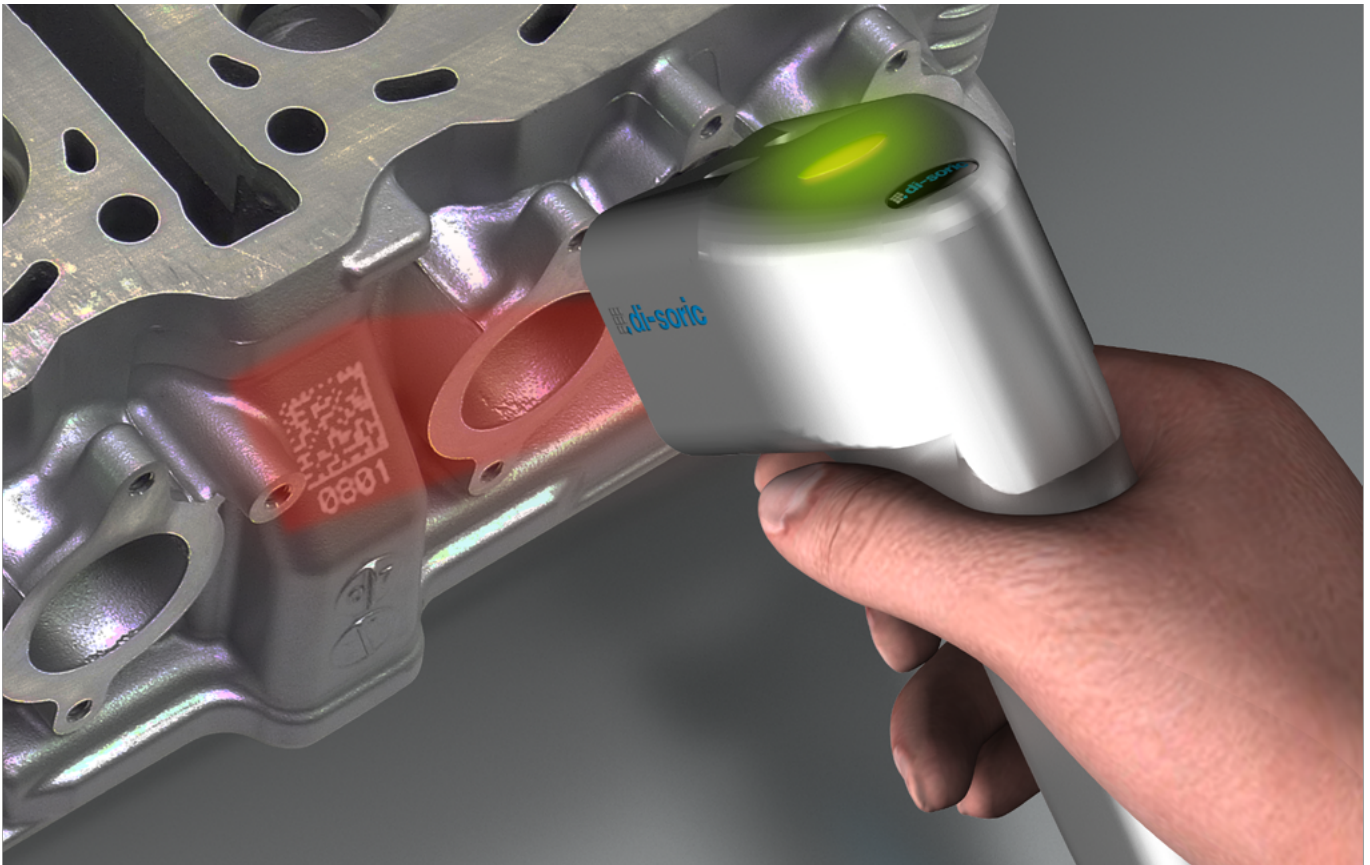

In most industries, data must be detected quickly, reliably and flexibly. In this context, the ID handheld systems from di-soric are the first choice – from the lightweight hand-reading system to the extremely robust aluminum reader. The automatic scanners read and decode 1D and 2D codes in any process environment for an accelerated, stable process.







 **di-soric**

ID-10 Compact	145
ID-80 Standard	145
ID-100 Advanced	145
ID-200 Hammer	145
ID-Z Accessories Handheld ID Reader	146

<b>Technical data (typ.)</b>	<b>+20°C, 24 VDC</b>
Image sensor	CMOS
Optics	Fixed optics
For more information, visit	www.di-soric.com









	Warranty	Target setup	ESD-capable	Resolution (pixels)	Service voltage (VDC)	Protection type	Housing material	Connection	RS 232	USB	Product description
<b>ID-10 Compact</b>											
	2-year	■		960 x 640	5.0	IP 54	Plastic	Cable	■	■	ID-10-IM3-2-US
<b>ID-80 Standard</b>											
	5-year	■		1280 x 960	5.0	IP 54	Plastic	Cable	■		ID-80-IM3-2-S
										■	ID-80-IM3-2-U
<b>ID-100 Advanced</b>											
	3-year	■		1280 x 960	5.0	IP 54	Plastic	Cable	■	■ <sup>1)</sup>	ID-100-IM3-2-US
<b>ID-200 Hammer</b>											
	3-year	■	■	1280 x 960	5.0	IP 54	Aluminum	Cable	■	■	ID-200-IM3-2-US

<sup>1)</sup>With separately available accessories

## ID-Z ACCESSORIES HANDHELD ID READER

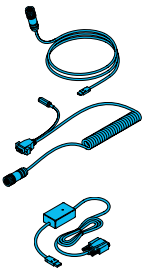
In the ID-Z accessory series, we offer the appropriate functional extensions for our Handheld ID Reader. These include brackets, cables and viewing panes.

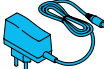
	ID-10-IM3-2-US	ID-80-IM3-2-S	ID-80-IM3-2-U	ID-100-IM3-2-US	ID-200-IM3-2-US	Designation	Note	Cable length (m)	Product description
<b>Brackets</b>									
	■					Stand	Material: Plastic		ID-10-STAND
		■	■	■		Wall bracket	Material: POM		ID-100-WBKT
					■	Wall bracket	Material: POM		ID-200-WBKT
					■	Wall bracket	Material: POM conductive ESD-Safe		ID-200-WBKT-ESD
<b>Protective cover sets</b>									
					■	ID-200 protective cover set	For the protection of the optics and lighting against contamination and damage Material: POM / glass ESD-Safe		ID-200-CVR-SET-ESD
<b>Connection cable / converter</b>									
	■	■	■	■		Connection cable	RJ50 / USB	2.4	ID-K-RJ50/U-2.4
	■	■		■		Connection cable	RJ50 / Sub-D / DC Jack	2.4	ID-K-SD/DCJ-RJ50-2
	■		■	■	■	USB converter		0.5	VSIK-K-S/U
					■	Connection cable	M12,12-pin / USB	2.0	ID-K-M12/U-2
					■	Connection cable	M12,12-pin / Sub-D/DC Jack	Coiled cord 2.0	ID-K-SD/DCJ-M12-2
					■	Connection cable	M12,12-pin / Sub-D/DC Jack	Coiled cord 5.0	ID-K-SD/DCJ-M12-5
	■	■		■	■	Serial Keyboard Converter	Serial / USB 9600 BPS German keyboard	1.8	ID-SERIALKEYBOARDCONVERT
<b>Power supply unit and energy supply</b>									
	■	■		■	■	Power supply unit	Supply voltage: 230 V Service voltage: 5V DC		ID-PS-230/5V-DCJ



## Lenses

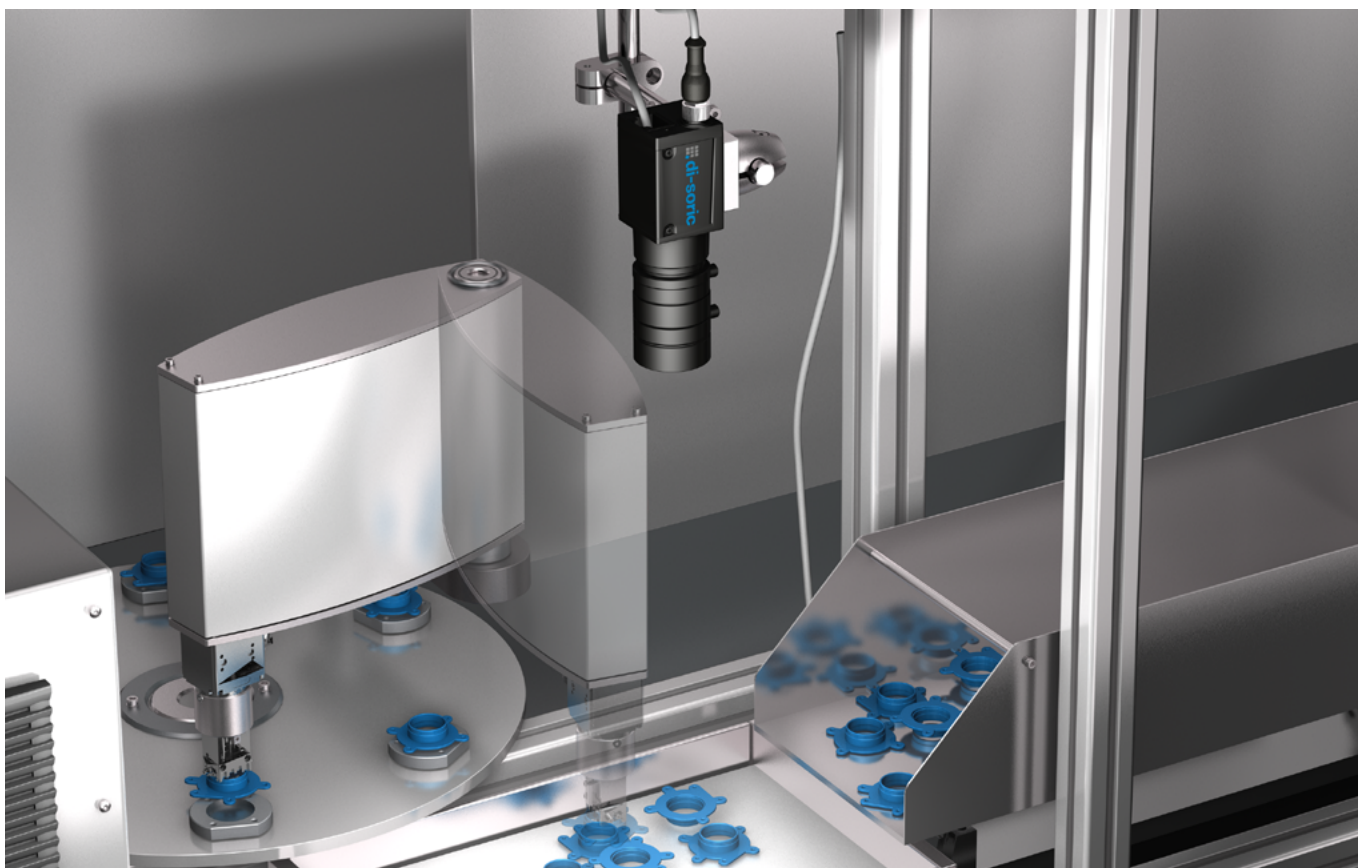

The selection of the appropriate lens is decisive for the quality of the generated image and influence variables such as measuring accuracy, freedom from errors, distortion and therefore the reliability of the subsequent evaluation. di-soric lenses are available in various designs and impress with their very robust mechanical design and the highest optical quality.



 **di-soric**

O-C lenses C-mount

149

O-S lenses S-mount

150

## O-C LENSES C-MOUNT

The lenses in the O-C series are standard lenses with a fixed focal length and represent a good value for the money. With various models with different focal lengths, this series is suited for many applications in industrial image processing. A filter thread comes standard in all models. The lenses are distinguished by low optical distortion.



### Technical data (typ.)

Threaded connection C-mount

Focal length (mm)	Aperture ratio	Aperture (F)	Distortion	Minimum Object Distance MOD (mm)	Mx filter thread Pitch P (mm)	Maximum resolution (megapixels)	Sensor size, max.	Weight (g)	Product description
<b>O-C Lenses C-mount</b>									
8	1:1.4	1.4	< 0.7%	100	M37 x 0.5	3	2/3"		0-C2-S-08-14
12	1:1.4	1.8	< -0.3%	100	M27 x 0.5	3	2/3"	73	0-C2-S-12-14
16	1:1.4	1.8	< -0.35%	100	M27 x 0.5	3	2/3"	71	0-C2-S-16-14
25	1:1.4	1.8	< -0.1%	150	M27 x 0.5	3	2/3"	60.5	0-C2-S-25-14
50	1:2.6	1.8	< -0.1%	400	M27 x 0.5	3	2/3"	60	0-C2-S-50-26
8	1:1.4	2	< -0.41%	100	M58 x 0.75	6	1/1.2"	110.8	0-C4-S-08-14
12	1:1.4	2	< 1%	100	M37.5 x 0.5	6	1/1.2"		0-C4-S-12-14
16	1:1.4	2	< 0.6%	100	M30.5 x 0.5	6	1/1.2"	106.1	0-C4-S-16-14
25	1:1.4	2	< -0.3%	200	M30.5 x 0.5	6	1/1.2"	97.3	0-C4-S-25-14
35	1:1.4	2	< -0.41%	200	M30.5 x 0.5	6	1/1.2"	94.4	0-C4-S-35-14
50	1:1.8	2	< 0.1%	200	M37.5 x 0.5	6	1/1.2"		0-C4-S-50-18
12	1:1.8	2.8	< 0.51%	100	M46 x 0.75	12	1.1"		0-C5-S-12-18/IR0
16	1:1.8	2.3	< 0.4%	100	M43 x 0.75	12	1.1"		0-C5-S-16-18/IR0
25	1:1.8	2	< 0.25%	100	M37.5 x 0.5	12	1.1"		0-C5-S-25-18/IR0

\* Changeable, threaded diaphragm plates

## O-S LENSES S-MOUNT

The lenses in the O-S series are standard lenses with a fixed focal length and represent a good value for the money. With various models with different focal lengths, this series is suited for many applications in industrial image processing. With the ability to select between the pinhole aperture 4 and 8, different depths of field can be implemented.

Technical data (typ.)	
Threaded connection	S-mount



Diameter (mm)	Wavelength	Focal length (mm)	Aperture (F)	Aperture type	Sensor size (inches)	Resolution	Working distance	Temperature resistance	Product description
<b>O-S Lenses S-Mount for CS-60</b>									
14	400 to 950 nm	3.6	4.0	Fixed	1/2.5	5 MP	endless	-20 to +60 °C	0-S1-S-036-40
		3.6	8.0	Fixed	1/2.5	5 MP			0-S1-S-036-80
		8	4.0	Fixed	1/3	1 MP			0-S1-S-080-40
		8	8.0	Fixed	1/3	1 MP			0-S1-S-080-80
		16	4.0	Fixed	1/3	1 MP			0-S1-S-160-40
		16	8.0	Fixed	1/3	1 MP			0-S1-S-160-80
		25	4.0	Fixed	1/2	3 MP			0-S1-S-250-40
		25	8.0	Fixed	1/2	3 MP			0-S1-S-250-80

**Accessories** for lenses

see "O-Z Filters, spacer rings and converters," page 229





## Lighting for industrial image processing

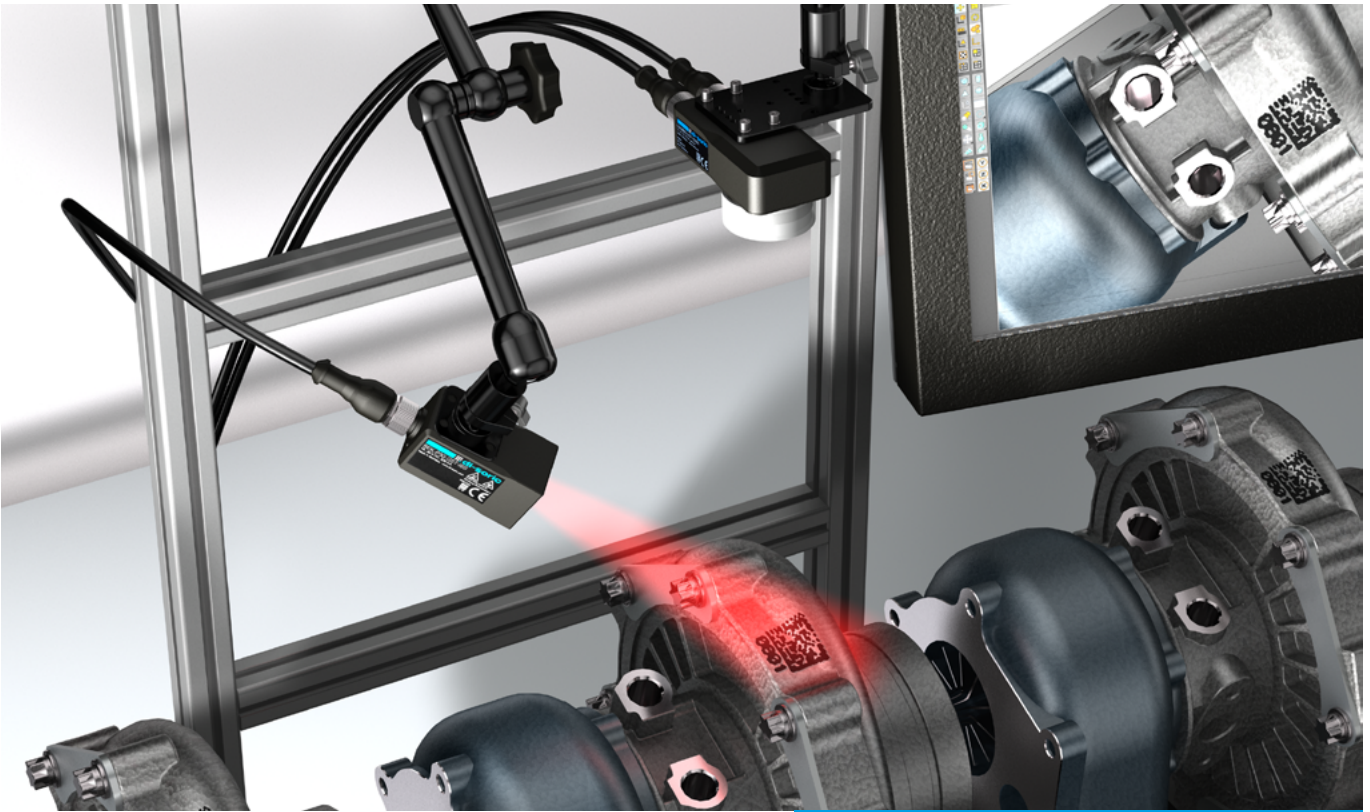

These lighting systems are used for contrast amplification in image-processing applications. The product range includes solutions for an extremely wide range of lighting scenarios, including area, bar, spot, ring, coaxial, dark field and dome lighting systems. The products are distinguished by various color temperatures, a high protection type, load-free trigger and trigger inversion.



BE-F Area lights	153
BE-B Barlights	155
BE-P Spotlights	158
BE-R Ringlights	159
BE-K Coaxial lights	161
BE-D Dark field lights	162
Customized lighting	163



## BE-F AREA LIGHTS

Area lights with switchable constant light are suited for operation using a 24 V DC voltage source. They offer a constant light intensity across a wide voltage range.

Technical data (typ.)	+20 °C, 24 VDC
Trigger input low level	0 to < 2.8 V
Trigger input high level	> 3.3 to 35 V
Plug connector	M12
Connection cable	VK... (optionally available)



	Illuminated area (mm)	Deflection angle (°)	Size / housing design (mm)	Service voltage (VDC)	Ambient temperature (°C)	Integrated control of power output	Light intensity can be adjusted	Trigger	Protection type	Housing material	Light color	Product description
<b>BE-F Area lights with switchable constant light</b>												
	30 x 30	–	30 x 30 x 20	24	0 to +40				IP 67	Aluminum Black Anodized	<input checked="" type="checkbox"/> Red <input type="checkbox"/> White	BE-F30/30RL-G1-K-BS BE-F30/30RL-G5-K-BS
	50 x 50	–	50 x 50 x 20	24	0 to +40				IP 67	Aluminum Black Anodized	<input checked="" type="checkbox"/> Red <input type="checkbox"/> White	BE-F50/50RL-G1-K-BS BE-F50/50RL-G5-K-BS
	50 x 50	–	80 x 110 x 15	15 to 35	0 to +50	■	■	■	IP 67	Aluminum Black Anodized	<input checked="" type="checkbox"/> Infrared	BEK-F50/50-G0TI-IBS
				15 to 35							<input checked="" type="checkbox"/> Red	BEK-F50/50-G1TI-IBS
				18 to 35							<input checked="" type="checkbox"/> Green	BEK-F50/50-G2TI-IBS
				18 to 35							<input checked="" type="checkbox"/> Blue	BEK-F50/50-G3TI-IBS
				18 to 35							<input type="checkbox"/> White	BEK-F50/50-G5TI-IBS
	100 x 100	–	130 x 160 x 15	15 to 35	0 to +50	■	■	■	IP 67	Aluminum Black Anodized	<input checked="" type="checkbox"/> Infrared	BEK-F100/100-G0TI-IBS
				15 to 35							<input checked="" type="checkbox"/> Red	BEK-F100/100-G1TI-IBS
				18 to 35							<input checked="" type="checkbox"/> Green	BEK-F100/100-G2TI-IBS
				18 to 35							<input checked="" type="checkbox"/> Blue	BEK-F100/100-G3TI-IBS
				18 to 35							<input type="checkbox"/> White	BEK-F100/100-G5TI-IBS
	150 x 150	–	180 x 210 x 15	15 to 35	0 to +50	■	■	■	IP 67	Aluminum Black Anodized	<input checked="" type="checkbox"/> Infrared	BEK-F150/150-G0TI-IBS
				15 to 35							<input checked="" type="checkbox"/> Red	BEK-F150/150-G1TI-IBS
18 to 35				<input checked="" type="checkbox"/> Green							BEK-F150/150-G2TI-IBS	
18 to 35				<input checked="" type="checkbox"/> Blue							BEK-F150/150-G3TI-IBS	
18 to 35				<input type="checkbox"/> White							BEK-F150/150-G5TI-IBS	
200 x 200	–	230 x 260 x 18	15 to 35	0 to +50	■	■	■	IP 67	Aluminum Black Anodized	<input checked="" type="checkbox"/> Infrared	BEK-F200/200-G0TI-IBS	
			15 to 35							<input checked="" type="checkbox"/> Red	BEK-F200/200-G1TI-IBS	
			18 to 35							<input checked="" type="checkbox"/> Green	BEK-F200/200-G2TI-IBS	
			18 to 35							<input checked="" type="checkbox"/> Blue	BEK-F200/200-G3TI-IBS	
			18 to 35							<input type="checkbox"/> White	BEK-F200/200-G5TI-IBS	
	250 x 250	–	317 x 317 x 23	24	0 to +40				IP 67	Aluminum Black Anodized	<input checked="" type="checkbox"/> Red <input type="checkbox"/> White	BEK-FL250/250-G1TI-IBS BEK-FL250/250-G5TI-IBS
	250 x 250	–	317 x 317 x 23	24	0 to +40				IP 20	Aluminum Black Anodized	<input type="checkbox"/> White	BEK-FL250/250-R50-G5TI-IBS

	Illuminated area (mm)	Deflection angle (°)	Size / housing design (mm)	Service voltage (VDC)	Ambient temperature (°C)	Integrated control of power output	Light intensity can be adjusted	Trigger	Protection type	Housing material	Light color	Product description
<b>BE-F Area lights with switchable constant light</b>												
	400 x 400	–	467 x 467 x 23	24	0 to +40				IP 67	Aluminum Black Anodized	<input checked="" type="checkbox"/> Red <input type="checkbox"/> White	BEK-FL400/400-G1T-IBS BEK-FL400/400-G5T-IBS
	400 x 400	–	467 x 467 x 23	24	0 to +40				IP 20	Aluminum Black Anodized	<input type="checkbox"/> White	BEK-FL400/400-R50-G5T-IBS

Externally flashable area lights are suited for operation using a constant current source or a flash controller. They are the ideal solution for very short camera exposure times and therefore for extremely high-speed processes.

Technical data (typ.)	+20 °C, 24 VDC
Service voltage	Operation exclusively with flash controller
Risk group	Open (DIN EN 62471)
Protection class	III, operation on protective low voltage
Shock/vibration load	30 g / 10 – 55 Hz, 1 mm
Ambient temperature	0 to +50 °C
Insulation voltage endurance	500 V
Housing material	Aluminum, black anodized
Connection	Cable PUR 2.5 m



	Illuminated area/length (mm)	Deflection angle (°)	Size / housing design (mm)	Ambient temperature (°C)	Pulse power consumption (W)	Pulse overload factor	Pulse current-carrying capacity (mA)	Protection type	Window material	Window	Light color	Product description
<b>BE-F Area lights, externally flashable</b>												
	50 x 50	–	80 x 80 x 13	0 to 50	Max. 135	Max. 18	Max. 6,400	IP 67	PC, opal	Diffuse	<input checked="" type="checkbox"/> Infrared	BE-F50/50-F0-K
					Max. 25	Max. 6.4	Max. 1,600				<input checked="" type="checkbox"/> Red	BE-F50/50-F1-K
					Max. 40	Max. 8	Max. 1,600				<input type="checkbox"/> White	BE-F50/50-F5-K
	100 x 100	–	130 x 130 x 13	0 to 50	Max. 275	Max. 18	Max. 12,800	IP 67	PC, opal	Diffuse	<input checked="" type="checkbox"/> Infrared	BE-F100/100-F0-K
					Max. 48	Max. 6.4	Max. 3,200				<input checked="" type="checkbox"/> Red	BE-F100/100-F1-K
					Max. 80	Max. 9	Max. 3,200				<input type="checkbox"/> White	BE-F100/100-F5-K
	150 x 150	–	180 x 180 x 13	0 to 50	Max. 460	Max. 19	Max. 19,200	IP 67	PC, opal	Diffuse	<input checked="" type="checkbox"/> Infrared	BE-F150/150-F0-K
					Max. 80	Max. 6.6	Max. 4,800				<input checked="" type="checkbox"/> Red	BE-F150/150-F1-K
					Max. 125	Max. 9.6	Max. 4,800				<input type="checkbox"/> White	BE-F150/150-F5-K
	200 x 200	–	230 x 230 x 13	0 to 50	Max. 500	Max. 18	Max. 19,900	IP 67	PC, opal	Diffuse	<input checked="" type="checkbox"/> Infrared	BE-F200/200-F0-K
					Max. 120	Max. 9	Max. 6,400				<input checked="" type="checkbox"/> Red	BE-F200/200-F1-K
					Max. 180	Max. 9	Max. 6,400				<input type="checkbox"/> White	BE-F200/200-F5-K

## BE-B BARLIGHTS

Barlights with switchable constant light are suited for operation using a 24 V DC voltage source. They offer a constant light intensity across a wide voltage range.

Technical data (typ.)	+20 °C, 24 VDC
Trigger input low level	0 to < 2.8 V
Trigger input high level	> 3.3 to 35 V
Shock/vibration load	30 g / 10 – 55 Hz, 1 mm
Plug connector	M12
Connection cable	VK... (optionally available)



	Illuminated area / length (mm)	Deflection angle (°)	Size / housing design (mm)	Service voltage (VDC)	Ambient temperature (°C)	Integrated control or power output	Trigger	Protection type	Housing material	Light color	Product description
<b>BE-B Barlights with switchable constant light</b>											
	30 x 30	–	30 x 30 x 20	24	0 to +40			IP 67	Aluminum Black Anodized	<input checked="" type="checkbox"/> Red <input type="checkbox"/> White	BE-A30/30-G1-K-BS BE-A30/30-G5-K-BS
	50 x 50	–	50 x 50 x 20	24	0 to +40			IP 67	Aluminum Black Anodized	<input checked="" type="checkbox"/> Red <input type="checkbox"/> White	BE-A50/50-G1-K-BS BE-A50/50-G5-K-BS
	16 x 65	18°	16 x 20 x 84	24	0 to +40			IP 40	Aluminum Black Anodized	<input checked="" type="checkbox"/> Infrared <input checked="" type="checkbox"/> Red <input checked="" type="checkbox"/> Blue <input type="checkbox"/> White	BE-A65-G0-K-BS BE-A65-G1-K-BS BE-A65-G3-K-BS BE-A65-G5-K-BS
	16 x 130	18°	16 x 20 x 144	24	0 to +40			IP 40	Aluminum Black Anodized	<input checked="" type="checkbox"/> Infrared <input checked="" type="checkbox"/> Red <input checked="" type="checkbox"/> Blue <input type="checkbox"/> White	BE-A130-G0-K-BS BE-A130-G1-K-BS BE-A130-G3-K-BS BE-A130-G5-K-BS
	16 x 240	18°	16 x 20 x 254	24	0 to +40			IP 40	Aluminum Black Anodized	<input checked="" type="checkbox"/> Infrared <input checked="" type="checkbox"/> Red <input checked="" type="checkbox"/> Blue <input type="checkbox"/> White	BE-A240-G0-K-BS BE-A240-G1-K-BS BE-A240-G3-K-BS BE-A240-G5-K-BS

	Illuminated area / length (mm)	Deflection angle (°)	Size / housing design (mm)	Service voltage (V DC)	Ambient temperature (°C)	Integrated control of power output	Trigger	Protection type	Housing material	Light color	Product description
	96 x 23	30°	40 x 60 x 113	18 to 30	0 to +40	■	■	IP 67	Aluminum Black Anodized	 Infrared	BEK-A100-G0T-K-BS
										 Red	BEK-A100-G1T-K-BS
										 Green	BEK-A100-G2T-K-BS
										 Blue	BEK-A100-G3T-K-BS
										 White	BEK-A100-G5T-K-BS
	196 x 23	30°	40 x 60 x 213	18 to 30	0 to +40	■	■	IP 67	Aluminum Black Anodized	 Red	BEK-A200-G1T-K-BS
	296 x 23	30°	40 x 60 x 313	18 to 30	0 to +40	■	■	IP 67	Aluminum Black Anodized	 Infrared	BEK-A300-G0T-K-BS
										 Red	BEK-A300-G1T-K-BS
										 Green	BEK-A300-G2T-K-BS
										 Blue	BEK-A300-G3T-K-BS
										 White	BEK-A300-G5T-K-BS
	396 x 23	30°	40 x 60 x 413	18 to 30	0 to +40	■	■	IP 67	Aluminum Black Anodized	 Infrared	BEK-A400-G0T-K-BS
										 Red	BEK-A400-G1T-K-BS
										 White	BEK-A400-G5T-K-BS
	496 x 23	30°	40 x 60 x 513	18 to 30	0 to +40	■	■	IP 67	Aluminum Black Anodized	 Infrared	BEK-A500-G0T-K-BS
										 Red	BEK-A500-G1T-K-BS
										 White	BEK-A500-G5T-K-BS

Externally flashable barlights are suited for operation using a constant current source or a flash controller. They are the ideal solution for very short camera exposure times and therefore for extremely high-speed processes.



Technical data (typ.)	+20 °C, 24 VDC
Service voltage	Operation exclusively with flash controller
Risk group	Open (DIN EN 62471)
Protection class	III, operation on protective low voltage
Shock/vibration load	30 g / 10 – 55 Hz, 1 mm
Ambient temperature	0 to +50 °C
Insulation voltage endurance	500 V
Housing material	Aluminum, black anodized
Connection	Cable PUR 2.5 m

	Illuminated area/length (mm)	Deflection angle (°)	Size / housing design (mm)	Ambient temperature (°C)	Pulse power consumption (W)	Pulse overload factor	Pulse current-carrying capacity (mA)	Protection type	Window material	Window	Light color	Product description
<b>BE-B Barlights, externally flashable</b>												
	46 x 95	-	60 x 40 x 113	0 to 40	290	9.33	20,000	IP 67	PMMA	Clear	Infrared	BE-A100-F0-K
					240	8.0	8,000				Red	BE-A100-F1-K
					250	8.0	8,000				White	BE-A100-F5-K
	46 x 295	-	60 x 40 x 313	0 to 40	1,500	24	60,000	IP 67	PMMA	Clear	Infrared	BE-A300-F0-K
					720	12	24,000				Red	BE-A300-F1-K
					750	12	24,000				White	BE-A300-F5-K

**Accessories for BE-A 100 ... / BE-A 300 ...**

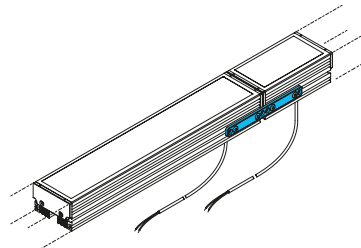
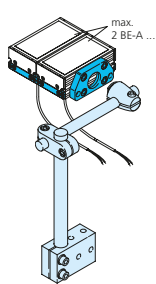

see "BE-Z BV lighting accessories," page 231

## BE-P SPOTLIGHTS

Spotlights with switchable constant light are suited for operation using a 24 V DC voltage source. They offer a constant light intensity over a wide voltage range and are distinguished by features such as trigger inversion and brightness adjustment.

Technical data (typ.)	+20 °C, 24 VDC
Trigger input low level	0 to < 2.8 V
Trigger input high level	> 3.3 to 35 V
Shock/vibration load	30 g / 10 – 55 Hz, 1 mm
Plug connector	M12
Connection cable	VK... (optionally available)



	Illuminated area (mm)	Deflection angle (°)	Size / housing design (mm)	Service voltage (VDC)	Ambient temperature (°C)	Integrated control of power output	Trigger	Protection type	Housing material	Light color	Product description
<b>BE-P Spotlights with switchable constant light</b>											
		25°	M12 x 71	10 to 30	0 to +40	■	■	IP 67	Brass nickel-plated	<input checked="" type="checkbox"/> Red <input type="checkbox"/> White	BEK-PM12-G1T-BS BEK-PM12-G5T-BS
	Ø21	7°	30 x 32 x 60	18 to 30	0 to +40	■	■	IP 67	Aluminum black anodized	<input checked="" type="checkbox"/> Red <input checked="" type="checkbox"/> Blue <input type="checkbox"/> White	BEK-P7-G1T-IBS BEK-P7-G3T-IBS BEK-P7-G5T-IBS
	Ø21	10°	30 x 32 x 60	18 to 30	0 to +40	■	■	IP 67	Aluminum black anodized	UV light	BEK 1-P14-G7TI-IBS
	Ø21	14°	30 x 32 x 60	18 to 30	0 to +40	■	■	IP 67	Aluminum black anodized	<input checked="" type="checkbox"/> Infrared <input checked="" type="checkbox"/> Red <input checked="" type="checkbox"/> Blue <input type="checkbox"/> White UV light	BEK-P14-G0TI-IBS BEK-P14-G1TI-IBS BEK-P14-G3TI-IBS BEK-P14-G5TI-IBS BEK-P14-G7TI-IBS
	Ø21	25°	30 x 32 x 60	18 to 30	0 to +40	■	■	IP 67	Aluminum black anodized	UV light	BEK-P25-G7TI-IBS
	Ø21	30°	30 x 32 x 60	18 to 30	0 to +40	■	■	IP 67	Aluminum black anodized	<input checked="" type="checkbox"/> Infrared <input checked="" type="checkbox"/> Red <input checked="" type="checkbox"/> Blue <input type="checkbox"/> White	BEK-P30-G0TI-IBS BEK-P30-G1TI-IBS BEK-P30-G3TI-IBS BEK-P30-G5TI-IBS



## BE-R RINGLIGHTS

Ringlights with switchable constant light are suited for operation using a 24 V DC voltage source. They offer a constant light intensity over a wide voltage range and are distinguished by features such as trigger inversion and brightness adjustment.

### Technical data (typ.)

**+20 °C, 24 VDC**

Trigger input low level	0 to < 2.8 V
Trigger input high level	> 3.3 to 35 V
Shock/vibration load	30 g / 10 – 55 Hz, 1 mm
Plug connector	M12
Connection cable	VK... (optionally available)



	Illuminated area (mm)	Deflection angle (°)	Size / housing design (mm)	Service voltage (VDC)	Ambient temperature (°C)	Integrated control of power output	Light intensity can be adjusted	Trigger	Protection type	Housing material	Light color	Product description	
<b>BE-R Ringlights with switchable constant light</b>													
	Ø 30	90°	Ø 69x20	24	0 to +40				IP 67	Aluminum Black Anodized	Infrared	BE-R30-G0-K-BS-CLR <sup>1)</sup>	
											Infrared	BE-R30-G0-K-BS-DIF <sup>2)</sup>	
											Red	BE-R30-G1-K-BS-CLR <sup>1)</sup>	
	Ø 30	80°	Ø 69x20	24	0 to +40					IP 67	Aluminum Black Anodized	Red	BE-R30-G1-K-BS-DIF <sup>2)</sup>
												Red	BE-R30-G1-K-BS-POL <sup>3)</sup>
												White	BE-R30-G5-K-BS-CLR <sup>1)</sup>
	Ø 30	80°	Ø 69x20	24	0 to +40					IP 67	Aluminum Black Anodized	White	BE-R30-G5-K-BS-DIF <sup>2)</sup>
												White	BE-R30-G5-K-BS-POL <sup>3)</sup>
	Ø 70	30°	Ø 130x29	18 to 35	0 to +40	■	■	■	IP 67	Aluminum Black Anodized	Infrared	BEK-R70/30-G0TI-IBS-CLR <sup>1)</sup>	
											Infrared	BEK-R70/30-G0TI-IBS-DIF <sup>2)</sup>	
	Ø 70	30°	Ø 130x29	18 to 35	0 to +40	■	■	■	IP 67	Aluminum Black Anodized	Red	BEK-R70/30-G1TI-IBS-CLR <sup>1)</sup>	
											Red	BEK-R70/30-G1TI-IBS-DIF <sup>2)</sup>	
	Ø 70	20°	Ø 130x29	18 to 35	0 to +40	■	■	■	IP 67	Aluminum Black Anodized	Green	BEK-R70/20-G2TI-IBS-CLR <sup>1)</sup>	
											Green	BEK-R70/20-G2TI-IBS-DIF <sup>2)</sup>	
	Ø 70	20°	Ø 130x29	18 to 35	0 to +40	■	■	■	IP 67	Aluminum Black Anodized	Green	BEK-R70/20-G2TI-IBS-POL <sup>3)</sup>	
											Blue	BEK-R70/20-G3TI-IBS-CLR <sup>1)</sup>	
	Ø 70	20°	Ø 130x29	18 to 35	0 to +40	■	■	■	IP 67	Aluminum Black Anodized	Blue	BEK-R70/20-G3TI-IBS-DIF <sup>2)</sup>	
											Blue	BEK-R70/20-G3TI-IBS-POL <sup>3)</sup>	
Ø 70	120°	Ø 130x29	18 to 35	0 to +40	■	■	■	IP 67	Aluminum Black Anodized	White	BEK-R70/120-G5TI-IBS-CLR <sup>1)</sup>		
										White	BEK-R70/120-G5TI-IBS-DIF <sup>2)</sup>		
										White	BEK-R70/120-G5TI-IBS-POL <sup>3)</sup>		

<sup>1)</sup> Clear safety screen

<sup>2)</sup> Diffuser panel

<sup>3)</sup> Polarizer panel

Externally flashable ringlights are suited for operation using a constant current source or a flash controller. They are the ideal solution for very short camera exposure times and therefore for extremely high-speed processes.



Technical data (typ.)	+20 °C, 24 VDC
Service voltage	Operation exclusively with flash controller
Risk group	Open (DIN EN 62471)
Protection class	III, operation on protective low voltage
Shock/vibration load	30 g / 10 – 55 Hz, 1 mm
Ambient temperature	0 to +50 °C
Insulation voltage endurance	500 V
Housing material	Aluminum, black anodized
Connection	Cable PUR 2.5 m

	Illuminated area/length (mm)	Deflection angle (°)	Size / housing design (mm)	Ambient temperature (°C)	Pulse power consumption (W)	Pulse overload factor	Pulse current-carrying capacity (mA)	Protection type	Window material	Window	Light color	Product description
	Ø 30	30°	Ø 69x20	0 to 40	Max. 30	8	Max. 2,000	IP 67	PMMA	Clear	■ Red	BE-R30-F1-K-CLR
										Diffuse	■ Red	BE-R30-F1-K-DIF
										Polarized	■ Red	BE-R30-F1-K-POL
	Ø 30	120°	Ø 69x20	0 to 40	Max. 45	10	Max. 2,000	IP 67	PMMA	Clear	□ White	BE-R30-F5-K-CLR
										Diffuse	□ White	BE-R30-F5-K-DIF
										Polarized	□ White	BE-R30-F5-K-POL
	Ø 70	30°	Ø 130x20	0 to 40	Max. 96	8	Max. 6,000	IP 67	PMMA	Clear	■ Red	BE-R70-F1-K-CLR
										Diffuse	■ Red	BE-R70-F1-K-DIF
										Polarized	■ Red	BE-R70-F1-K-POL
	Ø 70	120°	Ø 130x20	0 to 40	Max. 140	10	Max. 6,000	IP 67	PMMA	Clear	□ White	BE-R70-F5-K-CLR
										Diffuse	□ White	BE-R70-F5-K-DIF
										Polarized	□ White	BE-R70-F5-K-POL
	Ø 130	30°	Ø 200x20	0 to 40	Max. 230	8	Max. 12,000	IP 67	PMMA	Clear	■ Red	BE-R130-F1-K-CLR
										Diffuse	■ Red	BE-R130-F1-K-DIF
										Polarized	■ Red	BE-R130-F1-K-POL
	Ø 130	120°	Ø 200x20	0 to 40	Max. 275	10	Max. 11,000	IP 67	PMMA	Clear	□ White	BE-R130-F5-K-CLR
										Diffuse	□ White	BE-R130-F5-K-DIF
										Polarized	□ White	BE-R130-F5-K-POL

Accessories for ringlights

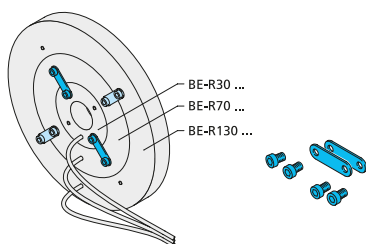

see "BE-Z BV lighting accessories," page 231

## BE-K COAXIAL LIGHTS

Coaxial lights are used for shadow-free, axial illumination of the object examined. Surface reflections are reliably suppressed. They are available in all application-relevant light colors and are distinguished by features such as trigger inversion and brightness adjustment.

Coaxial lights are suited for operation using a 24 VDC voltage source and are brightness-stabilized for a wide voltage range.



Technical data (typ.)	+20 °C, 24 VDC
Trigger input low level	0 to < 2.8 V
Trigger input high level	> 3.3 to 35 V
Shock/vibration load	30 g / 10 – 55 Hz, 1 mm
Plug connector	M12
Connection cable	VK... (optionally available)



	Illuminated area (mm)	Deflection angle (°)	Size / housing design (mm)	Service voltage (VDC)	Ambient temperature (°C)	Integrated control of power output	Light intensity can be adjusted	Trigger	Protection type	Housing material	Light color	Product description
<b>BE-K Coaxial lights</b>												
	50 x 50	–	62 x 58 x 103.5	18 to 35	0 to +40	■	■	■	IP 20	Aluminum Black Anodized	<div style="display: flex; flex-direction: column; gap: 5px;"> <div><span style="color: red;">■</span> Red</div> <div><span style="color: green;">■</span> Green</div> <div><span style="color: blue;">■</span> Blue</div> <div><span style="color: white;">□</span> White</div> </div>	<div style="display: flex; flex-direction: column; gap: 5px;"> <div>BEK-K50/50-G1TI-IBS</div> <div>BEK-K50/50-G2TI-IBS</div> <div>BEK-K50/50-G3TI-IBS</div> <div>BEK-K50/50-G5TI-IBS</div> </div>

## BE-D DARK FIELD LIGHTS

Dark field lights are used for the contrast enhancement of surface defects, for example for quality control. In these lighting systems, light is injected transversely to the camera's viewing direction. They are available in all application-relevant light colors and are distinguished by features such as trigger inversion and brightness adjustment.

Technical data (typ.)	+20 °C, 24 VDC
Trigger input low level	0 to < 2.8 V
Trigger input high level	> 3.3 to 35 V
Shock/vibration load	30g/10–55Hz, 1 mm
Plug connector	M12
Connection cable	VK... (optionally available)



	Illuminated area (mm)	Deflection angle (°)	Size / housing design (mm)	Service voltage (VDC)	Ambient temperature (°C)	Integrated control of power output	Light intensity can be adjusted	Trigger	Protection type	Housing material	Light color	Product description
<b>BE-D Dark field lights</b>												
	Ø 70	–	95 x 130 x 12	10 to 35	0 to +40	■	■	■	IP 67	Aluminum Black Anodized	■ Infrared ■ Red ■ Green ■ Blue □ White	BEK-D70-G0TI-K-BS BEK-D70-G1TI-K-BS BEK-D70-G2TI-K-BS BEK-D70-G3TI-K-BS BEK-D70-G5TI-K-BS
	Ø 120	–	170 x 200 x 15	10 to 35	0 to +50	■	■	■	IP 67	Aluminum Black Anodized	■ Infrared ■ Red ■ Green ■ Blue □ White	BEK 1-D120-G0TI-IBS BEK 1-D120-G1TI-IBS BEK 1-D120-G2TI-IBS BEK 1-D120-G3TI-IBS BEK 1-D120-G5TI-IBS

## CUSTOMIZED LIGHTING



We will review special requirements related to size and design, light color and connectivity together with you and, upon request, we will implement small production runs of customized products.



Does your application have limited installation space available?

Do you require special lighting for image processing?

Are the standard devices from our product line unable to meet the special requirements of your application needs?

Our special customer-specific lights give you a cost-effective option for meeting the particular needs of your application.

With our custom lights, you can achieve maximum process reliability for your specific image processing application.

And all this at the usual highest di-soric level of quality.



**Challenge us. We work together with you.**

## Machine & signal lighting

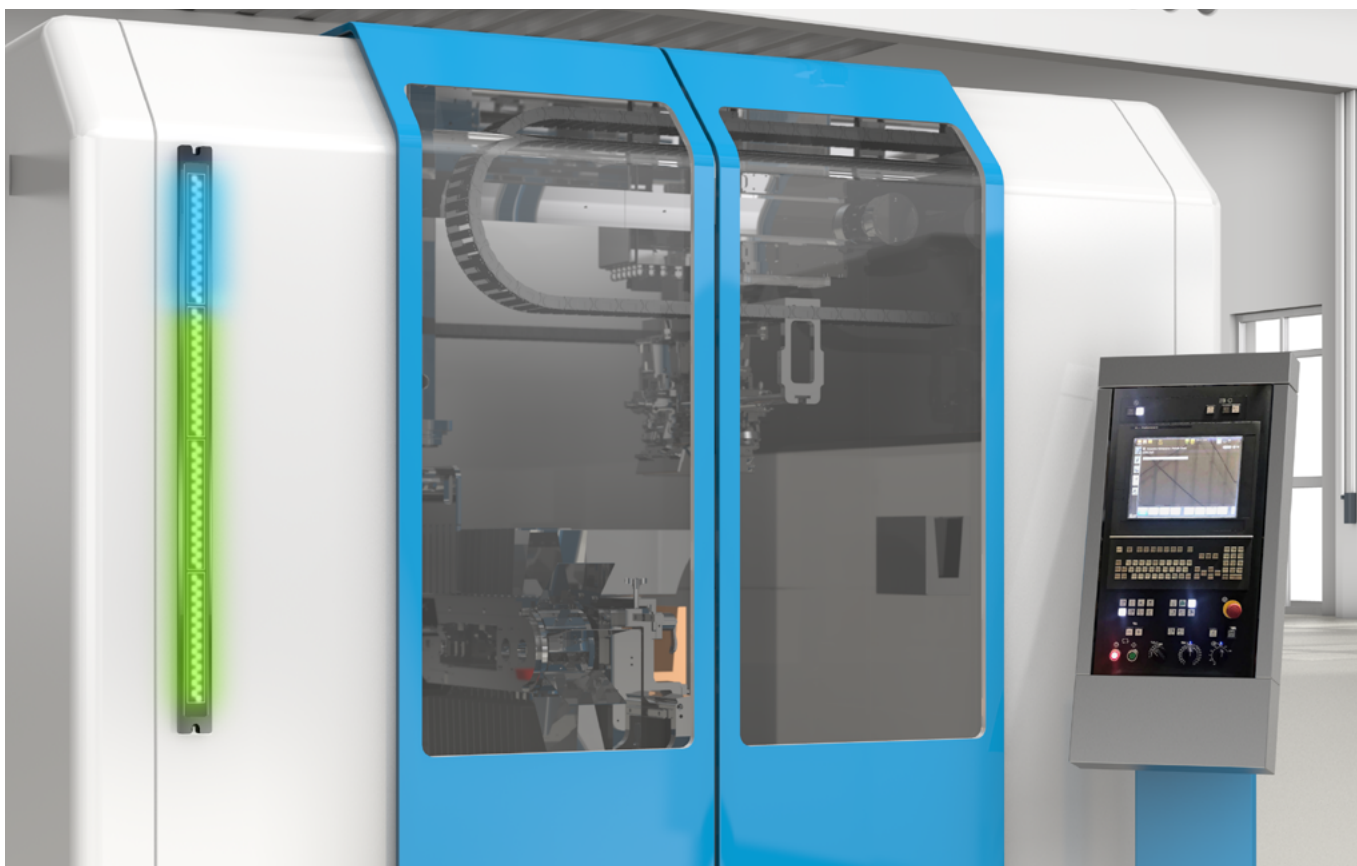

The compact, easily integratable machine and signal lighting enables illumination of machines with the highest light quality and distinguish themselves through their robust, industry-quality construction. A large selection of overall lengths is available for individual requirements.

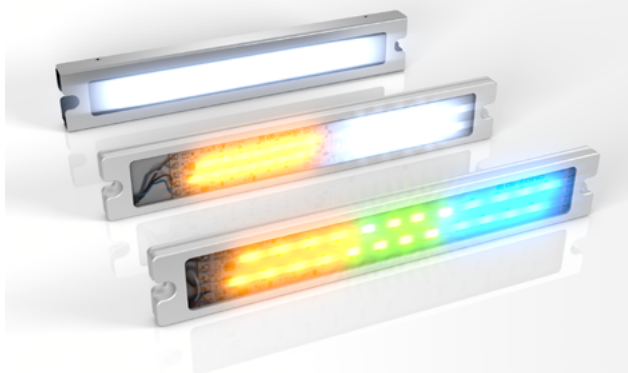

 **di-soric**

MB-R Machine lighting semicircular	165
MB-N Machine lighting flat	165
MB-NP Protected machine lighting	166
MB-RGBW Machine lighting with status indicator	166
SB-RGB Multi-Segment IOL signal lighting	167

## MB-R MACHINE LIGHTING SEMICIRCULAR

This robust, semicircle machine lighting is ideal for use in machines or in rough production environments due to its expanded temperature range, modern plug connection technology and hardened safety glass. The neutral white light ensures pleasant lighting conditions.



Technical data (typ.)	+20 °C
Service voltage	24 VDC (Supply Class 2)
Light color	5,000 K white (LED)
Ambient temperature	-20 to 50 °C
Protection type	IP 67
Housing material	Aluminum, natural anodized
Connection	Connector, M12, 5-pin
Connection cable	VK... (optionally available)

	Illuminated area (mm)	No-load current at 24 V	Power draw at 24 V	Light intensity at 0.5 m	Light intensity at 1.0 m	Luminous flux	Weight (excluding packaging)	Product description
<b>MB-R semi-circle machine lighting</b>								
	150 x 23.5	180mA	4.3 W	310lx	85lx	210lm	340 g	MB-R-190-B5
	240 x 23.5	255mA	6.1 W	470lx	120lx	285lm	460 g	MB-R-280-B5
	325 x 23.5	335mA	8 W	600lx	155lx	450lm	570 g	MB-R-365-B5
	500 x 23.5	650mA	15.6 W	840lx	260lx	980lm	800 g	MB-R-540-B5
	675 x 23.5	1000mA	24 W	1540lx	480lx	1560lm	1030 g	MB-R-715-B5
	1000 x 23.5	1180mA	28.3 W	1580lx	520lx	1690lm	1450 g	MB-R-1040-B5
	1500 x 23.5	1590mA	38.2 W	1570lx	610lx	2600lm	2110 g	MB-R-1540-B5

## MB-N MACHINE LIGHTING FLAT

The MB-N machine lighting has a compact design and feature load-free triggers. They offer the highest light quality in white, which meets the strictest requirements.



Technical data (typ.)	+20 °C
Service voltage	24 VDC (Supply Class 2)
Light color	5,000 K white (LED)
Ambient temperature	-20 to 40 °C
Protection type	IP 67
Housing material	Aluminum, natural anodized
Connection cable	VK... (optionally available)

	Illuminated area (mm)	No-load current at 24 V	Power draw at 24 V	Light intensity at 0.5 m	Light intensity at 1.0 m	Luminous flux	Cable 300 mm, M12, 3-pin	Cable 3,000 mm, flying leads	Weight (excluding packaging)	Product description
<b>MB-N Machine lighting flat</b>										
	95 x 30	190mA	4.6 W	720lx	220lx	440lm	■	■	115 g	MB-N-126-K-B3
									175 g	MB-N-126-K
	220 x 30	450mA	10.8 W	1800lx	530lx	1100lm	■	■	210 g	MB-N-251-K-B3
									260 g	MB-N-251-K
	440 x 30	900mA	21.6 W	3200lx	1000lx	2200lm	■	■	390 g	MB-N-481-K-B3
									440 g	MB-N-481-K
	660 x 30	1350mA	32.4 W	3900lx	1300lx	3300lm	■	■	550 g	MB-N-701-K-B3
								600 g	MB-N-701-K	
870 x 30	1800mA	43.2 W	4400lx	1600lx	4400lm	■	■	700 g	MB-N-911-K-B3	
								750 g	MB-N-911-K	

## MB-NP PROTECTED MACHINE LIGHTING

The compact MB-NP Protected machine lighting impress with their high degree of robustness in the face of rough ambient conditions. This machine lighting from di-soric withstand a large number of chemically aggressive cutting and drilling fluids and are protected against cuttings. As a feature, they have load-free triggers and offer the highest light quality in white, which meets the strictest requirements.



Technical data (typ.)	+20 °C
Service voltage	24 VDC (Supply Class 2)
Light color	5,000 K white (LED)
Ambient temperature	0 to 40 °C
Protection type	IP 67
Housing material	Aluminum, natural anodized

	Illuminated area (mm)	No-load current at 24 V	Power draw at 24 V	Light intensity at 0.5 m	Light intensity at 1.0 m		Cable 3,000 mm, flying leads	Weight (excluding packaging)	Product description
<b>MB-NP Protected</b> for use in corrosive environments									
	30 x 220	450 mA	10.8 W	1,400lx	430lx		■	410 g	MB-NP-250-K
	30 x 440	900 mA	21.6 W	2,600lx	800lx		■	700 g	MB-NP-480-K

**Machine lighting accessories**  
see "MB-SB-Z Accessories for machine and signal lighting," page 237

## MB-RGBW MACHINE LIGHTING WITH STATUS INDICATOR

This machine lighting from di-soric offers the highest light quality in white and RGB which meets the strictest requirements. Individualized color parameterization is possible by means of IO-Link. Compact construction and load-free triggers are further features of this lighting.



Technical data (typ.)	+20 °C
Service voltage	24 VDC (Supply Class 2)
Operation modes	RGB: constant, blinking, flashing (MB-RGBW...)
Service voltage	24 VDC (Supply Class 2)
Light color	RGB + user-defined
Ambient temperature	0 to 40 °C
Protection type	IP 67
Housing material	Aluminum, natural anodized
Connection cable	VK .../5 (optionally available)

	Illuminated area (mm)	No-load current at 24 V	Power draw at 24 V	IO-Link	Luminous flux		Cable 300 mm, M12, 3-pin	Weight (excluding packaging)	Product description
<b>MB-RGBW</b> with status indicator									
	220 x 30	305 mA	7.3 W	■	440lm		■	210 g	MB-RGBW-251-K-B5
	440 x 30	650 mA	15.6 W	■	1100lm		■	390 g	MB-RGBW-481-K-B5
	660 x 30	1,100 mA	26.4 W	■	2200lm		■	550 g	MB-RGBW-701-K-B5
	870 x 30	1,520 mA	36.5 W	■	3300lm		■	700 g	MB-RGBW-911-K-B5

**Machine lighting accessories**  
see "MB-SB-Z Accessories for machine and signal lighting," page 237



## SB-RGB MULTI-SEGMENT IOL SIGNAL LIGHTING

The SB-RGB are intelligent signal lighting with a large RGB illuminated area. Color, brightness and flashing behavior are freely parameterizable during operation via IO-Link. They can even be used without IO-Link thanks to 8 triggerable color presets.



Technical data (typ.)	+20 °C
Service voltage	18 to 30 VDC (Supply Class 2)
Light color	RGB + user-defined
Ambient temperature	0 to 50 °C
Protection type	IP 67
Operation modes	External trigger, segment & level mode
Operating mode	Static / blinking / flashing
Housing material	Aluminum, natural anodized / PU, glass clear
Plug connector	Cable: 300 mm with M12 connector, 5-pin
Connection cable	VK.../5-SB (available as an option)

	Illuminated area (mm)	Number of segments	No-load current at 24 V DC	Power draw at 24 V	IO-Link	Weight (excluding packaging)	Product description
<b>SB-RGB Multi-Segment IOL signal lighting</b>							
	95 x 30	2	125 mA	3 W	■	115 g	SB-RGB-126-K-B5
	220 x 30	3	210 mA	5 W	■	210 g	SB-RGB-251-K-B5
	440 x 30	6	380 mA	9.1 W	■	390 g	SB-RGB-481-K-B5
	660 x 30	9	560 mA	13.4 W	■	550 g	SB-RGB-701-K-B5
	870 x 30	12	730 mA	17.5 W	■	700 g	SB-RGB-911-K-B5

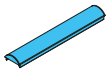
	Accessories for SB-RGB Multi-Segment IOL signal lighting
	see "MB-SB-Z Accessories for machine and signal lighting," page 237

## Signal lights

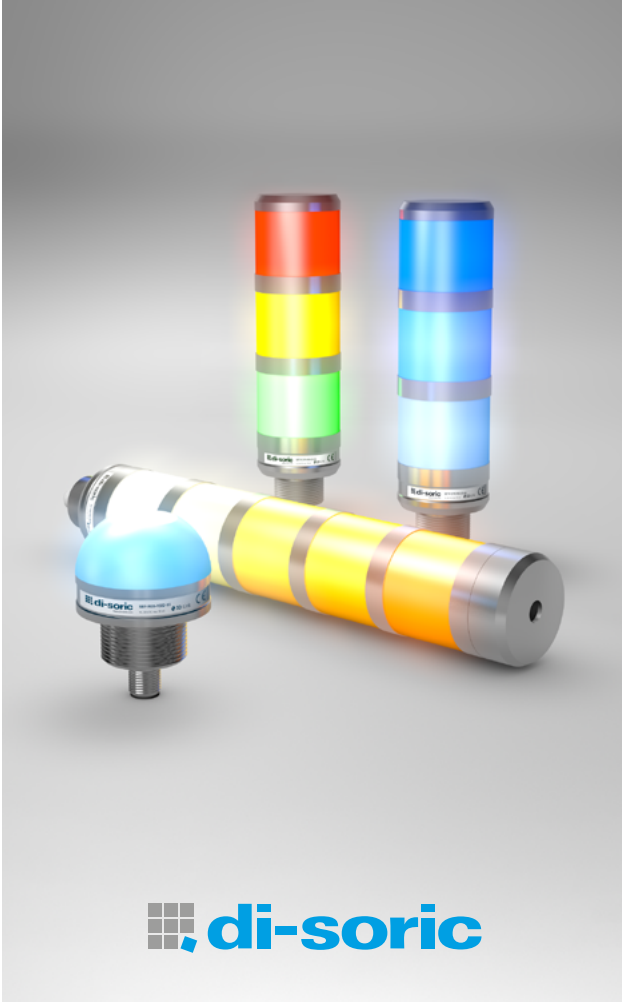
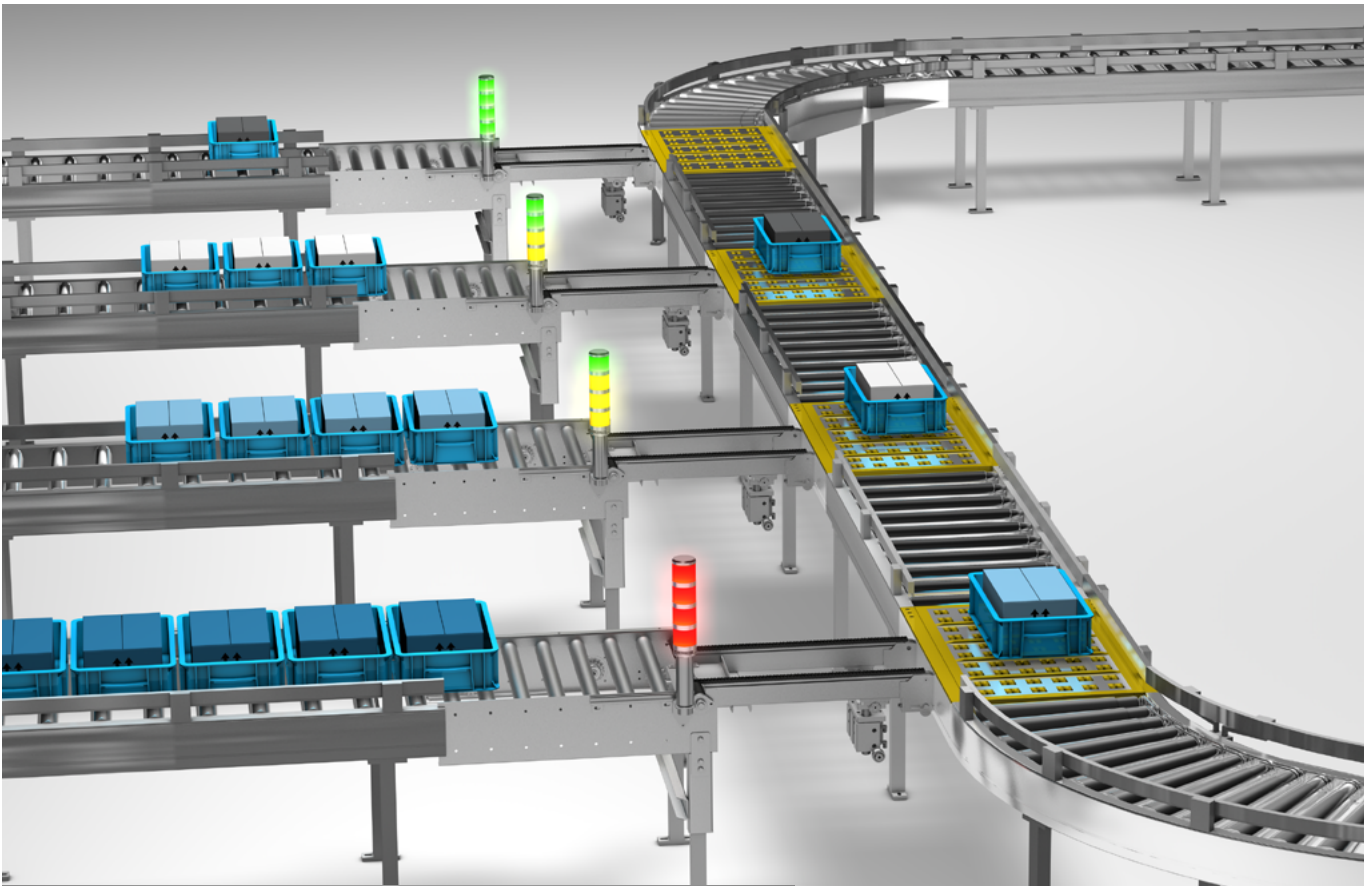

di-soric signal lights with 360° visibility are perfectly suited for industrial status displays. These robust signal lights enable a wide range of color selections and signal display options depending on the task at hand.

SBT-F Multi-Segment Fixed Color Signal Columns	169
SBT-RGB Multi-Segment IOL Signal Columns	170
SBP-RGB 1-Segment IOL signal lights	171

## SBT-F MULTI-SEGMENT FIXED COLOR SIGNAL COLUMNS

The high-efficiency, multi-segment signal column from di-soric offers 360° visibility. With the fixed color coding per segment, the signal column can be used immediately. The compact design and high protection type of the variants without a buzzer enable use in harsh ambient conditions. In combination with a buzzer, the functional scope is substantially expanded.



Technical data (typ.)	+20 °C
Service voltage	24 V DC
Ambient temperature	0 to 50 °C
Housing material	Aluminum, natural anodized / PC, diffuse
Connection	Connector, M12
Connection cable	VK.../5-SB

	Illuminated area (mm)	Segments	Light color/Selection	Buzzer	Intrinsic current consumption at 24 V DC	Power draw at 24 V	Connection	Weight (excluding packaging)	Protection type	Product description
	Ø 50.6x165	3	Red Green Yellow		140 mA	3.4 W	5-pin	270 g	IP 65	SBT-F-GYR-R50-3S-B5
	Ø 50.6x184			■	160 mA	3.8 W	5-pin	310 g	IP 20	SBT-F-GYR-R50-3B-B5
	Ø 50.6x212	4	Red Green Yellow Blue		160 mA	3.8 W	8-pin	310 g	IP 65	SBT-F-BGYR-R50-4S-B8
	Ø 50.6x231			■	180 mA	4.3 W	8-pin	350 g	IP 20	SBT-F-BGYR-R50-4B-B8
	Ø 50.6x259	5	Red Green Yellow Blue White		185 mA	4.4 W	8-pin	350 g	IP 65	SBT-F-WBGYR-R50-5S-B8
	Ø 50.6x278			■	205 mA	4.9 W	8-pin	390 g	IP 20	SBT-F-WBGYR-R50-5B-B8



### Accessories for signal columns

see "SBT-Z Accessories for signal lights," page 237

## SBT-RGB MULTI-SEGMENT IOL SIGNAL COLUMNS

The high-efficiency, multi-segment signal column from di-soric offers 360° visibility. A nearly infinite number of colors, and the individual brightness and the blinking behavior can be parameterized for each segment through IO-Link. The compact design and high protection type of the variants without a buzzer enable use in harsh ambient conditions. The greatest flexibility is made possible in combination with a buzzer.



Technical data (typ.)	+20 °C
Service voltage	18 to 30 VDC (Supply Class 2)
Light color	RGB + user-defined
Ambient temperature	0 to 50 °C
Operation modes	External trigger / segment mode / level mode / demo mode
Operating mode	Static / blinking / flashing
Housing material	Aluminum, natural anodized / PC, diffuse
Connection	Connector, M12, 5-pin
Connection cable	VK.../5-SB

	Illuminated area (mm)	Segments	Buzzer	Intrinsic current consumption at 24 V DC	Power draw at 24 V	Weight (excluding packaging)	Protection type	Product description
	Ø 50.6x165	3		175 mA	4.2 W	270 g	IP 65	SBT-RGB-R50-3S-B5
	Ø 50.6x184		■	195 mA	4.7 W	310 g	IP 20	SBT-RGB-R50-3B-B5
	Ø 50.6x212	4		230 mA	5.5 W	310 g	IP 65	SBT-RGB-R50-4S-B5
	Ø 50.6x231		■	250 mA	6 W	350 g	IP 20	SBT-RGB-R50-4B-B5
	Ø 50.6x259	5		285 mA	6.8 W	350 g	IP 67	SBT-RGB-R50-5S-B5
	Ø 50.6x278		■	305 mA	7.3 W	390 g	IP 20	SBT-RGB-R50-5B-B5

Accessories for signal columns	
	see "SBT-Z Accessories for signal lights," page 237

## SBP-RGB 1-SEGMENT IOL SIGNAL LIGHTS

The high-efficiency, dome-shaped and multifunctional signal lighting from di-soric offers 360° visibility. A nearly infinite number of colors, and the individual brightness, and the flashing behavior can be parameterized through IO-Link. The compact design and high protection type enable use in rough ambient conditions.

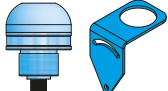

Technical data (typ.)	+20 °C
Service voltage	18 to 30 VDC (Supply Class 2)
Light color	RGB + user-defined
Ambient temperature	0 to 50 °C
Protection type	IP 67
Operation modes	External trigger, segment mode
Operating mode	Static / blinking / flashing
Housing material	Aluminum, natural anodized / PC, diffuse
Connection	Connector, M12, 5-pin
Connection cable	VK.../5-SB

	Illuminated area (mm)	Intrinsic current consumption at 24 V DC	Power draw at 24 V	IO-Link	Weight (excluding packaging)	Maximum overall length of all power supply lines with 5 x 0.34 mm <sup>2</sup> (AWG 22) / min. 24 V DC	Mounting angle	Product description
<b>SBP-RGB 1-Segment IOL signal lights</b>								
	Ø 50x20	75 mA	1.8 W	■	116 g	50 m	■	SBP-RGB-R50D-B5

## Opto-electronic safety sensors

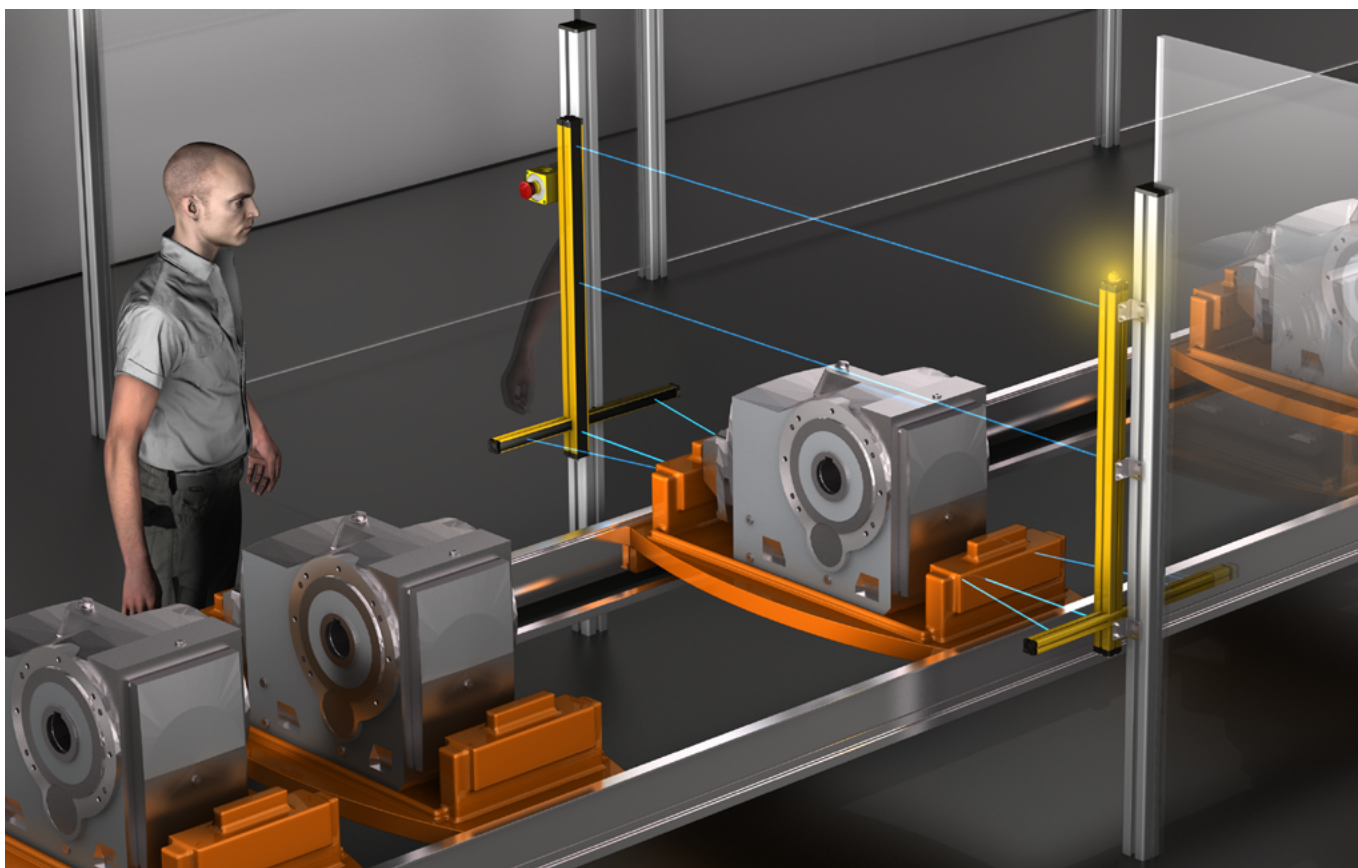

Our opto-electronic safety sensors are used as electro-sensitive protective equipment where danger zones and hazard areas must be reliably and cost-efficiently safeguarded. The large product range also includes robust and resilient variants for technical safety integration up to the highest level of safety.



 **di-soric**

Selection guide for safety light curtains / grids	174
SL-4 Safety light curtains / grids, type 4	176
SL-4M Muting safety light curtains / grids, type 4	184
MA... / MZ Muting arms	185

## PLr risk graph

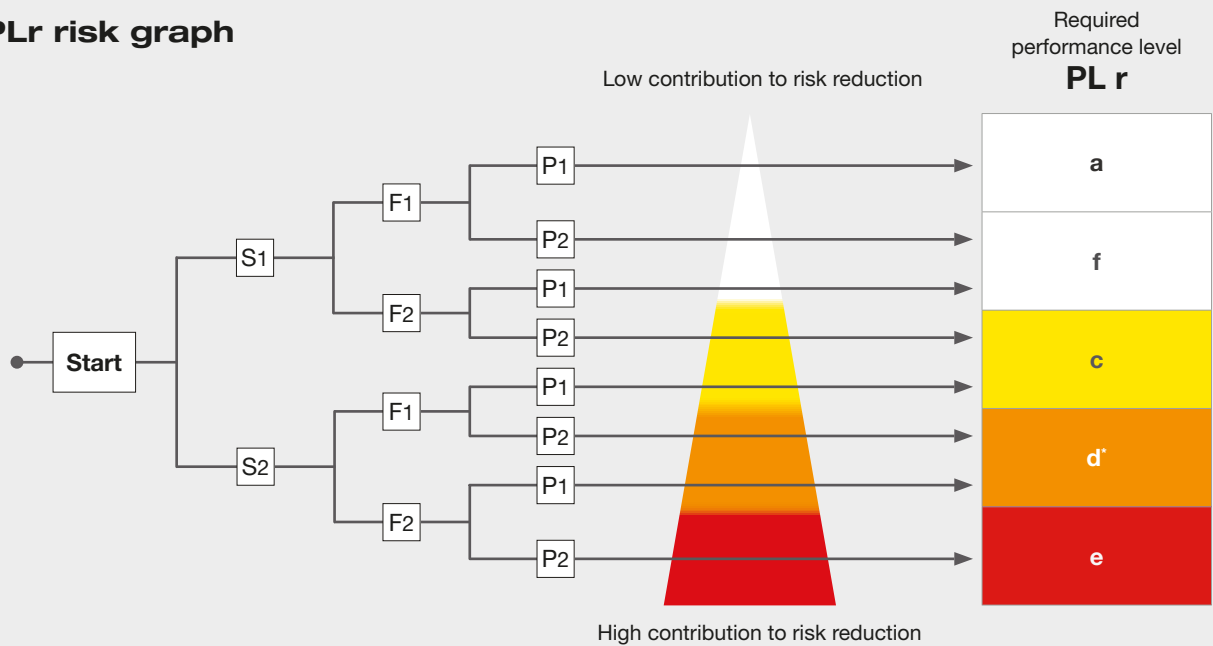

\* If a required performance level PL d is necessary, light barriers with a **Type 4** safety level must be used!

S	Injury severity level
S1	Minor injury (usually reversible)
S2	Serious injury (usually irreversible) or death

F	Frequency and/or duration of the exposure to the hazard
F1	Seldom/short
F2	Continuous/prolonged

P	Possibility of preventing the hazard or limiting the harm
P1	Possible under certain conditions
P2	Virtually impossible

→ **Note:** The PLr values are entirely „hierarchical“. PLr(e) provides the largest and PLr(a) provides the smallest amount for risk reduction.

## Directives and standards for PL e

Safety light curtains / grids

Type 4 / Type 4 in accordance with IEC/TS 61496-2  
 SIL 3 – SILCL 3 in accordance with IEC 61508 - IEC 62061 **PL e – Cat. 4** in accordance with ISO 13849-1

▪ **Corresponds to the following directives and standards:**

- 2006/42/EG „Machinery Directive“
- 2014/30/EU „EMC Directive / Directive relating to electromagnetic compatibility“
- 2014/35/EU „Low Voltage Directive“
- 2011/65/EU „RoHS Directive“
- IEC/EN 61496-1 Edition 2.1, IEC/TS 61496-2 Edition 2 „Electro-sensitive protective equipment“
- EN ISO 13849-1 „Safety of machinery – Safety-related parts of control systems – General principles for design“
- IEC/EN 62061 ed .1 ; am1 „Sof machinery – Functional safety of safety-related electrical, electronic and programmable electronic control systems“
- IEC 61508-1, -2, -3, -4 ed.2 „Functional safety of safety-related electrical, electronic and programmable electronic systems“
- EN 50178: 1997 „Electronic equipment for use in power installations“
- EN 55022: 2010 „Information technology equipment – Radio disturbance characteristics – Limits and methods of measurement“
- EN 61000-6-2: 2005 „Electromagnetic compatibility (EMV) - Part 6-2: Generic standards – Immunity for industrial environments“
- UL (C+US) for Canada and the USA
- ANSI / UL 1998 „Safety software in programmable components“

**Safety level**

**TYPE 4**

SIL 3 – SILCL 3  
PL e – Cat. 4



## SELECTION GUIDE FOR SAFETY LIGHT CURTAINS / GRIDS

It is helpful to divide the application of safety light curtains / grids into four groups:



Detection of a finger



Detection of a body in the danger zone



Detection of a finger





Detection of a body during access control

 Finger protection	SLB4-...	SLI4-...
Light barrier type	Light curtain	
Safety level	<b>Type 4 SIL 3 – SILCL 3 PL e – Cat. 4</b>	
Resolution	14 mm	
Protective field height	160 - 1,810 mm	
Maximum operating distance	6 m	
Start / restart interlock integrated	-	✓
EDM integrated	-	✓
Master/slave versions	-	✓ (Slave / Slave 2)

 Hand protection	SLB4-...	SLBH4-...	SLI4-...	SLIH4-...	SL-4M-...
Light barrier type	Light curtain				Light curtain with muting lamp
Safety level	<b>Type 4 SIL 3 – SILCL 3 PL e – Cat. 4</b>				
Resolution	20 - 30 - 40 mm				30 mm
Protective field height	160 - 1,810 mm				310 - 2,260 mm
Maximum range	12 m	20 m	12 m	20 m	12 m
Start / restart interlock integrated	-	-	✓	✓	✓
EDM integrated	-	-	✓	✓	✓
Master/slave versions	-	-	✓ (Slave / Slave 2)	-	-



 Body protection	SLB4-...	SLBH4-...	SLI4-...	SLIH4-...
Light barrier type	Light curtain			
Safety level	<b>Type 4 SIL 3 – SILCL 3 PL e – Cat. 4</b>			
Resolution	50 - 90 mm			
Protective field height	160 - 1,810 mm			
Maximum operating distance	12 m	20 m	12 m	20 m
Start / restart interlock integrated	-	-	✓	✓
EDM integrated	-	-	✓	✓
Master/slave versions	-	-	✓ (Slave / Slave 2)	-

 Access control	SLB4-xB	SLBH4-xB	SLI4-xB	SLIH4-xB	SL-4M-...
Light barrier type	Light grids				Light grid with muting lamp
Safety level	<b>Type 4 SIL 3 – SILCL 3 PL e – Cat. 4</b>				
Number of beams	2 - 3 - 4				
Beam separation (axis distance)	300 - 400 - 500 mm				
Protective field height	510 - 810 - 910 mm				-
Maximum range	12 m	20 m	12 m	20 m	12 m
Start / restart interlock integrated	-	-	✓	✓	✓
EDM integrated	-	-	✓	✓	✓
Master/slave versions	-	-	✓ (Slave / Slave 2)	-	-

**Glossary**

**Start / restart interlock:**

Locking function when the machine is started or restarted (manual confirmation required).

**EDM- External Device Monitoring:**

Monitoring of the external switch protection devices using a feedback input.

**Master/slave:**

Two or three light curtains/grids can be switched in series; all outputs are managed by only one light curtain/grid (Master).

## SL-4 SAFETY LIGHT CURTAINS / GRIDS, TYPE 4

With safety level type 4, these safety light curtains / grids cover the highest safety level for finger, hand and body protection or in access control. The compact, slim devices can also be installed in confined space conditions. The master/slave variants as well as a version with integrated control function (EDM) are available as options.





Technical data (typ.)	+20°C, 24 VDC
Safety level	<b>Type 4</b> in accordance with IEC/TS 61496-2 <b>SIL 3 – SILCL 3</b> in accordance with IEC 61508 - IEC 62061 <b>PL e – Cat. 4</b> in accordance with ISO 13849-1
Profile cross section	28x30mm
Safety outputs	PNP (2x), 400mA, 24V DC
LED displays	Self-diagnostics Status
Start / restart	Automatic
Service voltage	19.2 to 28.8V DC
Master connection	M12, 5-pin M12, 8-pin (receiver) (SLB... and SLI...)
Length of connection cable	max. 100m unshielded
Ambient temperature	-20 to +55°C
Protection type	IP 65 + IP 67
Protection class	III, operation on protective low voltage
Housing material	Aluminum
Window material	Polycarbonate
Mounting	Rear side, T-groove, or by the use of adjustable brackets SFB E180 (optional)

		Resolution / beam separation	Number of beams	Protective field height (mm)	Total height (mm)	Response time (ms)	Connection cable (optionally available)	Product description			
SL-4 Safety light curtain / grid						SLB4	SLBH4	SLI4	SLIH4		
Special feature						For external safety functions		Integrated safety functions			
Operating distance						up to 6 m		up to 6 m			
	Finger protection 14 mm	15	160	213	4	<b>Transmitter</b> CD ...	SLB4-151		SLI4-151 <sup>1)</sup>		
		30	310	363	5.5		SLB4-301		SLI4-301 <sup>1)</sup>		
		45	460	513	7.5		SLB4-451		SLI4-451 <sup>1)</sup>		
		60	610	663	9		SLB4-601		SLI4-601 <sup>1)</sup>		
		75	760	813	11		SLB4-751		SLI4-751 <sup>1)</sup>		
		90	910	963	13		SLB4-901		SLI4-901 <sup>1)</sup>		
		105	1,060	1,113	14.5		<b>Receiver</b> CD... / SLI... : C8D	SLB4-1051		SLI4-1051 <sup>1)</sup>	
		120	1,210	1,263	16.5			SLB4-1201		SLI4-1201 <sup>1)</sup>	
		135	1,360	1,413	18			SLB4-1351		SLI4-1351 <sup>1)</sup>	
		150	1,510	1,563	20			SLB4-1501		SLI4-1501 <sup>1)</sup>	
		165	1,660	1,713	22			SLB4-1651		SLI4-1651 <sup>1)</sup>	
180	1,810	1,886	23.5	SLB4-1801		SLI4-1801 <sup>1)</sup>					

<sup>1)</sup> see "Note," page 180

						Resolution / beam separation	Number of beams	Protective field height (mm)	Total height (mm)	Response time (ms)	Connection cable (optionally available)	Product description
SL-4 Safety light curtain / grid						SLB4	SLBH4	SLI4	SLIH4			
Special feature						For external safety functions			Integrated safety functions			
Operating distance						up to 12 m		up to 20 m		up to 12 m		up to 20 m
	Hand protection 20mm	15	160	213	4	<b>Transmitter</b> CD...		SLBH4-152		SLIH4-152		
		30	310	363	5.5			SLBH4-302		SLIH4-302		
		45	460	513	7.5			SLBH4-452		SLIH4-452		
		60	610	663	9			SLBH4-602		SLIH4-602		
		75	760	813	11			SLBH4-752		SLIH4-752		
		90	910	963	13		<b>Receiver</b> CD... / C8D		SLBH4-902		SLIH4-902	
		105	1,060	1,113	14.5				SLBH4-1052		SLIH4-1052	
		120	1,210	1,263	16.5				SLBH4-1202		SLIH4-1202	
		135	1,360	1,413	18				SLBH4-1352		SLIH4-1352	
		150	1,510	1,563	20				SLBH4-1502		SLIH4-1502	
		165	1,660	1,713	22				SLBH4-1652		SLIH4-1652	
		180	1,810	1,886	23.5			SLBH4-1802		SLIH4-1802		
Operating distance						up to 12 m		up to 20 m		up to 12 m		up to 20 m
	Hand protection 30mm	8	160	213	4	<b>Transmitter</b> CD...	SLB4-153		SLI4-153 <sup>1)</sup>			
		13	260	313	5		SLB4-253		SLI4-253 <sup>1)</sup>			
		16	310	363	5.4		SLB4-303		SLI4-303 <sup>1)</sup>			
		23	460	513	7.5		SLB4-453		SLI4-453 <sup>1)</sup>			
		31	610	663	9		SLB4-603		SLI4-603 <sup>1)</sup>			
		38	760	813	10.5		SLB4-753		SLI4-753 <sup>1)</sup>			
		46	910	963	12.5		SLB4-903		SLI4-903 <sup>1)</sup>			
		53	1,060	1,113	14		<b>Receiver</b> CD... / C8D	SLB4-1053		SLI4-1053 <sup>1)</sup>		
		61	1,210	1,263	15.5			SLB4-1203		SLI4-1203 <sup>1)</sup>		
		68	1,360	1,413	17			SLB4-1353		SLI4-1353 <sup>1)</sup>		
		76	1,510	1,563	19			SLB4-1503		SLI4-1503 <sup>1)</sup>		
		88	1,660	1,713	20.5			SLB4-1653		SLI4-1653 <sup>1)</sup>		
91	1,810	1,886	22	SLB4-1803		SLI4-1803 <sup>1)</sup>						
Range						up to 12 m		up to 20 m		up to 12 m		up to 20 m
	Hand protection 30mm	8	160	213	3	<b>Transmitter</b> CD...		SLBH4-153		SLIH4-153 <sup>1)</sup>		
		16	310	363	4			SLBH4-303		SLIH4-303 <sup>1)</sup>		
		23	460	513	5			SLBH4-453		SLIH4-453 <sup>1)</sup>		
		31	610	663	6			SLBH4-603		SLIH4-603 <sup>1)</sup>		
		38	760	813	6.5			SLBH4-753		SLIH4-753 <sup>1)</sup>		
		46	910	963	7.5		<b>Receiver</b> CD... / C8D		SLBH4-903		SLIH4-903 <sup>1)</sup>	
		53	1,060	1,113	8.5				SLBH4-1053		SLIH4-1053 <sup>1)</sup>	
		61	1,210	1,263	9.5				SLBH4-1203		SLIH4-1203 <sup>1)</sup>	
		68	1,360	1,413	10				SLBH4-1353		SLIH4-1353 <sup>1)</sup>	
		76	1,510	1,563	11				SLBH4-1503		SLIH4-1503 <sup>1)</sup>	
		88	1,660	1,713	12				SLBH4-1653		SLIH4-1653 <sup>1)</sup>	
		91	1,810	1,886	13			SLBH4-1803		SLIH4-1803 <sup>1)</sup>		



<sup>1)</sup> see "Note," page 180

							Resolution / beam separation	Number of beams	Protective field height (mm)	Total height (mm)	Response time (ms)	Connection cable (optionally available)	Product description	
SL-4 Safety light curtain / grid							SLB4	SLBH4	SLI4	SLIH4				
Special feature							For external safety functions			Integrated safety functions				
Range							up to 12 m	up to 20 m	up to 12 m	up to 20 m				
	Hand protection 40 mm	6	160	213	3.5	<b>Transmitter</b> CD ...	SLB4-154		SLI4-154 <sup>1)</sup>					
		8	260	313	4		SLB4-254		SLI4-254 <sup>1)</sup>					
		11	310	363	4.5		SLB4-304		SLI4-304 <sup>1)</sup>					
		16	460	513	5.5		SLB4-454		SLI4-454 <sup>1)</sup>					
		21	610	663	7		SLB4-604		SLI4-604 <sup>1)</sup>					
		26	760	813	8		SLB4-754		SLI4-754 <sup>1)</sup>					
		31	910	963	9		SLB4-904		SLI4-904 <sup>1)</sup>					
		36	1,060	1,113	10		<b>Receiver</b> CD... / C8D	SLB4-1054		SLI4-1054 <sup>1)</sup>				
		41	1,210	1,263	11			SLB4-1204		SLI4-1204 <sup>1)</sup>				
		46	1,360	1,413	12.5			SLB4-1354		SLI4-1354 <sup>1)</sup>				
		51	1,510	1,563	13.5			SLB4-1504		SLI4-1504 <sup>1)</sup>				
		56	1,660	1,713	14.5			SLB4-1654		SLI4-1654 <sup>1)</sup>				
		61	1,810	1,886	15.5			SLB4-1804		SLI4-1804 <sup>1)</sup>				
Range							up to 12 m	up to 20 m	up to 12 m	up to 20 m				
	Hand protection 40 mm	6	160	213	3	<b>Transmitter</b> CD ...		SLBH4-154		SLIH4-154 <sup>1)</sup>				
		11	310	363	3.5			SLBH4-304		SLIH4-304 <sup>1)</sup>				
		16	460	513	4			SLBH4-454		SLIH4-454 <sup>1)</sup>				
		21	610	663	4.5			SLBH4-604		SLIH4-604 <sup>1)</sup>				
		26	760	813	5			SLBH4-754		SLIH4-754 <sup>1)</sup>				
		31	910	963	6			SLBH4-904		SLIH4-904 <sup>1)</sup>				
		36	1,060	1,113	6.5		<b>Receiver</b> CD... / C8D	SLBH4-1054		SLIH4-1054 <sup>1)</sup>				
		41	1,210	1,263	7			SLBH4-1204		SLIH4-1204 <sup>1)</sup>				
		46	1,360	1,413	7.5			SLBH4-1354		SLIH4-1354 <sup>1)</sup>				
		51	1,510	1,563	8			SLBH4-1504		SLIH4-1504 <sup>1)</sup>				
		56	1,660	1,713	8.5			SLBH4-1654		SLIH4-1654 <sup>1)</sup>				
		61	1,810	1,886	9.5			SLBH4-1804		SLIH4-1804 <sup>1)</sup>				

<sup>1)</sup> see "Note," page 180

						Resolution / beam separation	Number of beams	Protective field height (mm)	Total height (mm)	Response time (ms)	Connection cable (optionally available)	Product description	
SL-4 Safety light curtain / grid						SLB4	SLBH4	SLI4	SLIH4				
Special feature						For external safety functions			Integrated safety functions				
Range						up to 12 m		up to 20 m		up to 12 m		up to 20 m	
	Hand protection 50mm	4	160	213	3	<b>Transmitter</b> CD...	SLB4-155		SLI4-155 <sup>1)</sup>				
		8	310	363	4		SLB4-305		SLI4-305 <sup>1)</sup>				
		12	460	513	4.5		SLB4-455		SLI4-455 <sup>1)</sup>				
		16	610	663	5.5		SLB4-605		SLI4-605 <sup>1)</sup>				
		20	760	813	6.5		SLB4-755		SLI4-755 <sup>1)</sup>				
		24	910	963	7.5		SLB4-905		SLI4-905 <sup>1)</sup>				
		28	1,060	1,113	8.5		<b>Receiver</b> CD... / C8D	SLB4-1055		SLI4-1055 <sup>1)</sup>			
		32	1,210	1,263	9			SLB4-1205		SLI4-1205 <sup>1)</sup>			
		36	1,360	1,413	10			SLB4-1355		SLI4-1355 <sup>1)</sup>			
		40	1,510	1,563	11			SLB4-1505		SLI4-1505 <sup>1)</sup>			
		44	1,660	1,713	12			SLB4-1655		SLI4-1655 <sup>1)</sup>			
48	1,810	1,886	13	SLB4-1805		SLI4-1805 <sup>1)</sup>							
Range						up to 12 m		up to 20 m		up to 12 m		up to 20 m	
	Hand protection 50mm	4	160	213	2.5	<b>Transmitter</b> CD...		SLBH4-155		SLIH4-155 <sup>1)</sup>			
		8	310	363	3			SLBH4-305		SLIH4-305 <sup>1)</sup>			
		12	460	513	3.5			SLBH4-455		SLIH4-455 <sup>1)</sup>			
		16	610	663	4			SLBH4-605		SLIH4-605 <sup>1)</sup>			
		20	760	813	4.5			SLBH4-755		SLIH4-755 <sup>1)</sup>			
		24	910	963	5		<b>Receiver</b> CD... / C8D		SLBH4-905		SLIH4-905 <sup>1)</sup>		
		28	1,060	1,113	5.5			SLBH4-1055		SLIH4-1055 <sup>1)</sup>			
		32	1,210	1,263	6			SLBH4-1205		SLIH4-1205 <sup>1)</sup>			
		36	1,360	1,413	6.5			SLBH4-1355		SLIH4-1355 <sup>1)</sup>			
		40	1,510	1,563	7			SLBH4-1505		SLIH4-1505 <sup>1)</sup>			
		44	1,660	1,713	7		SLBH4-1655		SLIH4-1655 <sup>1)</sup>				
48	1,810	1,886	8	SLBH4-1805		SLIH4-1805 <sup>1)</sup>							
Range						up to 12 m		up to 20 m		up to 12 m		up to 20 m	
	Body protection 90mm	4	310	363	3	<b>Transmitter</b> CD...	SLB4-309		SLI4-309 <sup>1)</sup>				
		6	460	513	3.5		SLB4-459		SLI4-459 <sup>1)</sup>				
		8	610	663	4		SLB4-609		SLI4-609 <sup>1)</sup>				
		10	760	813	4.5		SLB4-759		SLI4-759 <sup>1)</sup>				
		12	910	963	5		SLB4-909		SLI4-909 <sup>1)</sup>				
		14	1,060	1,113	5.5		SLB4-1059		SLI4-1059 <sup>1)</sup>				
		16	1,210	1,263	5.5		<b>Receiver</b> CD... / C8D	SLB4-1209		SLI4-1209 <sup>1)</sup>			
		18	1,360	1,413	6			SLB4-1359		SLI4-1359 <sup>1)</sup>			
		20	1,510	1,563	6.5			SLB4-1509		SLI4-1509 <sup>1)</sup>			
		22	1,660	1,713	7			SLB4-1659		SLI4-1659 <sup>1)</sup>			
		24	1,810	1,886	7.5			SLB4-1809		SLI4-1809 <sup>1)</sup>			

<sup>1)</sup> see "Note," page 180

							Resolution / beam separation	Number of beams	Protective field height (mm)	Total height (mm)	Response time (ms)	Connection cable (optionally available)	Product description
SL-4 Safety light curtain / grid							SLB4	SLBH4	SLI4	SLIH4			
Special feature							For external safety functions			Integrated safety functions			
Range							up to 12 m	up to 20 m	up to 12 m	up to 20 m			
	Body protection 90mm	4	310	363	2.5	<b>Transmitter</b> CD ...		SLBH4-309		SLIH4-309 <sup>1)</sup>			
		6	460	513	3			SLBH4-459		SLIH4-459 <sup>1)</sup>			
		8	610	663	3			SLBH4-609		SLIH4-609 <sup>1)</sup>			
		10	760	813	3.5			SLBH4-759		SLIH4-759 <sup>1)</sup>			
		12	910	963	3.5		<b>Receiver</b> CD... / C8D		SLBH4-909		SLIH4-909 <sup>1)</sup>		
		14	1,060	1,113	3.5				SLBH4-1059		SLIH4-1059 <sup>1)</sup>		
		16	1,210	1,263	4				SLBH4-1209		SLIH4-1209 <sup>1)</sup>		
		18	1,360	1,413	4				SLBH4-1359		SLIH4-1359 <sup>1)</sup>		
		20	1,510	1,563	4.5				SLBH4-1509		SLIH4-1509 <sup>1)</sup>		
		22	1,660	1,713	4.5				SLBH4-1659		SLIH4-1659 <sup>1)</sup>		
24	1,810	1,886	5		SLBH4-1809		SLIH4-1809 <sup>1)</sup>						
Range							up to 12 m	up to 20 m	up to 12 m	up to 20 m			
	500	2	510	653	2.5	<b>Transmitter</b> CD ... <b>Receiver</b> CD... / SLI... : C8D	SLB4-2B		SLI4-2B <sup>1)</sup>				
	400	3	810	953	3		SLB4-3B		SLI4-3B <sup>1)</sup>				
	300	4	910	1,053	3		SLB4-4B		SLI4-4B <sup>1)</sup>				
	500	2	510	653	2.5	<b>Transmitter</b> CD ... <b>Receiver</b> CD... / SLI... : C8D		SLBH4-2B		SLIH4-2B <sup>1)</sup>			
	400	3	810	953	2.5			SLBH4-3B		SLIH4-3B <sup>1)</sup>			
	300	4	910	1,053	2.5			SLBH4-4B		SLIH4-4B <sup>1)</sup>			

<sup>1)</sup> see "Note," page 180

**Note**



<sup>1)</sup>Light curtains / grids are also available as a variant in a protective housing.

SLI... -WTF (IP 69K)

SLI... -WTHF (IP 69K, heated)

**SL-4 Master/slave models with integrated control functions**

Technical data (typ.)	+20 °C, 24 VDC
Safety level	<b>Type 4</b> in accordance with IEC/TS 61496-2 <b>SIL 3 – SILCL 3</b> in accordance with IEC 61508 - IEC 62061 <b>PL e – Cat. 4</b> in accordance with ISO 13849-1
Profile cross section	28x30mm
Safety outputs (master)	PNP (2x), 400 mA, 24V DC
LED displays	Self-diagnostics Status
Start / restart (master)	Automatic or manual (selectable)
External relay (device) monitoring - EDM (master models)	Feedback input, selectable release
Service voltage	19.2 to 28.8V DC
Master connection	M12, 5-pin (transmitter) M12, 8-pin (receiver)
Master / slave 2 / slave connection	M12, 5-pin (transmitter and receiver)
Length of connection cable	max. 100m unshielded
Length of connection cable	max. 50m unshielded (between master/slave)
Ambient temperature	-20to +55 °C
Protection type	IP 65 + IP 67
Protection class	III, operation on protective low voltage
Housing material	Aluminum
Window material	Polycarbonate
Mounting	Rear side, T-groove, or by the use of adjustable brackets SFB E180 (optional)

		Resolution / beam separation	Number of beams (mm)	Protective field height (mm)	Master / slave 2 (mm)	Slave (mm)	Total height	Conf. range				
								Low Range to (m)	High Range to (m)	Product description		
SL-4 Safety light curtain / grid								Master	Slave	Slave 2		
	Finger protection 14mm	15	160	-	213	3	3	6			SLI4-151-S	
		30	310	387	363					SLI4-301-M	SLI4-301-S	SLI4-301-S2
		45	460	537	513					SLI4-451-M	SLI4-451-S	SLI4-451-S2
		60	610	687	663					SLI4-601-M	SLI4-601-S	SLI4-601-S2
		75	760	837	813					SLI4-751-M	SLI4-751-S	SLI4-751-S2
		90	910	987	963					SLI4-901-M	SLI4-901-S	SLI4-901-S2
		105	1,060	1,137	1,113					SLI4-1051-M	SLI4-1051-S	SLI4-1051-S2
		120	1,210	1,287	1,263					SLI4-1201-M	SLI4-1201-S	SLI4-1201-S2
		135	1,360	1,437	1,413					SLI4-1351-M	SLI4-1351-S	SLI4-1351-S2
		150	1,510	1,587	1,563					SLI4-1501-M	SLI4-1501-S	SLI4-1501-S2
		165	1,660	1,737	1,713					SLI4-1651-M	SLI4-1651-S	SLI4-1651-S2
180	1,810	1,910	1,886	SLI4-1801-M	SLI4-1801-S	SLI4-1801-S2						
	Hand protection 30mm	8	160	-	213	4	4	12			SLI4-153-S	
		13	260	337	313					SLI4-253-M	SLI4-253-S	SLI4-253-S2
		16	310	387	363					SLI4-303-M	SLI4-303-S	SLI4-303-S2
		23	460	537	513					SLI4-453-M	SLI4-453-S	SLI4-453-S2
		31	610	687	663					SLI4-603-M	SLI4-603-S	SLI4-603-S2
		38	760	837	813					SLI4-753-M	SLI4-753-S	SLI4-753-S2
		46	910	987	963					SLI4-903-M	SLI4-903-S	SLI4-903-S2
		53	1,060	1,137	1,113					SLI4-1053-M	SLI4-1053-S	SLI4-1053-S2
		61	1,210	1,287	1,263					SLI4-1203-M	SLI4-1203-S	SLI4-1203-S2
		68	1,360	1,437	1,413					SLI4-1353-M	SLI4-1353-S	SLI4-1353-S2
		76	1,510	1,587	1,563					SLI4-1503-M	SLI4-1503-S	SLI4-1503-S2
		88	1,660	1,737	1,713					SLI4-1653-M	SLI4-1653-S	SLI4-1653-S2
		91	1,810	1,910	1,886					SLI4-1803-M	SLI4-1803-S	SLI4-1803-S2

	Resolution / beam separation	Number of beams (mm)	Protective field height (mm)	Total height		Conf. range		Product description			
				Master / slave 2 (mm)	Slave (mm)	Low Range to (m)	High Range to (m)				
SL-4 Safety light curtain / grid								Master	Slave	Slave 2	
	Hand protection 40mm	6	160	-	213	4	12		SLI4-154-S		
		8	260	337	313			SLI4-254-M	SLI4-254-S	SLI4-254-S2	
		11	310	387	363			SLI4-304-M	SLI4-304-S	SLI4-304-S2	
		16	460	537	513			SLI4-454-M	SLI4-454-S	SLI4-454-S2	
		21	610	687	663			SLI4-604-M	SLI4-604-S	SLI4-604-S2	
		26	760	837	813			SLI4-754-M	SLI4-754-S	SLI4-754-S2	
		31	910	987	963			SLI4-904-M	SLI4-904-S	SLI4-904-S2	
		36	1,060	1,137	1,113			SLI4-1054-M	SLI4-1054-S	SLI4-1054-S2	
		41	1,210	1,287	1,263			SLI4-1204-M	SLI4-1204-S	SLI4-1204-S2	
		46	1,360	1,437	1,413			SLI4-1354-M	SLI4-1354-S	SLI4-1354-S2	
		51	1,510	1,587	1,563			SLI4-1504-M	SLI4-1504-S	SLI4-1504-S2	
		56	1,660	1,737	1,713			SLI4-1654-M	SLI4-1654-S	SLI4-1654-S2	
61	1,810	1,910	1,886	SLI4-1804-M	SLI4-1804-S	SLI4-1804-S2					
	Body protection 50mm	4	160	-	213	4	12		SLI4-155-S		
		8	310	387	363			SLI4-305-M	SLI4-305-S	SLI4-305-S2	
		12	460	537	513			SLI4-455-M	SLI4-455-S	SLI4-455-S2	
		16	610	687	663			SLI4-605-M	SLI4-605-S	SLI4-605-S2	
		20	760	837	813			SLI4-755-M	SLI4-755-S	SLI4-755-S2	
		24	910	987	963			SLI4-905-M	SLI4-905-S	SLI4-905-S2	
		28	1,060	1,137	1,113			SLI4-1055-M	SLI4-1055-S	SLI4-1055-S2	
		32	1,210	1,287	1,263			SLI4-1205-M	SLI4-1205-S	SLI4-1205-S2	
		36	1,360	1,437	1,413			SLI4-1355-M	SLI4-1355-S	SLI4-1355-S2	
		40	1,510	1,587	1,563			SLI4-1505-M	SLI4-1505-S	SLI4-1505-S2	
		44	1,660	1,737	1,713			SLI4-1655-M	SLI4-1655-S	SLI4-1655-S2	
		48	1,810	1,910	1,886			SLI4-1805-M	SLI4-1805-S	SLI4-1805-S2	
	Body protection 90mm	4	310	387	363	4	12	SLI4-309-M	SLI4-309-S	SLI4-309-S2	
		6	460	537	513			SLI4-459-M	SLI4-459-S	SLI4-459-S2	
		8	610	687	663			SLI4-609-M	SLI4-609-S	SLI4-609-S2	
		10	760	837	813			SLI4-759-M	SLI4-759-S	SLI4-759-S2	
		12	910	987	963			SLI4-909-M	SLI4-909-S	SLI4-909-S2	
		14	1,060	1,137	1,113			SLI4-1059-M	SLI4-1059-S	SLI4-1059-S2	
		16	1,210	1,287	1,263			SLI4-1209-M	SLI4-1209-S	SLI4-1209-S2	
		18	1,360	1,437	1,413			SLI4-1359-M	SLI4-1359-S	SLI4-1359-S2	
		20	1,510	1,587	1,563			SLI4-1509-M	SLI4-1509-S	SLI4-1509-S2	
		22	1,660	1,737	1,713			SLI4-1659-M	SLI4-1659-S	SLI4-1659-S2	
		24	1,810	1,910	1,886			SLI4-1809-M	SLI4-1809-S	SLI4-1809-S2	
			Beams 2-3-4	500	2			510	677	653	4
400	3			810	977	953	SLI4-3B-M	SLI4-3B-S	SLI4-3B-S2		
300	4			910	1,077	1,053	SLI4-4B-M	SLI4-4B-S	SLI4-4B-S2		



## Function of master/slave models

The master/slave model makes it possible to switch up to three light curtains/grids in series and to have combined detection of hands and body, or to simultaneously monitor various sides of the machine. With the following critical advantages:

- Only one pair of safety outputs
- No interference between light barriers installed in adjacent spaces

### Examples for series connection of master/slave models

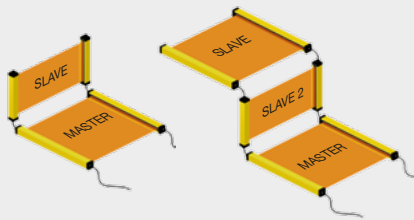

It is possible to connect each master model to any slave model. All electrical connections are designed with 5-pin M12 connectors, with the exception of the master receiver, which requires an 8-pin M12 connector.

For the connection between master and slave, cables prefabricated with 2 connectors are available see "SL-Z-E Electrical," page 246.

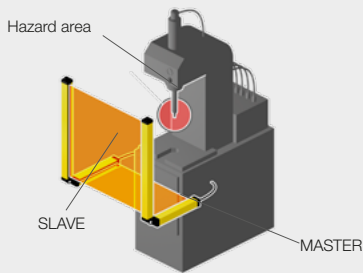

The master is positioned horizontally for detecting a body, while the vertical slave takes over detecting hands.

You can also turn the connection and position the master vertically for protecting hands and the slave horizontally for detecting a body.

The application pictured here is among the most common:

Horizontal safety light curtains / grids are used for preventing the operator from going undetected if he or she remains between the vertical light curtain/grid and the dangerous machine when turning it on or restarting it.

### Example of series connection of master/slave models for protecting two sides of a machine

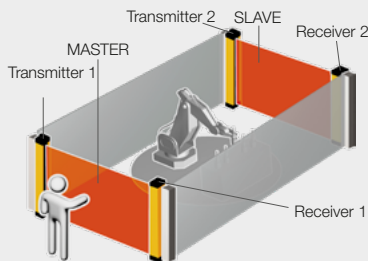

In the case of SLI safety light curtains / grids, a (non-shielded) standard cable is used for the connection between master and slave. It can have a length of up to 50 meters see "SL-Z-E Electrical," page 246.

This property allows for the use of 2 light curtains / grids switched in series, whereby one of them is positioned on the front side and the other on the rear side of the machine; in the event of only one connection for the power supply and the control circuit of the machine.

Up to 3 safety light curtains / grids switched in series are possible.

### Advantage when using master/slave series connections

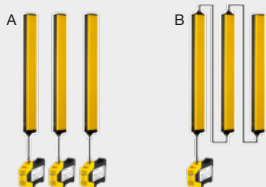

**A** schematic of the series connection:

For three standard light curtains/grids, 3 safety modules or 6 relays have to be used and cabled.

**B** For the master/slave solution with 3 light curtains / grids switched in series,

it is possible to use and cable only 1 safety module or 2 relays.

### Formulas for calculating the total response time in the case of master/slave series connections SLI4-....:

For a resolution of 14 mm	Master + Slave	$t_{tot} = [0.06 \times (\text{No.}_{\text{Master}} + \text{No.}_{\text{Slave}}) + 0.9636] \times 2$
	Master + Slave 2 + Slave	$t_{tot} = [0.06 \times (\text{No.}_{\text{Master}} + \text{No.}_{\text{Slave 2}} + \text{No.}_{\text{Slave}}) + 1.0036] \times 2$
For all other resolutions or beam separations	Master + Slave	$t_{tot} = [0.11 \times (\text{No.}_{\text{Master}} + \text{No.}_{\text{Slave}}) + 0.9376] \times 2$
	Master + Slave 2 + Slave	$t_{tot} = [0.11 \times (\text{No.}_{\text{Master}} + \text{No.}_{\text{Slave 2}} + \text{No.}_{\text{Slave}}) + 1.0508] \times 2$

Key  $t_{tot}$  = Total response time      No. = Number of beams for the selected model

## SL-4M MUTING SAFETY LIGHT CURTAINS / GRIDS, TYPE 4

Type4 Muting SL-4M safety light curtains / grids meet the requirements for the highest safety level Type 4 and permanent personal protection is ensured with unhindered material feed. Additional external muting sensors can be connected to devices with integrated muting function. Ready-to-install muting arms can be added to the modular system.



Technical data (typ.)	+20 °C, 24 VDC
Safety level	<b>Type 4</b> in accordance with TS 61496-2 <b>SIL 3 – SILCL 3</b> in accordance with IEC 61508 - IEC 62061 <b>PL e – Cat. 4</b> in accordance with ISO 13849-1
Profile cross section	50x55mm
Safety outputs	PNP (2x), 400mA, 24V DC
LED displays	Self-diagnostics Status
Start / restart	Automatic or manual (selectable)
External device (relay) monitoring - EDM	Feedback input, selectable release
Service voltage	19.2 to 28.8V DC
Connection (transmitter)	M12, 5-pin (main plug) M12, 5-pin (2x, muting sensors)
Connection (receiver)	M12, 12-pin (main plug) M12, 5-pin (2x, muting sensors) M12, 5-pin (muting light SLM4, SLM4O) configuration M12, 5-pin (configuration SLM4PO)
Length of connection cable	max. 100m unshielded
Ambient temperature	-30 to +55 °C
Degree of protection	IP 65 + IP 67
Protection class	III, operation on protective low voltage
Housing material	Aluminum
Window material	Polycarbonate
Mounting	T-groove (mounting bracket in scope of delivery)

SL-4M Muting safety light curtains / grids, type 4								SLM4O	SLM4PO
Resolution / beam separation (mm)	Number of beams	Beam separation (mm)	Protective field height (mm)	Total height (mm)	Response time (ms)	Connection cable (optionally available)	Product description	Special feature	
Range								Muting (with muting light)	Muting
up to 12 m									
	Detection of a body during access control	2	500	710	5.5	Receiver (main plug) CS12D... (Muting lamp) CD... (Configuration) CS12USB	SLM4O-2B		
		3	400	1,010	5.5		SLM4O-3B	SLM4PO-3B	
		4	300	1,110	5.5		SLM4O-4B	SLM4PO-4B	
	Hand protection 30mm	23	460	570	9.5	Receiver (main plug) CS12D... (Configuration) CS12USB		SLM4PO-453	
		31	610	720	11.0			SLM4PO-603	
		68	1,360	1,470	19.0			SLM4PO-1353	
		76	1,510	1,620	20.5			SLM4PO-1503	
		83	1,660	1,770	22.0			SLM4PO-1653	
		91	1,810	1,920	23.5			SLM4PO-1803	

## MA... / MZ MUTING ARMS

The muting arms MA .../MZ can be directly mounted on and connected to the safety light grids/curtains SL-4M. Multiple muting functions can be implemented thanks to simple hardwire wiring. Even perforated objects, such as pallets, can be detected with the MZ multibeam light barriers.



Technical data (typ.)	+20 °C, 24 VDC
Emitted light	Infrared
Service voltage	19.2 to 28.8 V DC
Switching output	pnp, 100 mA, NO
Ambient temperature	-30to+55 °C

	Muting arm design	Number of muting sensors in set	Parallel (P) or Cross-muting (X)	Range (m)	Operating principle						Adjustment			Product description
					Through-beam sensor	Retroreflective sensor	Through-beam sensor: 5-beam <sup>1)</sup>	Transparent detection, Reduced sensitivity	For high speed belts, with longer muting arms	Safety functions Muting activation	Height adjustable	Rotary position adjustable	IP light	
<b>MA... / MZ Muting arms</b>														
	L	2	X	1 to 2.5	■						■	■	■	MA-L2X
	L	2	P	0 to 3.5		■					■	■	■	MA-L2P TRX
	T	2	X	1 to 2.5	■						■	■	■	MA-T2X
	T	4	P	0 to 3.5		■					■	■	■	MA-T4P TRX
	L	2	X / P	0 to 3.5			■				■	■	■	MZ-L2XP
	T	2	X	0 to 3.5			■				■	■	■	MZ-T2X
	T	4	P	0 to 3.5			■				■	■	■	MZ-T4P

	Housing design Size (mm)	Beam separation (mm)	Number of beams	Operating voltage (VDC)	Response time (ms)	Switching output	Protection type	Ambient temperature (°C)	Cable length, plug connector	Product description
	70 x 28 x 30	10	5	24±20%	100	PNP, 100 mA,	IP 65	-30 to 55	0,9m M12, 5-pin	M5-A
	70 x 28 x 30	10	5	24±20%	100	PNP, 100 mA,	IP 65	-30 to 55	0,9m M12, 5-pin	M5-B

<sup>1)</sup> For pallet machines that work with irregular loads and pallets

**L2X** Muting arms with two crossed muting sensors, material transport out of the danger zone

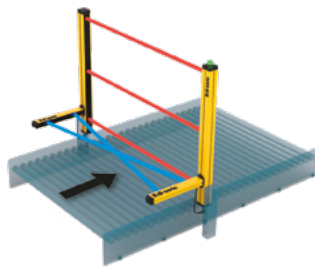
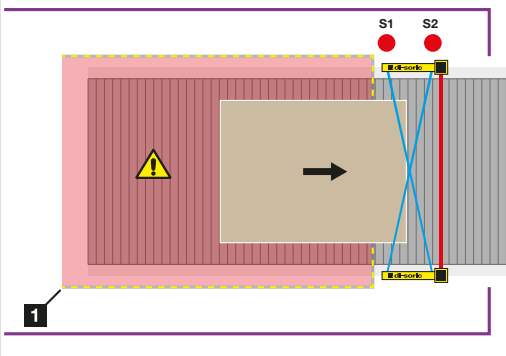

In this muting mode, the two muting arms are located in front of the vertically mounted safety light barrier, facing the danger zone, and are in front of the hazardous passageway.

This unidirectional mode is used for transporting material out of the danger zone

1 = Danger zone

**L2P** with two crossed muting sensors, material transport out of the danger zone

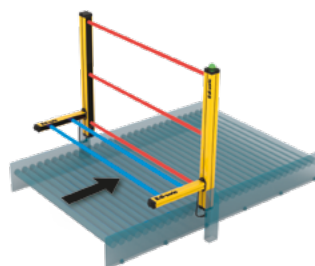
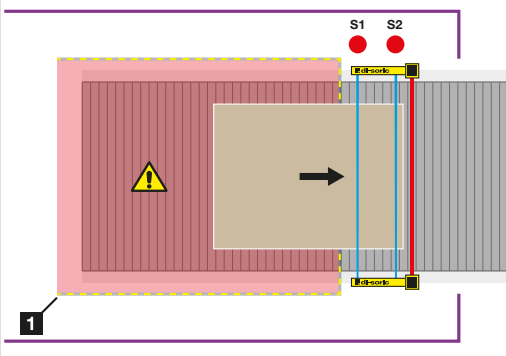

In this muting mode, sensors 1 and 2 are on the same side of the vertical safety light barrier and are in front of the hazardous passageway.

This unidirectional mode is used for protecting material outputs.

1 = Danger zone

**T2X** with two crossed muting sensors, material transport into and out of the danger zone

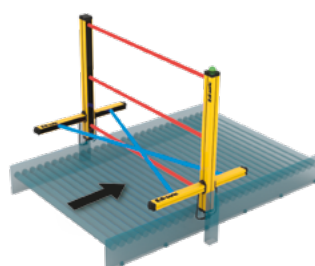
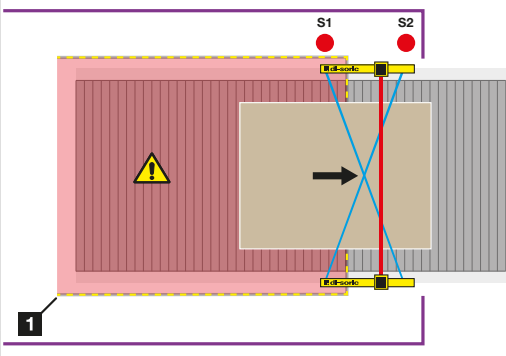

In this muting mode, one sensor (S1) is located on the side of the vertically oriented safety light barrier facing the danger zone. The second sensor (S2) is located on the side facing away from the danger zone.

This bidirectional mode is used for transporting material out of and into the danger zone.

1 = Danger zone

**T4P** with four parallel muting sensors, material transport into and out of the danger zone

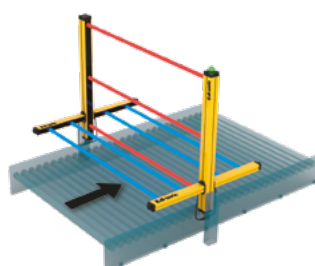
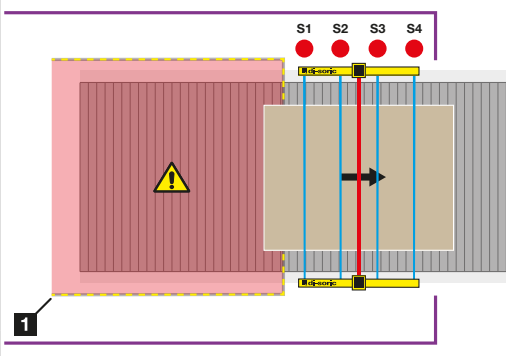

In this muting mode, two sensors are located on one side of the vertical safety light barrier and two are located on the other side.

This bidirectional mode is used for transporting material out of and into the danger zone.

1 = Danger zone



## Reliable control components

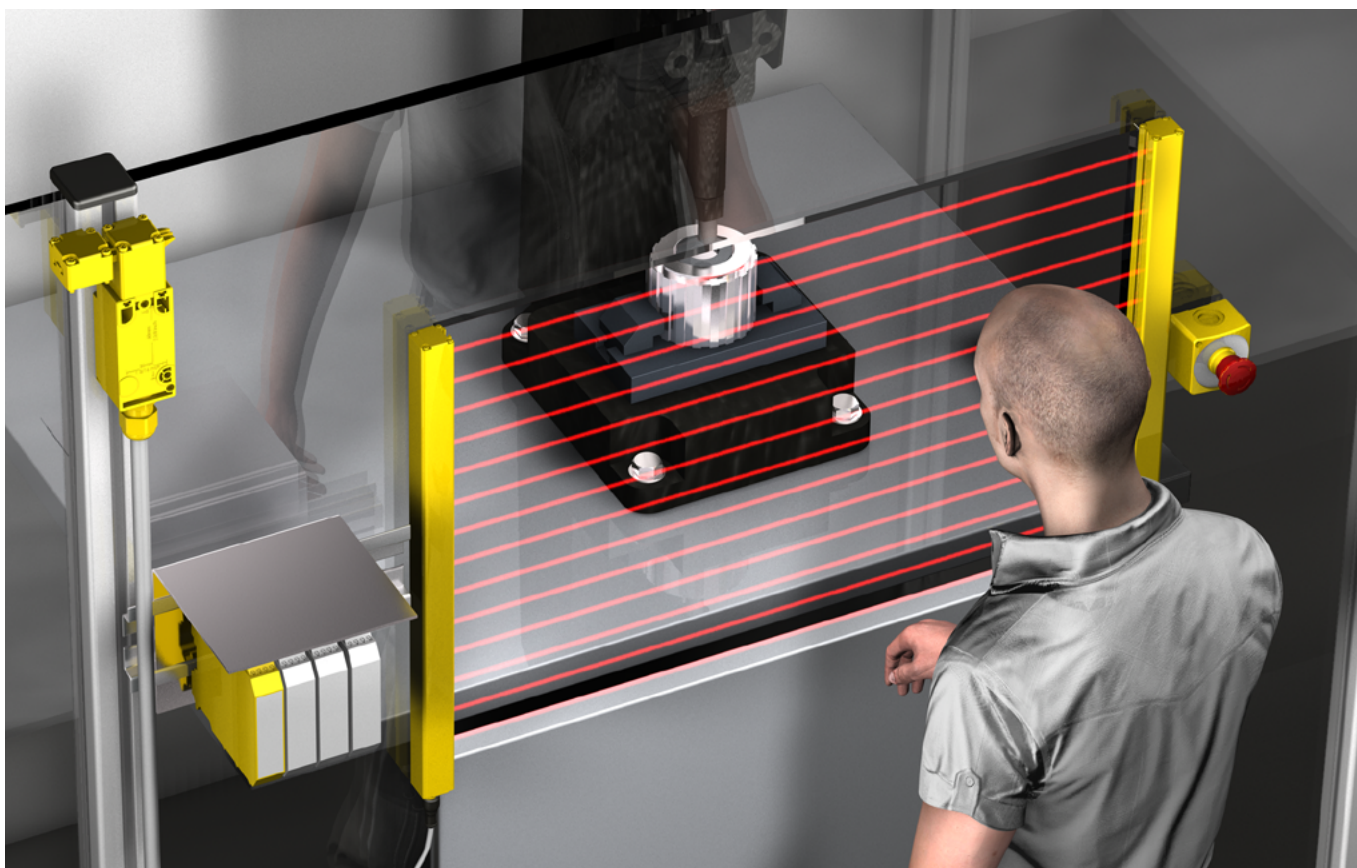

di-soric features various secure control components in its product range with which safety sensors can be integrated into work safety solutions. The result is ideal protection with a high degree of machine availability.



 **di-soric**

SR safety relay / switching devices

190

MODSI Safety control system

191

## PLr risk graph

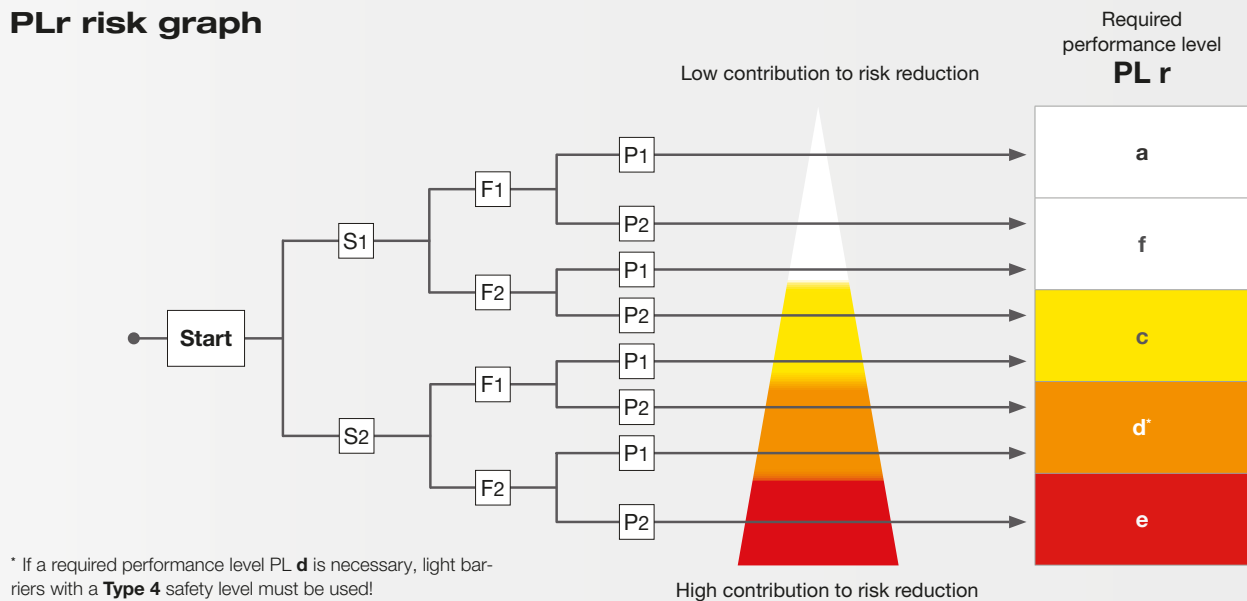

\* If a required performance level PL **d** is necessary, light barriers with a **Type 4** safety level must be used!

S	Injury severity level
S1	Minor injury (usually reversible)
S2	Serious injury (usually irreversible) or death
F	Frequency and/or duration of the exposure to the hazard
F1	Seldom/short
F2	Continuous/prolonged
P	Possibility of preventing the hazard or limiting the harm
P1	Possible under certain conditions
P2	Virtually impossible

→ **Note:** The PLr values are entirely „hierarchical“. PLr(e) provides the largest and PLr(a) provides the smallest amount for risk reduction.

## Directives and standards for PL e

### MODSI- Modular safety system

**Type 4 / Type 4** in accordance with IEC/TS 61496-2

**SIL 3 – SILCL 3** in accordance with IEC 61508 - IEC 62061

**PL e – Cat. 4** in accordance with ISO 13849-1

#### Corresponds to the following directives and standards:

- 2006/42/EG "Machinery Directive"
- 2014/30/EU "EMC Directive / Directive relating to electromagnetic compatibility"
- 2014/35/EU "Low Voltage Directive"
- CEI EN 61131-2 "Programmable controllers, Part 2: Equipment requirements and tests"
- EN ISO 13849-1 "Safety of machinery - Safety-related parts of control systems - General principles for design"
- EN ISO 13849-2 "Safety of machinery: Safety-related parts of control systems - Part 2: Validation"
- IEC/EN 61496-1 "Safety of machinery: Electro-sensitive protective equipment - Part 1: General requirements and tests"
- IEC/EN 62061 "Safety of machinery – Functional safety of safety-related electrical, electronic and programmable electronic control systems"
- IEC 61508-1 "Functional safety of safety-related electrical, electronic and programmable electronic control systems - Part 1: General requirements"
- IEC 61508-2 "Functional safety of safety-related electrical, electronic and programmable electronic control systems - Part 2: Requirements for electrical/electronic/programmable electronic safety-related systems"
- IEC 61508-3 "Functional safety of safety-related electrical, electronic and programmable electronic control systems - Part 3: Software requirements"
- IEC 61508-4 "Functional safety of electrical/electronic/programmable electronic safety-related systems - Part 4: Definitions and abbreviations"
- IEC 61784-3 "Industrial communication networks - Profiles - Part 3: Functional safety fieldbuses– General rules and profile definitions"
- UL (C+US) for Canada and the USA
- ANSI / UL 1998 „Safety software in programmable components“

Safety level

**TYPE 4**





**SIL 3 – SILCL 3**  
**PL e – Cat. 4**





## SR SAFETY RELAY / SWITCHING DEVICES

The safety relay / safety switching devices from di-soric make simple integration of individual safety sensors into occupational safety solutions possible. di-soric can optionally also deliver devices with integrated control function (External Device Monitoring - EDM) or with integrated muting function, to which additional external muting sensors can be connected.

Technical data (typ.)	+20 °C, 24 VDC
Reaction time	< 20 ms
Service voltage	19.2 to 28.8 V DC
Connection	to terminal strip
Ambient temperature	0 to +55 °C
Protection type	IP20 for housing IP2X for terminal strip
Mounting	on top-hat rail in accordance with EN 50022-35 standard

	Dimensions (mm)	Integrated muting function	Start / restart <sup>1)</sup> (Automatic or manual (selectable on terminal strip), interlock)	External device (relay) monitoring - EDM (Feedback input, selectable release)	Two-channel inputs for safety light curtains / grids	Outputs safety relay (2A, 250VAC)	Status output (PNP (1x), 100 mA, 24V DC)	Inputs for muting sensors 2x, 24VDC, PNP, dark-on, NO	Input for muting release 24VDC, PNP or relay	Product description
<b>Safety relay for safety light curtains / grids type 2 and type 4</b>										
	99 x 22.5 x 114.5	■	■	1	NO (2x)	■				SR-1
	99 x 35 x 114.5	■	■	■	1	NO (2x)	■	■	■	SR-M
<sup>1)</sup> Reliable control of the Start / Restart command in accordance with the IEC 61496-1 standard <div style="float: right;">   </div>										

<b>Interface relay for safety light curtains / grids SLI...</b>										
	101 x 35 x 120					NO (2x) NC (1x) <sup>2)</sup>				SR-0
<sup>2)</sup> Each NO safety switching output is interrupted twice by the two relays <div style="float: right;">  </div>										



## MODSI SAFETY CONTROL SYSTEM

The modular and configurable MODSI safety system can monitor and control various safety equipment in parallel, including safety light curtains / grids, mechanical switches, floor mats, emergency stop switches and two-hand circuits, as well as combinations of these. Using expansion modules, MODSI can be individually adapted to the respective safety requirements.

Technical data (typ.)	+20 °C, 24 VDC
Safety level	<b>TYPE 4</b> in accordance with IEC/TS 61496-1, -2 <b>SIL 3 – SILCL 3</b> in accordance with IEC 61508 - IEC 62061 <b>PL e – Cat. 4</b> in accordance with ISO 13849-1
Service voltage	19.2 to 28.8V DC
Connections	Removable terminal strips, screw contacts
Ambient temperature	-10 to +55 °C
Storage temperature	-10 to +85 °C
Protection type	IP20 for housing, IP2X for terminal strip
Mounting	on top-hat rail in accordance with EN 50022-35 standard
Dimensions - HxLxD	99 x 22.5 x 114.5 mm



### MODSI



Compact design









MS-M  
Configuration Memory



MS-SC  
Safety Communication

- Compact design: Design size of each individual module 22.5x99x 114.5 mm
- Removable terminal strips, screw contacts
- Can be used with the most common safety sensors
- Data transmission possible over fieldbus systems
- MS-SD - Safety Designer
  - Simple and intuitive software with a graphical user interface
- A large selection of safety functions and logical operators that can be configured using the software
- MS-M - Configuration Memory
  - Removable memory card for backing up and transferring configuration data
- MS-SC - Safety Communication
  - Communication between the modules over a 5-way high-speed bus
- Max. 14 expansion modules in addition to the M1 master
- Max.128 inputs and 16 OSSD safety outputs (pairs)
- Remote maintenance/control of the MS expansion modules is possible over the MS-SC bus (a range of up to 100 m)
- Digital safety inputs that can be programmed individually or in pairs with the option for monitoring using dedicated output signals
- Filters and delays can be programmed separately for each input
- Delays can be programmed for output activation and deactivation
- Independent control of output pairs possible
- Programmable diagnostic output signals
- Easy diagnostics using LED displays on the front side and the bus expansion modules as well as configuration software MS-SD

	USB connection	MS-M card slot	Connection to MS-SC bus	MS-SC connector including Safety inputs	PNP safety outputs, 400mA OSSD (number of pairs)	PNP signal outputs, 100mA (programmable)	Test outputs	Safety relay outputs: NO (2x) NC (1x) 6A 250 V AC	NO (4x) NC (2x) 6A 250 V AC	Inputs for start / restart (EDM)	LED display	Product description	
<b>Main module MS-1 for the modular safety system MODSI</b>													
	■	■	■	-	8	2	2	4	-	-	2	Status input/output interference diagnosis	MS-1
<b>Expansion module MS-... for the modular safety system MODSI</b>													
	-	-	■	■	8	2	2	4	-	-	2	Status input/output interference diagnosis	MS-18-02
	-	-	■	■	8	-	-	4	-	-	-		MS-18
	-	-	■	■	16	-	-	4	-	-	-		MS-116
	-	-	■	■	12	-	-	8	-	-	-		MS-112-T8
	-	-	■	■	-	2	2	-	-	-	2		MS-02
	-	-	■	■	-	4	4	-	-	-	4		MS-04
	-	-	-	-	-	-	-	-	■	-	1	Output status	MS-R2
	-	-	-	-	-	-	-	-	■	-	2		MS-R4
	-	-	■	■	-	-	-	-	-	■	4		MS-OR4
	-	-	■	■	-	-	8	-	-	■	4		MS-OR4-S8
<b>Expansion modules MS-Vx ... for safety speed monitoring</b>													
	-	-	■	■	1 - 4	Inputs: 2 for PNP/NPN inductive proximity switches					Status input Interference diagnosis	MS-V0	
	-	-	■	■		Inputs: 1 TTL incremental encoder + 1- 2 induct. PNP/NPN proximity switch						MS-V1T	
	-	-	■	■		Inputs: 1 HTL incremental encoder + 1- 2 induct. PNP/NPN proximity switch						MS-V1H	
	-	-	■	■		Inputs: 1 sin/cos incremental encoder + 1- 2 induct. PNP/NPN proximity switch						MS-V1S	
	-	-	■	■		Inputs: 1- 2 TTL incremental encoder + 1- 2 induct. PNP/NPN proximity switch						MS-V2T	
	-	-	■	■		Inputs: 1- 2 HTL incremental encoder + 1- 2 induct. PNP/NPN proximity switch						MS-V2H	
	-	-	■	■		Inputs: 1- 2 sin/cos incremental encoder + 1- 2 induct. PNP/NPN proximity switch						MS-V2S	
	<b>Expansion modules MS-Bx... for bus diagnosis and data transmission</b>												
	■	-	■	■	Profibus DP - expansion module							Error diagnostics	MS-BP
	■	-	■	■	DeviceNET - expansion module								MS-BD
	■	-	■	■	CANopen - expansion module								MS-BC
	■	-	■	■	Ethernet IP - expansion module								MS-BEI
	■	-	■	■	EtherCAT - expansion module								MS-BEC
	■	-	■	■	PROFINET - expansion module								MS-BEP
	■	-	■	■	Universal Serial Bus - expansion module								MS-BU
<b>Interface modules MS-CTx for connecting exported expansion modules via the MS-SC Bus</b>													
	-	-	■	■	Interface with 1 connection * (1 input or 1 output)							Output status	MS-CT1
	-	-	■	■	Interface with 2 connections (1 input and 1 output)								MS-CT2
<b>Configuration memory for main module</b>													
												MS-M	
<b>Safety communication for main/expansion module</b>													
												MS-SC	

\* End or start of the network

**Connection variant with MS-CTx**

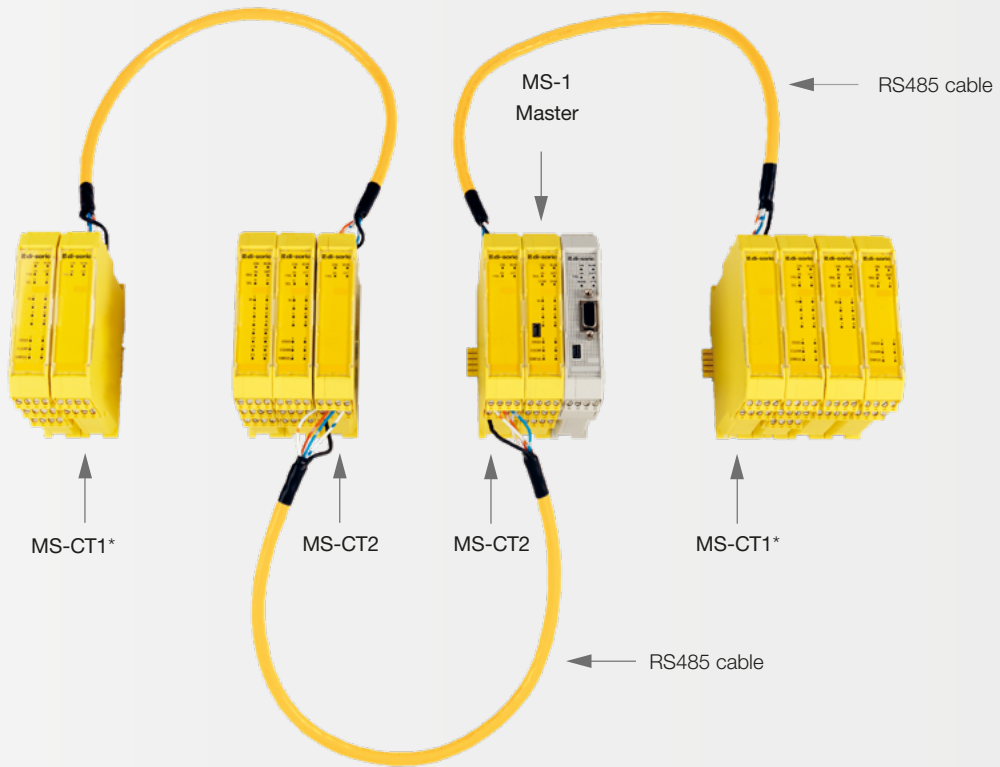

**Connection variant with MS-Vx**

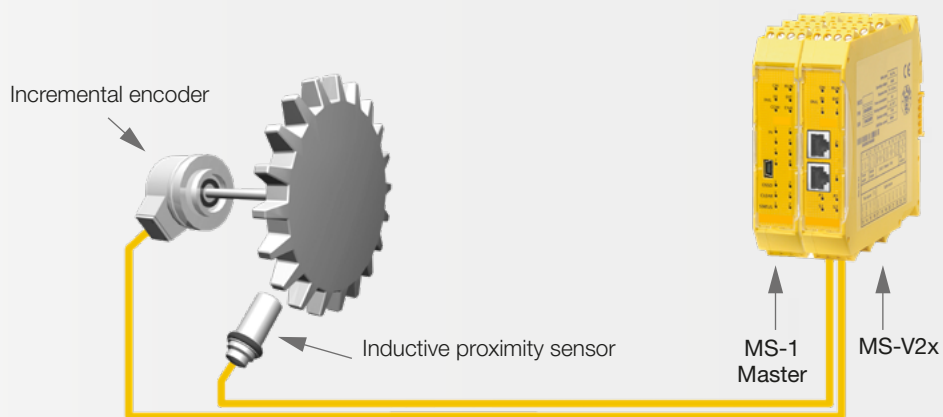

## Connection technology



di-soric offers a comprehensive connection technology range for transmitting signals, data, and power reliably. This includes connection and connecting cables, adapter plugs, and field-attachable plug connectors. In terms of connection technology, a wide variety of cable types, line lengths, pin assignments, and plug connectors are available for customized industrial installations.

Z-AT-ALE Connection cables	195
Z-AT-VLE Connecting cables	197
Z-AT-AST Adapter plugs	198
Z-AT-SVK Field-attachable plug connectors	199





## Z-AT-ALE CONNECTION CABLES

Our open-ended connection cables are the optimal solution for putting all sensors, lighting as well as Vision and ID products into operation. They feature a stable metal union nut, good insulation properties and a high protection type.

Technical data (typ.)	+20 °C, 24 VDC
Protection type	IP 67





	Size	Quantity of wires	Cable length (m)	Metal coupling ring	Max. permissible service voltage (V AC/DC)	To be used for	Connector material	Cable material PVC, PU coating	Cable material PUR	Product description	Connector material	Cable material PVC	Product description
<b>Connection cable M8</b>													
 straight	M8	3	2.5	■	60		Poly-urethane	■		TKHM-Z-2.5 <sup>2)</sup>	PVC	■	TKPM-Z-2.5
			5.0							TKHM-Z-5 <sup>2)</sup>			TKPM-Z-5
			10							TKHM-Z-10			TKPM-Z-10
		2.5	TKHM-Z-2.5/4 <sup>2)</sup>							TKPM-Z-2.5/4			
		5.0	TKHM-Z-5/4 <sup>2)</sup>							TKPM-Z-5/4			
		10	TKHM-Z-10/4							TKPM-Z-10/4			
 angled	M8	3	2.5	■	60		Poly-urethane	■		TKHM-W-2.5 <sup>2)</sup>	PVC	■	TKPM-W-2.5
			5.0							TKHM-W-5 <sup>2)</sup>			TKPM-W-5
			10							TKHM-W-10			TKPM-W-10
		2.5	TKHM-W-2.5/4 <sup>2)</sup>							TKPM-W-2.5/4			
		5.0	TKHM-W-5/4 <sup>2)</sup>							TKPM-W-5/4			
		10	TKHM-W-10/4							TKPM-W-10/4			
<b>Connection cable M12</b>													
 straight	M12	4	2.5	■	250		Poly-urethane	■		VKHM-Z-2.5/4 <sup>2)</sup>	PVC	■	VKPM-Z-2.5/4
			5.0							VKHM-Z-5/4 <sup>2)</sup>			VKPM-Z-5/4
			10.0							VKHM-Z-10/4 <sup>2)</sup>			VKPM-Z-10/4
 straight	M12	5	5.0	■	125	SB-RGB SBP-RGB MB-RGB	Poly-urethane	■		VKHM-Z-5/5 <sup>2)</sup>			
			10.0							VKHM-Z-10/5 <sup>2)</sup>			
			2.5							VKHM-Z-2.5/5-SB			
			5.0							VKHM-Z-5/5-SB			
10.0	VKHM-Z-10/5-SB												
 angled	M12	4	2.5	■	250		Poly-urethane	■		VKHM-W-2.5/4 <sup>2)</sup>	PVC	■	VKPM-W-2.5/4
			5.0							VKHM-W-5/4 <sup>2)</sup>			VKPM-W-5/4
			10.0							VKHM-W-10/4 <sup>2)</sup>			VKPM-W-10/4
 angled	M12	5	5.0	■	125	SB-RGB SBP-RGB MB-RGB	Poly-urethane	■		VKHM-W-5/5 <sup>2)</sup>			
			10.0							VKHM-W-10/5 <sup>2)</sup>			
			3.0							VKHM-W-3/5-SB			
			5.0							VKHM-W-5/5-SB			
10.0	VKHM-W-10/5-SB												

	Size	Quantity of wires	Cable length (m)	Metal coupling ring	Max. permissible service voltage (V/AC/DC)	To be used for	Connector material	Cable material PVC, PU coating	Cable material PUR	Product description	Connector material	Cable material PVC	Product description
<b>Connection cable M12</b>													
 straight	M12	8	2.5	■	30		Poly-urethane	■	VKHM-Z-2.5/8 <sup>2)</sup>				
			5.0						VKHM-Z-5/8 <sup>2)</sup>				
 angled	M12	8	2.5	■	30		Poly-urethane	■	VKHM-W-2.5/8				
			5.0						VKHM-W-5/8 <sup>2)</sup>				
 straight	M12	12	5.0	■	30		Poly-urethane	■	VKSM-Z-5/12-A <sup>1,2)</sup>		PVC	■	VKHM-Z-10/12-A
			10.0						VKSM-Z-10/12-A <sup>1,2)</sup>				VKHM-Z-25/12-A
			15.0						VKSM-Z-15/12-A <sup>1,2)</sup>				VKHM-Z-30/12-A
			20.0						VKSM-Z-20/12-A <sup>1,2)</sup>				VKHM-Z-35/12-A
			25.0										
			30.0										
35.0													
 straight	M12	12	5.0	■	30		PVC	■	VKHM-Z-5/12-A <sup>1)</sup>				

<sup>1)</sup> Shielded cable

<sup>2)</sup> Drag chain compatible



	Size	Quantity of wires	Cable length (m)	Metal coupling ring	Max. permissible service voltage (V/AC/DC)	LED display	Connector material	Cable material PVC, PU coating	Cable material PUR	Product description	Connector material	Cable material PVC	Product description
<b>Connection cable M</b>													
 angled	M8	3	2.5	■	30	■	Poly-urethane	■	TKHM-W-2.5/LP		PVC	■	TKPM-W-2.5/LP
			5.0						TKHM-W-5/LP				TKPM-W-5/LP
			10.0						TKHM-W-10/LP				TKPM-W-10/LP
 straight	M12	4	2.5	■	31	■	Poly-urethane	■	VKHM-Z-2.5/4/LP		PVC	■	VKPM-Z-2.5/4/LP
			5.0						VKHM-Z-5/4/LP				VKPM-Z-5/4/LP
			10.0						VKHM-Z-10/4/LP				VKPM-Z-10/4/LP
 angled	M12	4	2.5	■	31	■	Poly-urethane	■	VKHM-W-2.5/4/LP		PVC	■	VKPM-W-2.5/4/LP
			5.0						VKHM-W-5/4/LP				VKPM-W-5/4/LP
			10.0						VKHM-W-10/4/LP				VKPM-W-10/4/LP

## Z-AT-VLE CONNECTING CABLES

Connecting cables with a two-sided plug connector are the optimal solution for putting all sensors, lighting as well as vision and ID products into operation. They feature a stable metal union nut, good insulation properties and a high protection type.

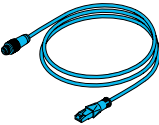

Technical data (typ.)	+20 °C, 24 VDC
Design	Straight / straight











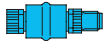

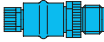

	Connection	Connection 2	Service voltage	Line length (mm)	Protection type	Cable material	Product description
<b>Connecting cables</b>							
	Socket, M12, 8-pin	Connector, RJ 45, 8-pin	30 V DC	1000	IP 67	Polyurethane	VKHM-Z-1/RJ45
	Socket, M12, 8-pin	Connector, RJ 45, 8-pin	30 V DC	2000	IP 67	Polyurethane	VKHM-Z-2/RJ45
	Socket, M12, 8-pin	Connector, RJ 45, 8-pin	30 V DC	5000	IP 67	Polyurethane	VKHM-Z-5/RJ45
	Socket, M12, 8-pin	Connector, RJ 45, 8-pin	30 V DC	10000	IP 67	Polyurethane	VKHM-Z-10/RJ45
	Socket, M12, 8-pin	Connector, RJ 45, 8-pin	30 V DC	20000	IP 67	Polyurethane	VKHM-Z-20/RJ45
	Socket, M12, 8-pin	Connector, RJ 45, 8-pin	30 V DC	30000	IP 67	Polyurethane	VKHM-Z-30/RJ45
	Socket, M12, 8-pin	Connector, RJ 45, 8-pin	30 V DC	30000	IP 67	Polyurethane	VKHM-Z-35/RJ45
	Connector, M12, 8-pin (X-coded)	Connector, RJ 45, 8-pin	30 V DC	2000	IP 20	Polyurethane	VSHM-Z-2/RJ45-X
	Connector, M12, 8-pin (X-coded)	Connector, RJ 45, 8-pin	30 V DC	5000	IP 20	Polyurethane	VSHM-Z-5/RJ45-X
	Connector, M12, 8-pin (X-coded)	Connector, RJ 45, 8-pin	30 V DC	10000	IP 20	Polyurethane	VSHM-Z-10/RJ45-X
	Connector, M12, 8-pin (X-coded)	Connector, RJ 45, 8-pin	30 V DC	15000	IP 20	Polyurethane	VSHM-Z-15/RJ45-X
	Connector, M12, 8-pin (X-coded)	Connector, RJ 45, 8-pin	30 V DC	20000	IP 20	Polyurethane	VSHM-Z-20/RJ45-X
	Connector, M12, 4-pin	Socket, M12, 4-pin	< 250 V AC/DC	600	IP 67	Polyurethane	VSHM-Z-0.6/VKM-Z/4
	Connector, M12, 3-pin	Socket, M12, 3-pin	< 250 V AC/DC	600	IP 67	Polyurethane	VSHM-Z-0.6/VKM-Z
	Connector, M12, 5-pin	Socket, M12, 5-pin	125 V AC/DC	600	IP 67	Polyurethane	VSHM-Z-0.6/VKM-Z/5
	Connector, M12, 12-pin	Socket, M12, 12-pin	< 30 V AC/DC	5000	IP 67	Polyurethane	VSSM-Z-5/VKM-Z/12
	Connector, M12, 8-pin (X-coded)	Connector, RJ 45, 8-pin	30 V DC	5000	IP 20	Polyurethane	VSSM-Z-5/RJ45-X

## Z-AT-AST ADAPTER PLUGS

Adapter plugs have a high protection type and are available in various designs. They are useful accessory parts for connecting sensors to existing and mechanically-incompatible connection cables.

Technical data (typ.)	+20 °C, 24 VDC
Max. voltage range (V)	24 V
Max. current-carrying capacity (A)	4.0 A











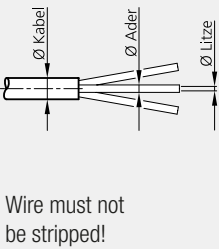
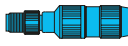

	<i>Coupling / number of pins</i>	<i>Connection diagram</i>	<i>Connector / number of pins</i>						<i>Product description</i>
	M8-3			M8-4					M8K3/M8S4
	M8-4			M8-3					M8K4/M8S3
	M8-3			M12-3					M8K/M12S
	M8-4			M12-4					M8K/M12S/4
	M12-3			M8-3					M12K/M8S
	M12-4			M8-4					M12K/M8S/4



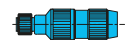

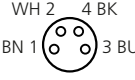
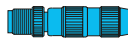

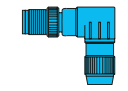

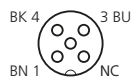
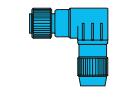

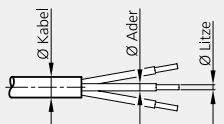



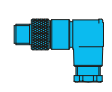





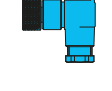

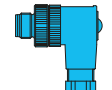

## Z-AT-SVK FIELD-ATTACHABLE PLUG CONNECTORS

Field-attachable plug connectors have a high protection type and are available in various designs. They are useful accessory parts for connecting sensors to existing and mechanically-incompatible connection cables.

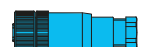

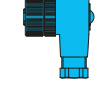
		Connection diagram (view of the connection side)	Connector / number of pins	Coupling / number of pins	Max. voltage range (V)	Ambient temperature (°C)	Clamping area Ø Cable (mm)	Clamping area Ø Wire (mm)	Cross-section of litz wires (mm <sup>2</sup> )	Product description
<b>Plug connector M8</b>										
		M8-3		32	-25 to +85	2.5 to 5.1	1.2 to 1.6	0.14 to 0.34	MS-Z-8/0.14	
						4.0 to 5.1		0.25 to 0.5	MS-Z-8	
		M8-4		32	-25 to +85	2.5 to 5.1	1.2 to 1.6	0.14 to 0.34	MS-Z-8/4/0.14	
						4.0 to 5.1		0.25 to 0.5	MS-Z-8/4	
		M8-3		32	-25 to +85	2.5 to 5.1	1.2 to 1.6	0.14 to 0.34	MK-Z-8/0.14	
						4.0 to 5.1		0.25 to 0.5	MK-Z-8	
		M8-4		32	-25 to +85	2.5 to 5.1	1.2 to 1.6	0.14 to 0.34	MK-Z-8/4/0.14	
						4.0 to 5.1		0.25 to 0.5	MK-Z-8/4	
<b>Plug connector M12</b>										
		M12-4		32	-25 to +85	2.9 to 5.1	1.2 to 1.6	0.14 to 0.34	MS-Z-12/4/0.14	
						4.0 to 5.1		0.25 to 0.5	MS-Z-12/4	
		M12-4		32	-25 to +85	4.0 to 5.1	1.2 to 1.6	0.25 to 0.5	MS-W-12/4	
		M12-4		32	-25 to +85	2.9 to 5.1	1.0 to 1.6	0.14 to 0.34	MK-Z-12/4	
		M12-4		32	-25 to +85	4.0 to 5.1	1.2 to 1.6	0.25 to 0.5	MK-W-12/4	

	Connection diagram (View of the connection side)	Connector / number of pins	Coupling / number of pins	Terminals	Solder connection	Max. voltage range (V)	Clamping area Ø Cable (mm)	Cross-section of litz wires (mm <sup>2</sup> )	Product description
<b>Plug connector M8</b>									
		M8-3		■		32	3.5 to 5.0	0.25 to 0.34	BS-Z-8/S
		M8-4							BS-Z-8/4/S
		M8-3			■	32	3.5 to 5.0	0.25 to 0.34	BS-W-8
		M8-4							BS-W-8/4
		M8-3		■		32	3.5 to 5.0	0.25 to 0.34	BK-Z-8/S
		M8-4							BK-Z-8/4/S
		M8-3			■	32	3.5 to 5.0	0.25 to 0.34	BK-W-8
		M8-4							BK-W-8/4
<b>Plug connector M12</b>									
		M12-4		■			4.0 to 6.0	0.75	BS-Z-12
		M12-5		■			4.0 to 6.0	0.75	BS-Z-12/5
		M12-4		■			4.0 to 6.0	0.75	BS-W-12
		M12-5		■			4.0 to 6.0	0.75	BS-W-12/5
		M12-4		■			4.0 to 6.0	0.75	BK-Z-12
		M12-5		■			4.0 to 6.0	0.75	BK-Z-12/5
		M12-4		■			4.0 to 6.0	0.75	BK-W-12
		M12-5		■			4.0 to 6.0	0.75	BK-W-12/5



## Signal preparation

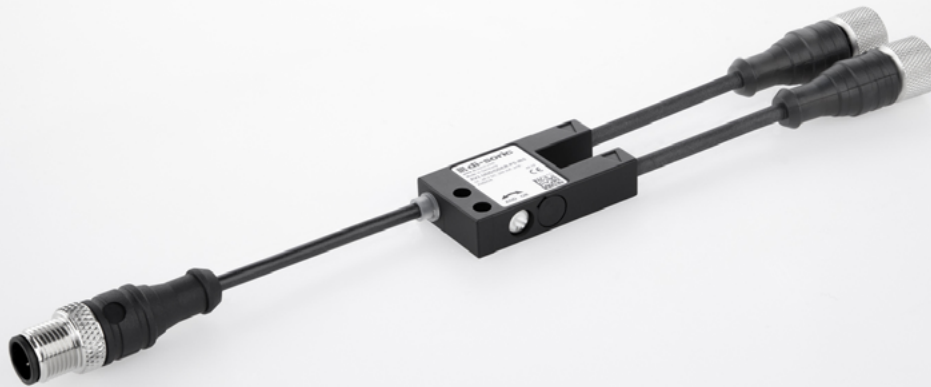

di-soric offers high-quality function adapters and logic distributors for various applications. Logic distributors can logically connect several sensors together and output the desired behavior accordingly, for example an AND/OR function. Function adapters can change sensor-specific functions to the desired function (e.g. pulse stretching).

Z-SA-FA Function adapters

203

Z-SA-LV Logic distributors

205

## Z-SA-FA FUNCTION ADAPTERS

Function adapters can change sensor-specific properties to the desired function (e.g. pulse stretching). They are suitable for all conventional sensors, feature a compact design and can be retrofitted quickly and easily.

### Technical data (typ.)

**+20 °C, 24 VDC**

Service voltage	10 to 35 V DC
Current-carrying capacity	200 mA, short-circuit proof
No-load current	20 mA
Ambient temperature	-20 to +70 °C
Protection type	IP 67
Protection class	III, operation on protective low voltage

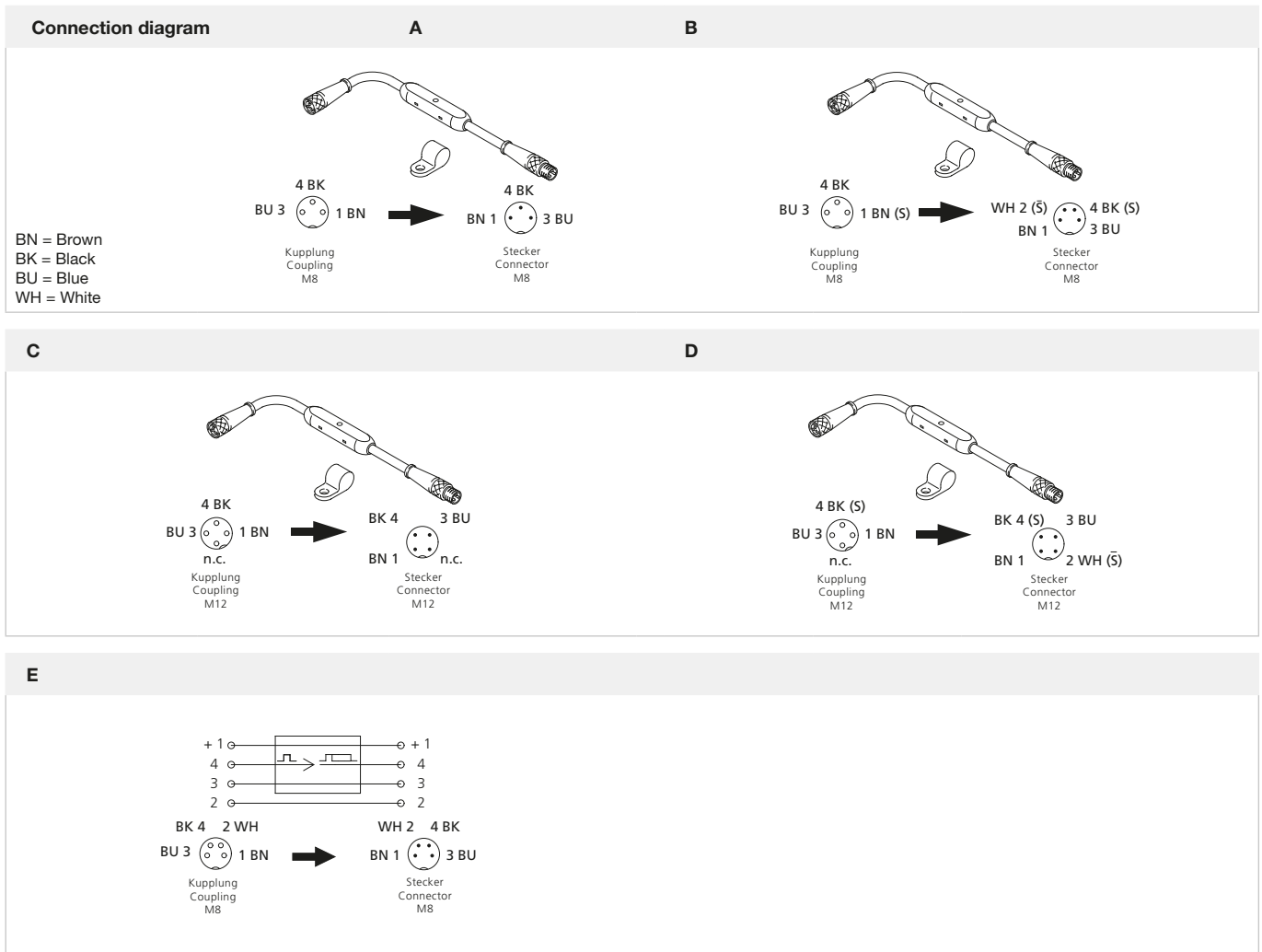

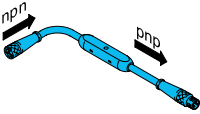
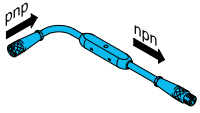
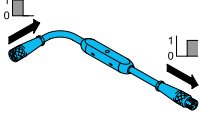
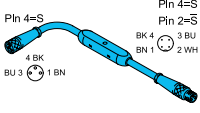
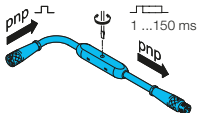
	Minimum pulse length (ms)	Output	Switching frequency (Hz)	Connection diagram (the opposite side)	Coupling	Connector	Product description
<b>npn threshold switch</b>							
	0.1	npn	<5,000Hz	A	M8/3-pin	M8/3-pin	TKHM-Z/TSM-Z/UN
				C	M12/3-pin	M12/3-pin	VKHM-Z/VSM-Z/UN
<b>npn ⇌ npn converter</b>							
	0.1	npn	<5,000Hz	A	M8/3-pin	M8/3-pin	TKHM-Z/TSM-Z/U
				C	M12/3-pin	M12/3-pin	VKHM-Z/VSM-Z/U
<b>npn inverter</b>							
	0.1	npn	<3,500Hz	A	M8/3-pin	M8/3-pin	TKHM-Z/TSM-Z/I
				C	M12/3-pin	M12/3-pin	VKHM-Z/VSM-Z/I
<b>npn antivalence device</b>							
	0.1	npn	<3,500Hz	B	M8/3-pin	M8/4-pin	TKHM-Z/TSM-Z/P4
				D	M12/3-pin	M12/4-pin	VKHM-Z/VSM-Z/P4
<b>npn pulse stretcher</b>							
	0.1	npn 1 to 150ms	<500Hz	A	M8/3-pin	M8/3-pin	TKHM-Z/TSM-Z/T
				E	M8/4-pin	M8/4-pin	TKHM-Z/TSM-Z/T4
				C	M12/3-pin	M12/3-pin	VKHM-Z/VSM-Z/T

## Z-SA-LV LOGIC DISTRIBUTORS

Logic distributors can logically link several sensors together and feature a switchable AND/OR switching function. With their high protection type, they can be easily retrofitted and can be used in a large range of temperatures.

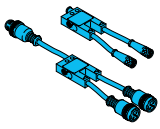

Double logic distributor			
	Connection voltage	10 to 35 V	
	Switching output	pnp, 200 mA, AND/OR	
	Switching frequency	6,000 Hz	
	Protection type	IP 67	
	<b>Type</b>		<b>Product description</b>
	Logic distributor M8, AND/OR switchable		AV2-AND/OR-PS-TS
Logic distributor M12, AND/OR switchable		AV2-AND/OR-PS-IBS	

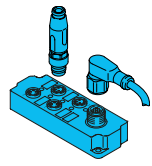
Quadruple logic distributor			
	Connection voltage	10 to 30 V	
	Current-carrying capacity AND/OR	For each 300 mA/logic contact	
	Switching output	pnp 4x, pnp-AND 1x, pnp-OR 1x	
	Protection type	IP 67 (for use of all slots)	
	<b>Type</b>		<b>Product description</b>
	AND-M8 dummy plug		BS-Z-8-UND
Logic distributor M8, quadruple		AV4-AND/OR	

## Universal mounting technology



di-soric offers various tailored and flexible-to-use clamping joint and ball joint brackets for all sensors, image processing and identification systems as well as lighting.

Z-UBT-KL-MS Assembly system for clamping brackets	207
Z-UBT-KL-PH Product bracket for clamping bracket	210
Z-UBT-KU-MS Assembly system for ball system	213
Z-UBT-KU-PH Product bracket for ball system	213
Mounting examples system holder, basic holder	214



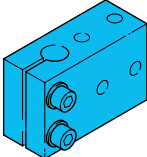
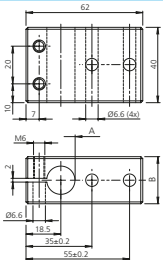
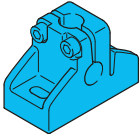
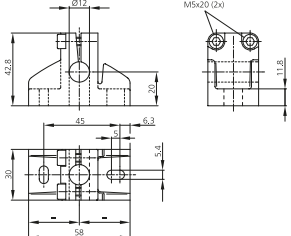
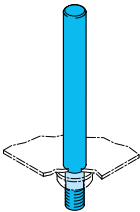
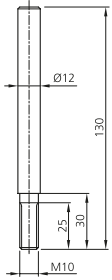
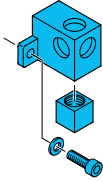
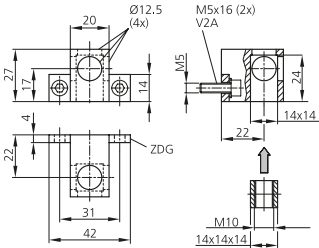

## Z-UBT-KL-MS ASSEMBLY SYSTEM FOR CLAMPING BRACKETS

The comprehensive range of assembly systems meets the most common requirements for fixed mounting by means of basic holders, tube, rods, adapter rings, joint arms, angular clamps, and cross connectors.

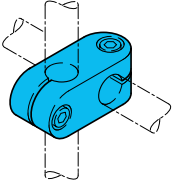
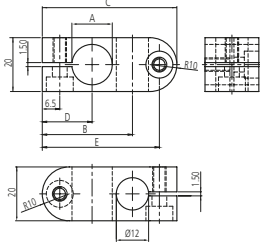
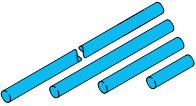
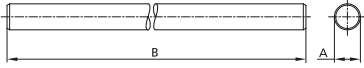
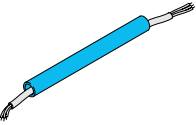
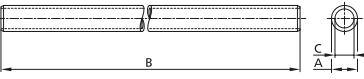
		A (mm)	B (mm)	C (mm)	D (mm)	E (mm)	Material	Product description
<b>Basic holder</b>								
		12	20				Aluminum	HS-GH-12-A
		15	25					
<b>Basic holder</b>								
							Aluminum	HS-GH-3-12-A
<b>Mounting rod Ø 12mm</b>								
							Stainless steel	HS-S-12-130-M10
<b>Basic holder for mounting rod HS-S-12-130-M10</b>								
							Die-cast zinc	HS-GH-12

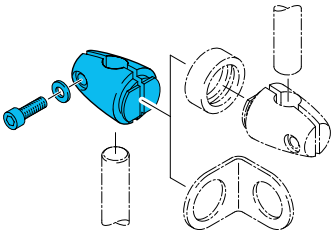
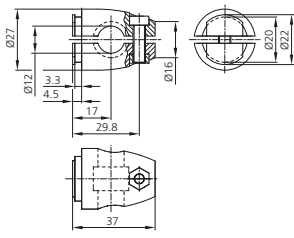
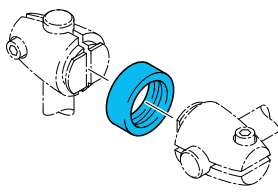
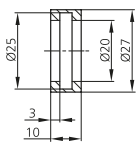
		A (mm)	B (mm)	C (mm)	D (mm)	E (mm)	Material	Product description
<b>Cross connector</b>								
		Ø10	31.5	48	16.5	41.5	Aluminum	HS-K-10-12-A
		Ø12	31.5	48	16.5	41.5		HS-K-12-12-A
		Ø14	33.5	50	18.5	43.5		HS-K-14-12-A
		Ø15	33.5	50	18.5	43.5		HS-K-15-12-A
<b>Mounting rods</b>								
		Ø12	100				Stainless steel	HS-S-12-100-V
		Ø12	200					HS-S-12-200-V
		Ø12	500					HS-S-12-500-V
		Ø15	100					HS-S-15-100-V
		Ø15	200					HS-S-15-200-V
		Ø15	500					HS-S-15-500-V
<b>Mounting tube</b>								
		Ø15	150	12			Stainless steel	HS-R-15-150-V

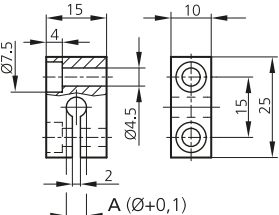
		A (mm)	B (mm)	Material	Product description
<b>Clamping cylinder for mounting rods <math>\varnothing 12</math> mm</b>					
			$\varnothing 12.5 / \varnothing 20$	Stainless steel	HS-KL-12-20-V
<b>Adapter ring for connecting two clamping cylinders</b>					
			$\varnothing 20 / \varnothing 20$	Stainless steel	HS-AR-KL-20
<b>Terminal block</b>					
					
				A = 8.0 mm	KB 8

## Z-UBT-KL-PH PRODUCT BRACKET FOR CLAMPING BRACKET

The product brackets are designed for the assembly of all sensors. They are characterized by a robust construction and simple and reliable assembly.

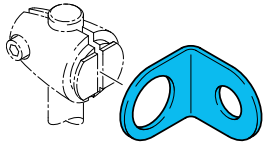
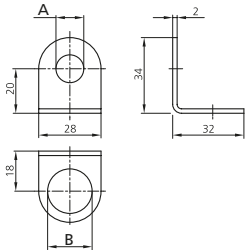
		A (mm)	B (mm)	Material	Product description
<b>Mounting bracket</b>					
		Ø 12.5	Ø 20	Stainless steel	HS-BW-12
		Ø 18.5	Ø 20		HS-BW-18

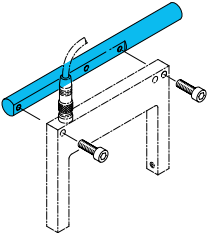
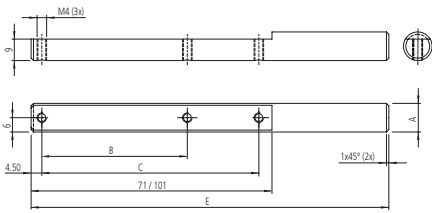
		A (mm)	B (mm)	C (mm)	D (mm)	E (mm)	Material	Product description
<b>Product holder</b>								
		Ø 12	61	-	120	Stainless steel	HS-PH-12-120-V	
		Ø 18	61	91	150		HS-PH-12-150-V	

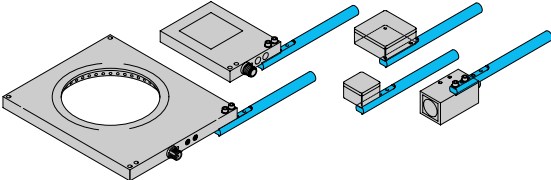
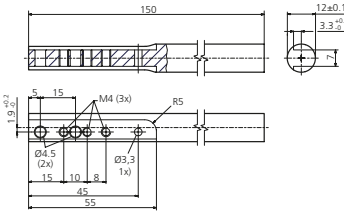
		Material	Product description
<b>Universal holder for lights</b>			
		Area lights	
		Barlights	
		Spotlights	
Dark field lights			
Material: Stainless steel	SH-U1-12-150-V		

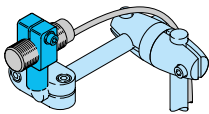
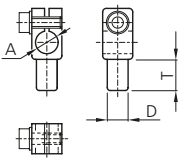
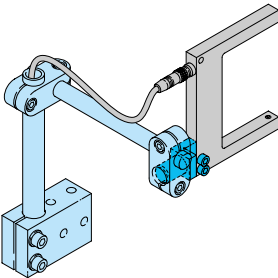
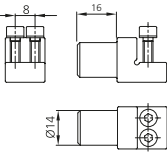
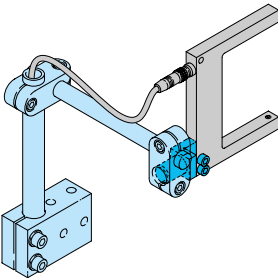
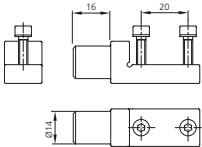
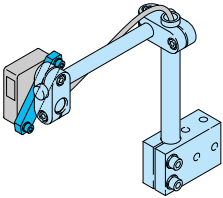
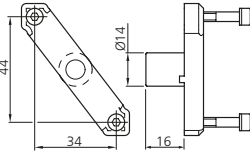
		A (mm)	D (mm)	T (mm)	Material	Product description
<b>Holder for cylindrical housing designs</b>						
		6.5	10	16	Polyamide	SH-6.5-10
		8	10	16		SH-8-10
		12	10	16		SH-12-10
<b>Holders for fork and angled light barriers</b>						
		For angled light barriers OGL...-TSSL OGLP...-TSSL		Plastic	SH-UGU-08-14	
		For fork light barriers Fork width of up to 100mm				
		For fork light barriers Fork width of 100mm or greater		Plastic	SH-UGU-20-14	
<b>Holder for light barriers in the 50 housing series</b>						
		For light barriers in the 50 housing series		Plastic	SH-S50-34-44-14	

**Basic holder for barlights and coaxial lights**

Barlights	
Coaxial lights	
Material: Aluminum	SH-G-BE

**Holder for area lights, spotlights and dark field lights**

Area lights	
Spotlights	
Dark field lights	
Material: Aluminum	SH-BEK

## Z-UBT-KU-MS ASSEMBLY SYSTEM FOR BALL SYSTEM

The assembly systems stand out for their robust construction and simple and reliable assembly.

	Size	Material	Scope of delivery	To be used for	Product description
<b>System holder for lighting</b>					
	35 x 25 mm	Aluminum	Ball housing, mounting material	Z-UBT-KU-MS, Z-UBT-KU-PH	HS-AG-HM-KF-VS
	30 x 20 mm	Aluminum	Ball head, fastening material	Z-UBT-KU-MS	HS-AG-HM-KK-VS-M6
	36 x 26 x 55 mm	Aluminum	Ball head, assembly plate	Barlights BE-A65 ..., Barlights BE-A130 ..., Barlights BE-A240 ...	HS-AG-HM-MP- KK
	M6 / M8	Metal	Adapter screw	BE 1-Axxx frame set	HS-AG-NG-AD-VS-M6
	L1 = 215 mm, L2 = 165 mm	Aluminum	Bracket arm, ball housing	Z-UBT-KU-MS, Z-UBT-KU-PH	HS-AG-NG-HA-VS-M6
	65 x 92 mm	Aluminum	Suction cup, ball head, adapter screw	Z-UBT-KU-MS	HS-AG-NG-KK-VS-M8/M6
	190 x 160 mm	Aluminum	Ball head, adapter screw, clamp	Z-UBT-KU-MS	HS-AG-NG-KL-VS-M6

## Z-UBT-KU-PH PRODUCT BRACKET FOR BALL SYSTEM

The product brackets stand out for their robust construction and simple and reliable assembly.

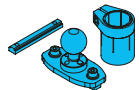
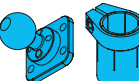
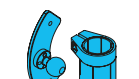
	Size (mm)	Material	Scope of delivery	To be used for	Product description
<b>System holder for lighting</b>					
	50.0 x 6.9 x 4.6	Aluminum	1 slot nut (BEK-A), 1 ball-shaped head (with foot plate), 1 ball housing, mounting material	BEK-A	HS-BE-A-NS-TN-M4
	30.0 x 32.0 x 35.0	Aluminum	1 adapter plate (BEK-P), 1 ball-shaped head, 1 ball housing, mounting material	BEK-P	HS-BE-P-MP-KK-M4
	29.0 x 35.0	Aluminum	1 adapter plate (BEK-R70), 1 ball-shaped head, 1 ball housing, mounting material	BEK-R70	HS-BE-R-MP-KK-M4

### Mounting examples system holder, basic holder

Ø 12mm

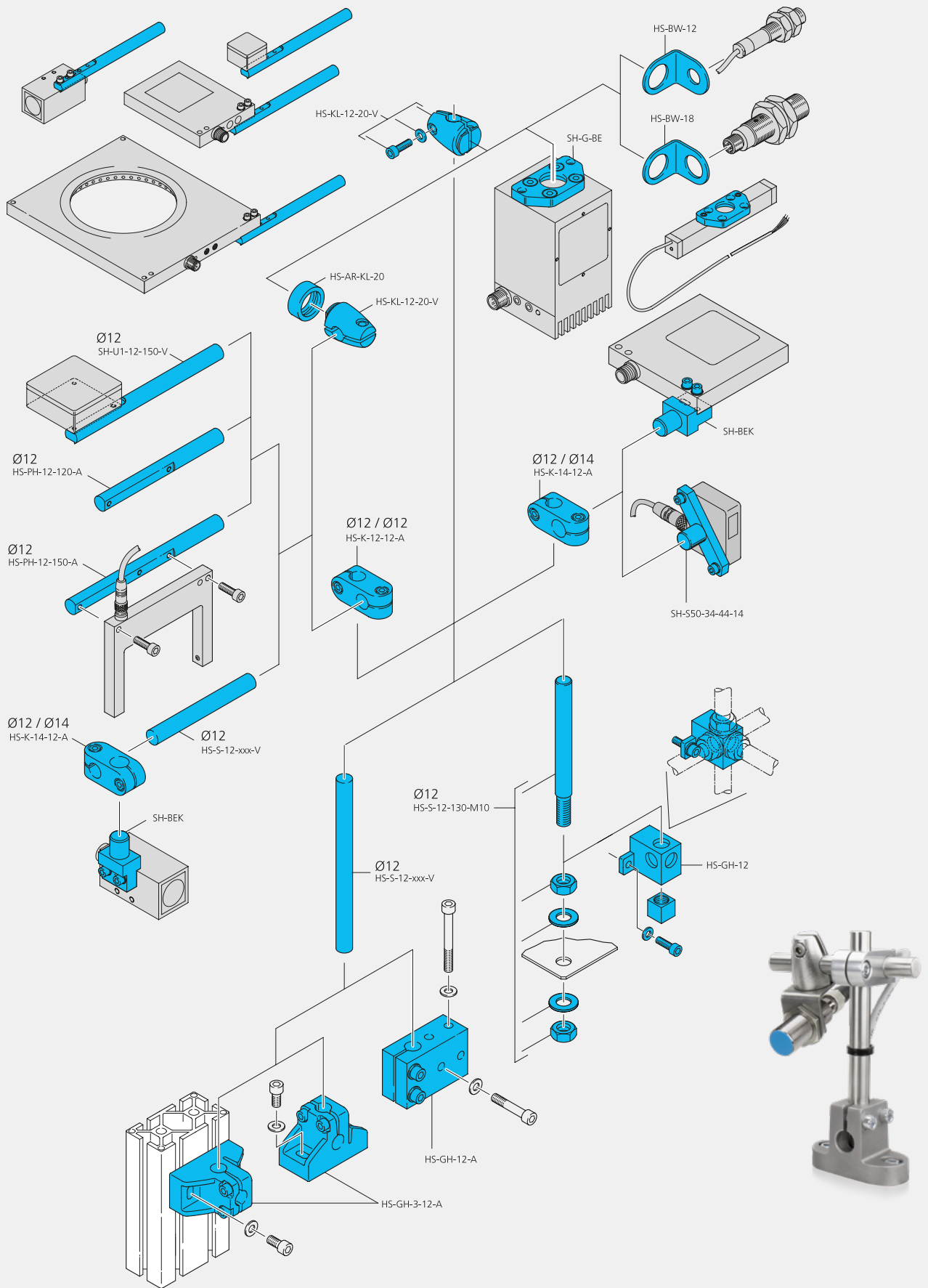



### Mounting examples system holders, basic holder

Ø 15mm

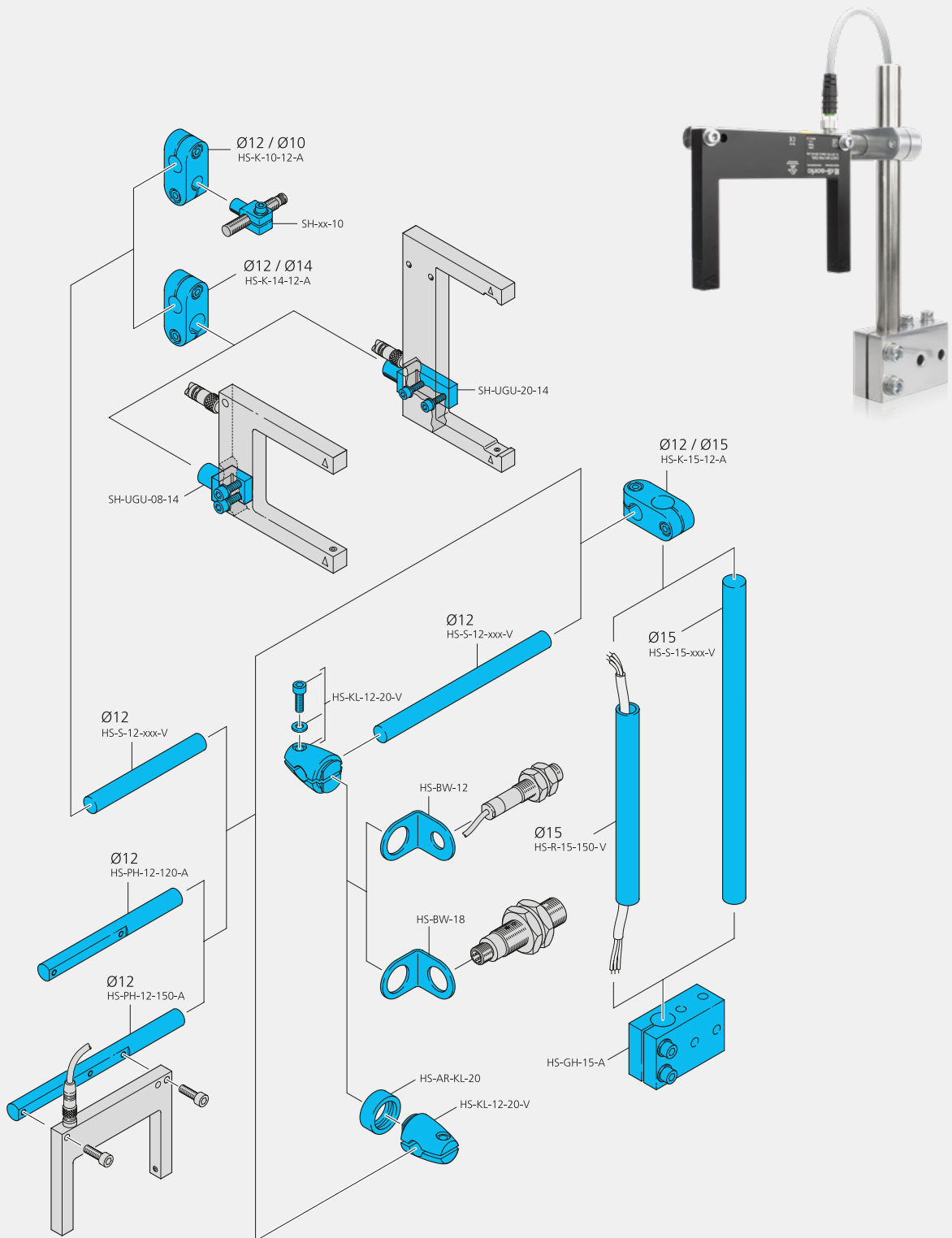

## Test & parameterization devices



di-soric offers smart and high-quality testing and parameterization devices for any and all sensors and lighting. The IOL-Portable handheld device enables you to operate IO-Link sensors without additional hardware. The sensor tester is used to test the proper functioning of pnp and npn sensors.

Z-PP-IOL-M IO-Link Master	217
Z-PP-IOL-P IO-Link Portable	218
Z-PP-ST Sensor tester	219

## Z-PP-IOL-M IO-LINK MASTER

The IOL Portable handheld device enables the display of measured values as well as the diagnosis and the configuration of IO-Link sensors and devices without additional control. The IOL-Master was designed for operation on a Windows PC.



### We have set up 3 user levels in IODD for you:

- OPERATOR  
View only
- MAINTENANCE  
Teach-in and modification of approved settings
- SPECIALIST  
Full access to all available setting options

**Only the relevant setting options** are provided in the IODD, as opposed to the exhaustive, full listing of all options, which would be confusing.

**The IODD was completely** developed in accordance with the Smart Sensor Profile, thus making it possible to configure the sensor directly over the PLC without additional parameterization software. The Smart Sensor Profile describes the assignment of the most important indices and sub-indices, thereby enabling devices to be addressed directly by means of the master if the IODD is not available.

### Software that does away with lengthy explanations

You know intuitively what each property represents.

### Technical data

USB	USB 2.0 (Mini USB B)
Power supply	5 V / 500 mA (PC USB) 24 V / 80 mA (IO-Link device from USB) 24 V / 1 A (IO-Link device from the power supply)
Protected against polarity reversal	Yes
Protection class	III
IO-Link communication	IO-Link specification V1.1
IO-Link port class	A
Temperature range for operation	0 to 45 °C
Storage temperature	-40 to 80 °C
Protection type	IP 20

### IO-Link device

Scope of delivery: IO-Link device tool -USB A-B cable -AC adapter (24V/24W) -"Read Me First" document	IOL master
---	------------

### Accessories

Connection cable (coupling M12, 4-pin / M12 connector, 4-pin)	VSHM-Z-0.6/VKM-Z/4
Adapter plug (coupling M8, 3-pin / connector M12, 3-pin)	M8K/M12S
Adapter plug (coupling M8, 4-pin / connector M12, 4-pin)	M8K/M12S/4

### System requirements for operating the IO-Link device tool V 4.0 software

<b>Computer</b> Computer with an available USB 1.1 or 2.0 interface Ethernet network interface	<b>Operating System</b> Windows 7 32/64 bit Service Pack 1 Windows 8.1 32/64 bit Windows 10 64 bit Microsoft.Net Framework 3.5
<b>Monitor</b> Resolution of 1024x768 or higher	

## Z-PP-IOL-P IO-LINK PORTABLE

The IOL Portable handheld device enables the display of measured values as well as the diagnoses and the configuration of IO-Link sensors without additional control. The handheld device enables you to operate IO-Link sensors without additional hardware.



### We have set up 3 user levels in IODD for you:

- **OBSERVER**  
Identification, observe, diagnosis
- **MAINTENANCE**  
Identification, observe, diagnosis, parameter (basic)
- **SPECIALIST**  
Full access to all provided setting options
- Universal IO-Link handheld master
- App-based, no prior knowledge necessary
- Integrated touchscreen and plug connectors
- Integrated battery, IO-Link master and WLAN
- For identification, configuration and diagnostics
- IODD download via IODDfinder
- For devices with IODD Specification 1.1

<b>Technical data</b>	+20°C, 24 VDC
Power consumption	80 mA
Inverse polarity protection	Yes
Power supply	24V / 80 mA (IO-Link device from battery)
Housing dimensions	62 x 222 x 90 mm
Housing material	Polycarbonate
Protection class	III, operation on protective low voltage
To be used for	For devices with IODD Specification 1.1
Functions	Without PC
Communication	IO-Link specification V 1.1, IO-Link port class A
Ambient temperature during operation	0 to +40 °C
Protection type	IP 30
Connection	Socket, M8, 3-pin
Connection 2	Socket, M8, 4-pin
Connection 3	Socket, M12, 4-pin

IOL Portable	
Scope of delivery: -IO-Link handheld master -Cable with clamps 0.3m with M12 connector, 4-pin -Protective bag -Micro-USB cable -Quickstart instructions	IOL Portable

Accessories	
Connection cable (coupling M12, 4-pin / M12 connector, 4-pin)	VSHM-Z-0.6/VKM-Z/4

## Z-PP-ST SENSOR TESTER

The sensor tester is used to test the proper functioning of pnp and npn sensors. The output signal is output both optically and acoustically. Quick connect sockets and the internal battery power supply ensure quick, flexible use.



Sensor tester for pnp, npn and push-pull sensors		
	Size without protective casing	135 x 76 x 27 mm
	No-load current	< 40 mA
	Output voltage	18 V DC
	Display	LED: green - operation, yellow - switching outputs
	Protection type	IP 21
	Housing material	ABS, black plastic
	Material	Silicone (protective casing)
	Connection	Color-coded quick-action sockets
	Current limiting	60 mA in battery operation 240 mA in operation with external power supply
	Power supply	1.5 V batteries type AA (3x) External 12 V DC power supply (optional)
	Weight	295 g
		ST 7PNG

ST-AS connection set For testing sensors with a switching output and M8 or M12 connector		
	-Connection cable with coupling M12, 4-pin	
	-Adapter plug coupling, M8, 3-pin / connector M12, 4-pin (1x)	
	-Adapter plug coupling, M8, 4-pin / connector M12, 4-pin (1x)	
		ST-AS

Power supply for operation at 220V		
	Output voltage	12 VDC, 2000 mA
	Connection voltage	100-240 VAC, 50-60 Hz, 800 mA
		ST-PS-12V

## Sensor accessories









The wide range of di-soric accessories offers the optimum solution for embedding and commissioning common sensors into machines and systems.

O-Z-REF Reflectors - reflective films	221
FS-Z Color sensor accessories	222
KLS-Z Plastic fiber-optic sensor accessories	226
MZE-Z Magnetic field sensor accessories	227

## O-Z-REF REFLECTORS - REFLECTIVE FILMS

Retro reflective sensors require matching reflectors and reflective foils for operation. Reflectors from di-soric are optionally available for laser or LED light sources. Various sizes and specific designs round off the range.

	Housing design Size (mm)	Mounting	For sensors with red light / infrared	For sensors with laser light	Temperature stability (°C)	Product description
<b>Reflectors for infrared and red light</b>						
	Ø 10x5.8	M3 x 8.4	■		-20 to 60	R 10 M3
	Ø 19x5.8	M3 x 9	■		-20 to 60	R 21 M3
	Ø 42x7	adhesive	■		-20 to 60	R 42
	Ø 50x8	adhesive	■		-20 to 60	R 50
	69 x 50 x 9	Ø5mm (2x)	■		to 80	R 46
	Ø 84x7.4	Ø4.5mm (1x)	■		-20 to 60	R 84
	19 x 54 x 9.4	adhesive	■		-20 to 60	R 19x54
	50 x 80 x 7.2	adhesive	■		-20 to 60	R 50x80
	51 x 95 x 8	Ø3.3mm (2x)	■		to 500	R 51x94/500°
	100 x 100 x 9	Ø 3.8 (2x)	■		-20 to 60	R 100x100
	100 x 100 x 9	Ø3.8mm (2x)	■		to 150	R 100x100/150°
	Width of 50	self-adhesive	■		-20 to 60	RFP 50/... m

<b>Reflectors and reflective foil for laser light</b>						
	12.8 x 16.8 x 4.2	adhesive		■	Up to 60	RL 13x17
	42 x 35 x 8.4	Ø 3.3 (2x)		■	Up to 60	RL 42x35
	43 x 20 x 3.5	Ø 3.3 (2x)		■	Up to 110	RL 43x20/110°
	30 x 45 x 5.5	Ø 3.3 (2x)		■	Up to 70	RL 45x30
	50 x 230	adhesive		■	Up to 60	RFPL 50x230



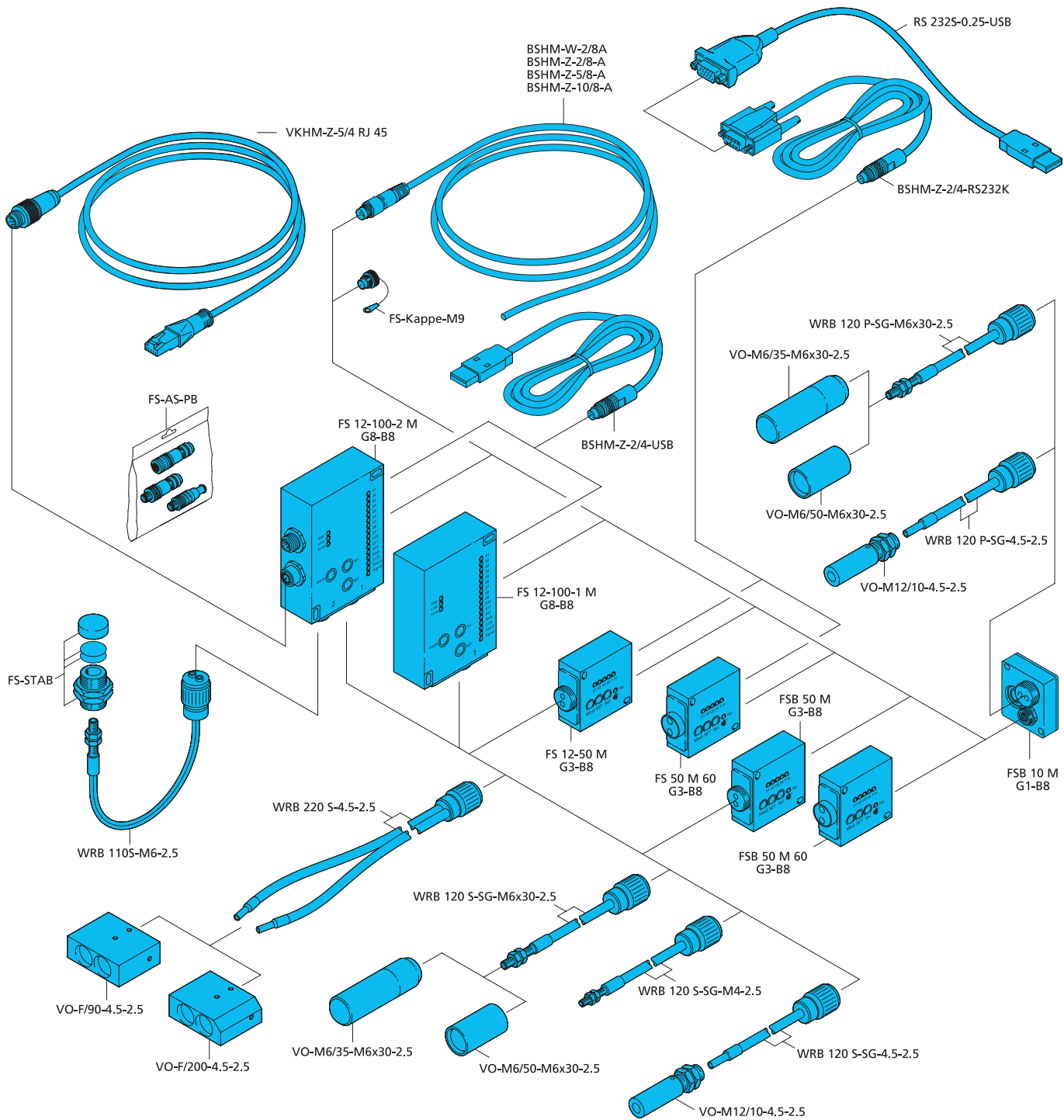

The specified range can be reduced by up to 50% compared to the referring reflector.

## FS-Z COLOR SENSOR ACCESSORIES

For a clear distinction between small differences in color, color sensors require high-performance accessories from the FS-Z Series. Fiber optic conductors, focus optics, connection technology, and further accessories are coordinated with di-soric color sensors.

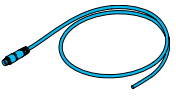

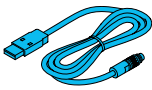
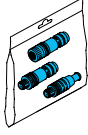
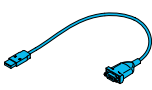
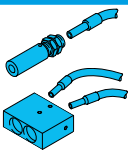
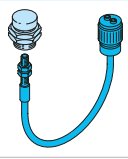

	FSB 10 M G1-B8	FSB 50 M 60 G3-B8	FSB 50 M G3-B8	FS 50 M 60 G3-B8	FS 50 M G3-B8	FS 12-100-1 M G3-B8	FS 12-100-1 M G3-B8-E	FS 12-100-2 M G3-B8	FS 12-100-2 M G3-B8-PB	Connections	Cable length (m)	Protection type	Product description
<b>Connection cable</b>													
	■	■	■	■	■	■	■	■	■	Angled M9 connector, 8-pin / flying leads	2.0	IP 67	BSHM-W-2/8A
	■	■	■	■	■	■	■	■	■	Straight connector M9, 8-pin / flying leads	2.0	IP 67	BSHM-Z-2/8A
	■	■	■	■	■	■	■	■	■		5.0	IP 67	BSHM-Z-5/8A
	■	■	■	■	■	■	■	■	■		10.0	IP 67	BSHM-Z-10/8A
<b>Connection cable for computer, connection set for Profibus / Ethernet</b>													
			■	■	■	■	■	■	■	computer / RS 232	2.0		BSHM-Z-2/4-RS232K
						■	■	■	■	computer / USB	2.0		BSHM-Z-2/4-USB
									■	computer / Profibus	M12, B-coded		FS-AS-PB
<b>Adapter RS232 / USB</b>													
			■	■	■	■	■	■	■	USB / RS 232	0.25		RS232S-0.25-USB
<b>Fiber-optic cables / focus optics</b>													
	■	■	■	■	■	■	■	■	■				Article see "Fiber-optic cables / focus optics" on page 224
<b>Stabilization system</b>													
							■	■			0.3	IP 67	WRB 110 S-M6-2.5
							■	■					FS-STAB

### Fiber-optic cables / focus optics

Glass fiber-optic cables feature a robust design.

One- or two-armed fiber-optic cables with different sensor probes are available.

Focus optics focus the light beam down to a small measuring spot diameter and enable color measurement on very small surfaces.

The operating range of the focus optics is 10 to 300 mm.

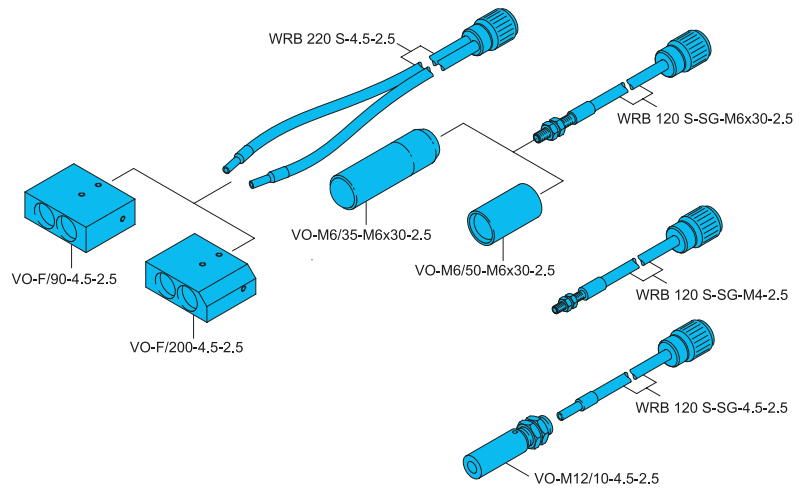

#### Technical data (typ.)

##### Focus optics

Fiber bundle	Ø 2.5 mm
Material of focus optics	Aluminum, anodized

#### Focus optics for operation with 1-arm fiber

VO-M12/10-4.5-2.5

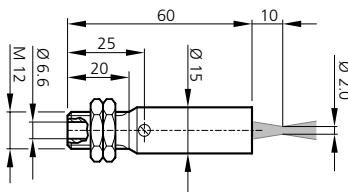

VO-M6/35-M6x30-2.5

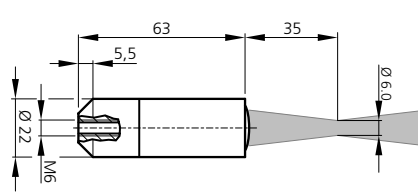

VO-M6/50-M6x30-2.5

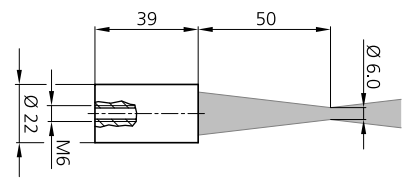

#### Focus optics for operation with 2-arm fiber

VO-F/90-4.5-2.5

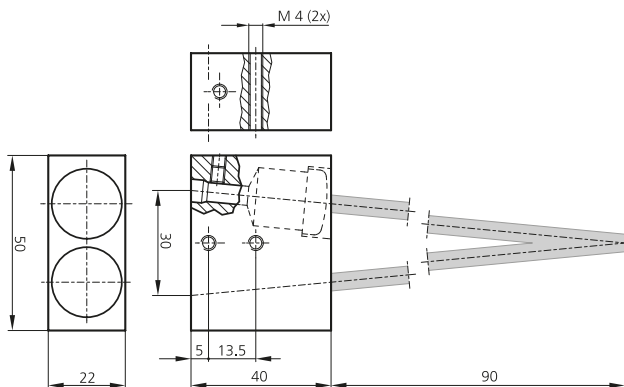



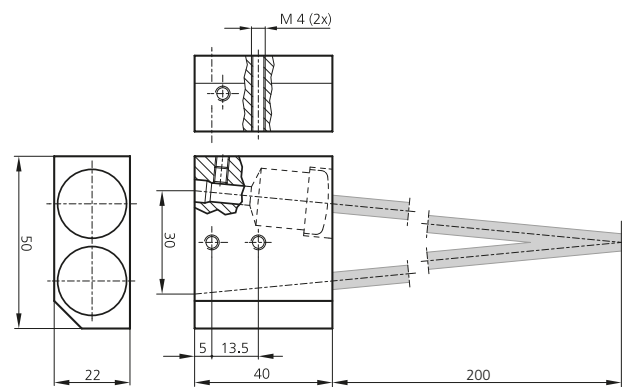







VO-F/200-4.5-2.5



mm (typ.)







Technical data (typ.)		
Fiber-optic cable	WRB 120 S-SG... / WRB 220 S-4.5-2.5	WRB 120 P-SG...
Active Ø	Ø 2.5mm	Ø 2.5mm
Protection type	IP 67	IP 67
Bending radius	≥ 3 x tube Ø	≥ 2 x tube Ø
Material of sensor probe	VA	VA
Material of fibers	Glass fibers	Glass fibers
Material of sheathing	Silicone-metal sleeve	PVC
Length of fiber-optic cable	600mm	600mm

Fiber optics and matching focus optics															
		FSB 10 M G1-B8	FSB 50 M G3-B8	FS 50 M G3-B8	FS 12-100-1 M G3-B8	FS 12-100-2 M G3-B8 / ... G3-B8-PB	Fastening for fiber-optic cable / focus optics	Measuring spot Ø (mm)	Working distance (mm)	Length (mm)	Single fiber (mm)	Operating range (mm)	Opening angle	Temperature resistance (°C)	Product description
	Fiber optics	■	■	■	■	Ø4.5			600	0.05 <sup>1)</sup>		67°	-40 to +180	WRB 120 S-SG-4.5-2.5	
	Fiber optics	■				Ø4.5			600			68°	+80	WRB 120 P-SG-4.5-2.5	
	Focus optics	■	■	■	■	Ø4.5	2.0	10			10 to 15			VO-M12/10-4.5-2.5	
	Fiber optic cable:	■	■	■	■	M4			600			67°	-40 to +180	WRB 120 S-SG-M4-2.5	
	Fiber optics	■	■	■	■	M6			600	0.05 <sup>1)</sup>		67°	-40 to +180	WRB 120 S-SG-M6x30-2.5	
	Fiber optics	■				M6			600			68°	+80	WRB 120 P-SG-M6x30-2.5	
	Focus optics	■	■	■	■	M6	6.0	35			30 to 60			VO-M6/35-M6x30-2.5	
	Focus optics	■	■	■	■	M6	6.0	50			35 to 60			VO-M6/50-M6x30-2.5	
	Fiber optic cable:	■	■	■	■	Ø4.5			600	0.05		67°	-40 to +180	WRB 220 S-4.5-2.5	
	Focus optics	■	■	■	■	Ø4.5	14	90			70 to 150			VO-F/90-4.5-2.5	
	Focus optics	■	■	■	■	Ø4.5	20	200			150 to 300			VO-F/200-4.5-2.5	

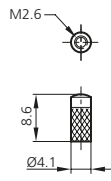
<sup>1)</sup>Fiber arrangement statistically mixed

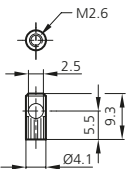
## KLS-Z PLASTIC FIBER-OPTIC SENSOR ACCESSORIES

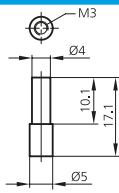
The KLS-Z series offers accessories for the KL series of plastic fiber optics. Optical heads for range extension, focusing, beam deflection, and further accessories are coordinated with di-soric plastic fiber optics

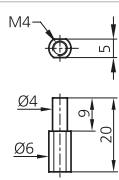
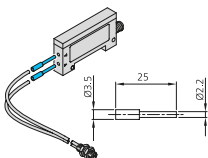
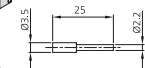
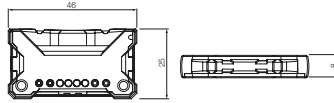
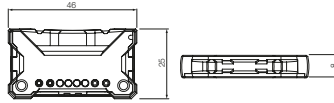
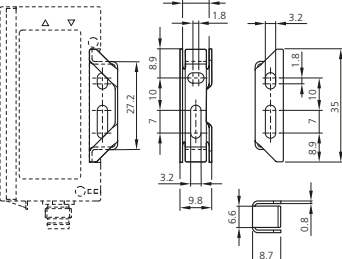
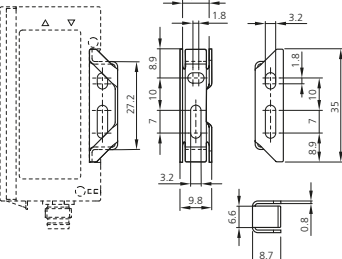
			Light aperture	Thread	Quantity	Product description
<b>Attachment optics for increasing the range for through-beam light barriers with sensor probe thread</b>						
	 <p>M2.6 8.6 Ø4.1</p>	<p>To increase the range by up to 400%, installed on the sensor probe of the transmitter.</p>				
			Axial	M2.5	1	VO M 2.5
Axial	M2.6	1	VO M 2.6			
	 <p>M2.6 2.5 5.5 9.3 Ø4.1</p>	<p>For beam deflection, installed on the sensor probe of the transmitter.</p>				
			Radial	M2.5	1	VO M 2.5-90
Radial	M2.6	1	VO M 2.6-90			
<b>Attachment optics for light spot focus for light sensors with sensor probe thread</b>						
	 <p>M3 Ø4 10.1 17.1 Ø5</p>	<p>For light spot focus, the light spot size is Ø0.5 at a distance of 8mm.</p>				
			Axial	M3	1	VO M3
	 <p>M4 5 Ø4 9 Ø6 20</p>	<p>For light spot focus, the light spot size is Ø0.7 at a distance of 10mm.</p>				
			Axial	M4	1	VO M4
<b>Adapter</b>						
	 <p>25 Ø3.5 Ø2.2</p>	<p>For Ø 1 mm plastic fiber-optic cables Set consists of two pieces.</p>				
					2	AK 2.2/1
<b>Cutting knife for plastic fiber-optic cables that can be cut to size</b>						
	 <p>46 25 8</p>					
						SM2
<b>Fastening bracket for fiber-optic sensors</b>						
	 <p>8.2 1.8 3.2 8.5 7 10 77.2 3.2 9.8 6.6 8.7 0.8 3.5 1.15 0.1 9.9 7</p>					
			For OLVK 61 ...			BW 60

## MZE-Z MAGNETIC FIELD SENSOR ACCESSORIES

The MZE-Z series offers various fastening accessories, such as sensor clips and adapters, which are matched specifically with our di-soric magnetic field sensors.

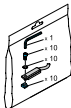
	Type of groove	To be used for cylinder/piston diameter [mm]	Scope of delivery	To be used for	Product description
<b>Sensor clip for magnetic field sensors</b>					
	T-groove	8	Sensor holder, mounting material		MZ-S-8/6.5
	T-groove	10	Sensor holder, mounting material		MZ-S-10/6.5
	T-groove	12	Sensor holder, mounting material		MZ-S-12/6.5
	T-groove	16	Sensor holder, mounting material		MZ-S-16/6.5
	T-groove	20	Sensor holder, mounting material		MZ-S-20/6.5
	T-groove	25	Sensor holder, mounting material		MZ-S-25/6.5
	T-groove	32	Sensor holder, mounting material		MZ-S-32/6.5
	T-groove	40	Sensor holder, mounting material		MZ-S-40/6.5
	T-groove	50	Sensor holder, mounting material		MZ-S-50/6.5
	T-groove	63	Sensor holder, mounting material		MZ-S-63/6.5
	T-groove	110	Sensor holder, mounting material		MZ-SB100
<b>Sensor claw for magnetic field sensors</b>					
	T-groove	32 – 40	Sensor claw, mounting material		MZ-K-6/6.5
	T-groove	50 – 63	Sensor claw, mounting material		MZ-K-8/6.5
	T-groove	80 – 100	Sensor claw, mounting material		MZ-K-10/6.5
	T-groove	32 – 40	Sensor claw, mounting material		MZ-K-11/6.5
	T-groove	50 – 63	Sensor claw, mounting material		MZ-K-14/6.5
	T-groove	80 – 100	Sensor claw, mounting material		MZ-K-16/6.5
<b>C- to T-groove adapter for magnetic field sensors</b>					
	C-groove			MZEC 9-26...	MZ-C-T-18
	C-groove			MZEC 9-18...	MZ-C-T-26
<b>Fastening adapter for dovetail cylinder</b>					
	T-groove				MZ-A-12/6.5
<b>Wedge fastener for pneumatic cylinder</b>					
	T-groove		1 x Allen key, 10 x Allen screws, 10 x washers, 10 x clamping blocks		MZ-KUS-M2

## Accessories for image processing & identification











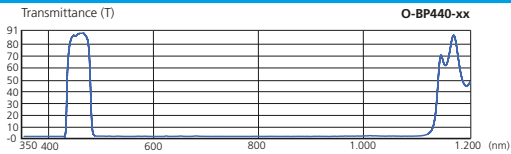

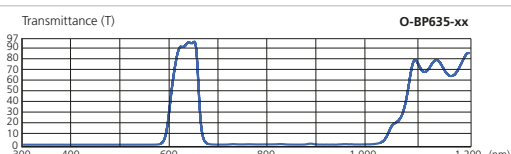
We offer a comprehensive assortment of accessories for our products in the area of image processing. From brackets for our lights to cables.

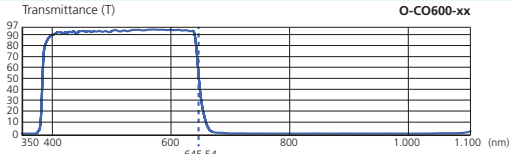
O-Z Filters, spacer rings and converters	229
BE-Z BV lighting accessories	231
CS-Z Vision sensor accessories	234

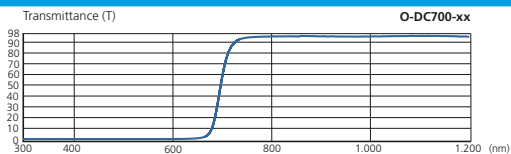
## O-Z FILTERS, SPACER RINGS AND CONVERTERS

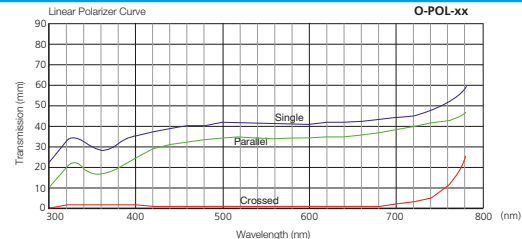
In the O-Z accessory series, we offer the appropriate functional extensions for our lenses. These include filters, spacer rings and converters.

	Wavelength	Transmission	Material Filter thread: Aluminum Filter: Glass	Mounting thread for additional filters	Filter thread M <sub>x</sub> pitch P (mm)	Product description
<b>Bandpass filter</b>						
		440 nm Blue	■		M27 x 0.5	0-BP440-27
					M30.5 x 0.5	0-BP440-30
					M37 x 0.5	0-BP440-37
		635 nm Red	■		M27 x 0.5	0-BP635-27
					M30 x 0.5	0-BP635-30
					M37 x 0.5	0-BP635-37
<b>Cutoff filter</b>						
		IR blocking filter open < 645 nm	■		M27 x 0.5	0-CO600-27
					M30.5 x 0.5	0-CO600-30
					M37 x 0.5	0-CO600-37
<b>Daylight blocking filter</b>						
		Daylight blocking filter open > 700 nm	■		M27 x 0.5	0-DC700-27
					M30.5 x 0.5	0-DC700-30
					M37 x 0.5	0-DC700-37
<b>Polarization filter with locking screw</b>						
			■	■	M27 x 0.5	0-POL-27
					M30.5 x 0.5	0-POL-30
					M37 x 0.5	0-POL-37

				Spacer distance (mm)	c-mount (ANSI) 1-32UN-2B / 1-32UN-2A	Product description
<b>Spacer rings</b>						
				0.5	■	0-ER-005
				1.0	■	0-ER-010
				2.0	■	0-ER-020
				5.0	■	0-ER-050
				10.0	■	0-ER-100
				20.0	■	0-ER-200
				30.0	■	0-ER-300
				40.0	■	0-ER-400
				50.0	■	0-ER-500
				Set	■	0-ET-5

				Magnification factor	c-mount (ANSI) 1-32UN-2B / 1-32UN-2A	For imagers up to 2/3"	Product description
<b>Converter</b>							
				1.5	■	■	0-1.5XNB
				2.0	■	■	0-2.0XNB
				2.5	■	■	0-2.5XNB
				4.0	■	■	0-4.0XNB



## BE-Z BV LIGHTING ACCESSORIES

In the BE-Z accessory series, we offer the appropriate functional extensions for our lighting. These include brackets, cables and viewing panes.

Various controllers are used as accessories for the operation of all externally flashable lighting for industrial image processing.

Technical data (typ.)	+20°C, 24 VDC
Service voltage	24 V DC ± 1
Trigger input	5 to 24 V DC potential-free, optocouplers
Trigger output	12V DC, push-pull, pnp, npn configurable (max. 150 mA)
Ready output	12V DC, push-pull, pnp, npn configurable (max. 150 mA)
Input power at 24VDC	Max. 55W
Protection class	III, operation on protective low voltage
Inverse polarity protection	In pairs by terminal group
Short-circuit protection	In pairs by terminal group
Operating display	LED: Green, LED: Yellow (flashing), LED: Red (fault)
Shock/vibration load	10 to 55 Hz / 1.0 mm / 30 g
Ambient temperature	0 to +40°C
Protection type	IP 40
Housing material	Aluminum anodized, PA 6.6 FR



	Average / Peak power consumption	LED constant current (configurable)	LED pulse current (configurable)	Pulse duration (configurable)	Pulse cycle time (configurable)	Pulse delay (configurable)	RS-485 point-to-point connection	Terminal strip	Product description
<b>Flash controller for flashable lighting</b>									
	< 2.5 A 6.0 A	0.1 to 1.8 A	0.1 to 20.0 A	10 μs to 50 ms	100 μs to 60 s	≥50 μs (0 to 2 A) ≥5 μs (2 to 20 A)	■	12-pin	BC-100-20A

Requirements for the power unit									
24VDC, 6A									

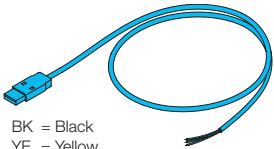
<b>Interface adapter 1.8m, RS485/USB</b>									
									
GND	BK = Black								
Data-(B)	YE = Yellow								
Data+(A)	OG = Orange								
									RS485-1.8-USB

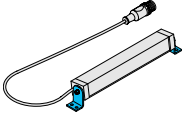
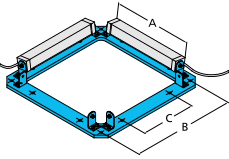
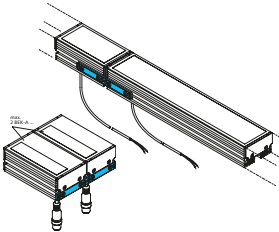
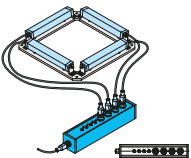
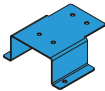
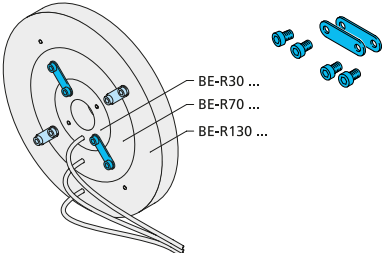
				Compatible with:								Product description		
				BE-A65 ...	BE-A130 ...	BE-A240 ...	BEK-A100 ...	BEK-A200 ...	BEK-A300 ...	BEK-A400 ...	BEK-A500 ...	BE-A100 ...	BE-A300 ...	
<b>Mounting bracket for barlights</b>														
	<ul style="list-style-type: none"> <li>Stepless adjustment</li> <li>Packing unit 2 pieces</li> </ul>			■	■	■								BW-BE 1-A
<b>Mounting frame for barlights</b>														
	<ul style="list-style-type: none"> <li>Stepless adjustment</li> <li>For up to four lights</li> <li>The bracket and mounting materials for four lights are included in the scope of delivery</li> </ul>			■										BE 1-A65-FRAMESET
					■									BE 1-A130-FRAMESET
						■								BE 1-A240-FRAMESET
<b>Mounting set for barlights</b>														
	<ul style="list-style-type: none"> <li>Crossbar to cascade two barlights</li> <li>Set consists of: Aluminum crossbars, anodized black (2 pcs.)</li> <li>Required screws and washers</li> </ul>						■	■	■	■	■	■	■	BEK-A-MOUNTINGSET
<b>Distributor box for barlights</b>														
	<ul style="list-style-type: none"> <li>Four M12 sockets, individually switchable</li> <li>Trigger signal, looped through</li> <li>Current-carrying capacity 4,000 mA</li> </ul>			■	■	■								BEV-200/4-IBS
<b>System holder for lighting</b>														
	65.0 x 65.5 x 25.0	Stainless steel (V2A)	1 adapter plate (BEK-F - CS 60), mounting material									■		HS-BE-FL-MP-VS-M3
<b>Mounting set for ring lighting</b>														
	<p>BE-R30 ... BE-R70 ... BE-R130 ...</p> <p>For connecting two lights of adjacent design sizes to a single unit. Set consists of two connecting elements and four M4x6 cheese-head screws. For installing all three lights into a single unit, two BE-R-MOUNTINGSETS are required.</p>													BE-R-MOUNTINGSET

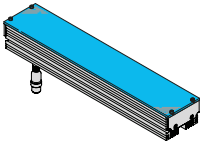
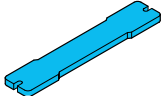
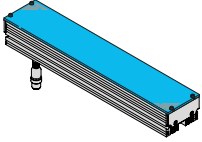
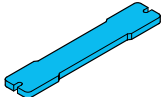
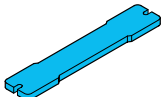
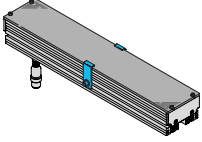
		Compatible with:										Product description	
		BE-A65 ...	BE-A130 ...	BE-A240 ...	BEK-A100 ...	BEK-A200 ...	BEK-A300 ...	BEK-A400 ...	BEK-A500 ...	BE-A100 ...	BE-A300 ...		
<b>Diffuser for barlights</b>													
	<ul style="list-style-type: none"> <li>Homogeneous light reduction</li> <li>Can be retrofitted quickly and easily</li> <li>Scratch-resistant safety screen</li> <li>Mounting materials included in scope of delivery</li> </ul>	113 mm			■					■	BEK-A100-DIF <sup>1)</sup>		
		213 mm				■						BEK-A200-DIF	
		313 mm					■					BEK-A300-DIF <sup>2)</sup>	
		413 mm						■				BEK-A400-DIF <sup>3)</sup>	
		513 mm							■			BEK-A500-DIF <sup>3)</sup>	
<b>Polarizer for barlights</b>													
	<ul style="list-style-type: none"> <li>PMMA</li> <li>Material thickness 3 mm</li> </ul>	79 mm	■								BE-A65-POL		
		139 mm		■								BE-A130-POL	
		249 mm			■							BE-A240-POL	
	<ul style="list-style-type: none"> <li>To reduce glare or highlights</li> <li>Can be retrofitted quickly and easily</li> <li>Scratch-resistant safety screen</li> <li>Mounting materials included in scope of delivery</li> <li>High-temperature resistant: For a pulse / pause ratio of the lighting, up to 100%</li> </ul>	113 mm			■					■	BEK-A100-POL <sup>1)</sup>		
		313 mm					■					■	BEK-A300-POL <sup>2)</sup>
		513 mm								■			BEK-A500-POL <sup>3)</sup>
<b>Safety screen for barlights</b>													
	<ul style="list-style-type: none"> <li>PC</li> <li>Material thickness 3 mm</li> <li>lenticular</li> </ul>	79 mm	■								BE-A65-LTK		
		139 mm		■								BE-A130-LTK	
		249 mm			■							BE-A240-LTK	
	<ul style="list-style-type: none"> <li>PMMA</li> <li>Material thickness 3 mm</li> <li>clear</li> </ul>	79 mm	■								BE-A65-CLR		
		139 mm		■								BE-A130-CLR	
		249 mm			■							BE-A240-CLR	
<b>Hold-down device set for barlights</b>													
	<ul style="list-style-type: none"> <li>For holding down attachment panels that have a length of 300 mm or longer</li> <li>Set consists of:                             <ul style="list-style-type: none"> <li>-Hold-down devices (2x)</li> <li>-Mounting material</li> </ul> </li> </ul>							■	■	■	■	BEK-A-NH	





<sup>1)</sup> Delivery does not include a BEK-A-NH hold-down device set

<sup>2)</sup> Delivery includes a BEK-A-NH hold-down device set

<sup>3)</sup> Delivery includes two BEK-A-NH hold-down device sets

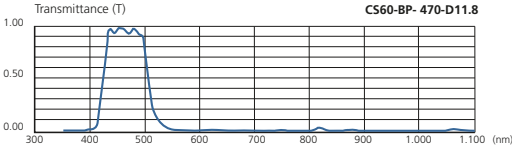
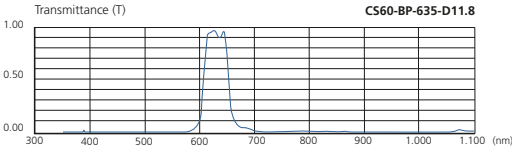
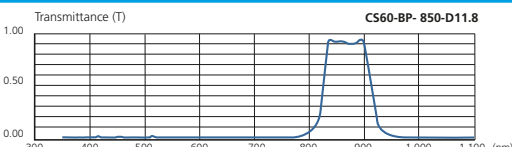

## CS-Z VISION SENSOR ACCESSORIES

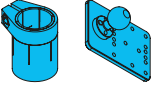

In the CS-Z accessory series, we offer the appropriate functional extensions for our Vision sensors. These include brackets, filters, Y cables and lens protective caps.

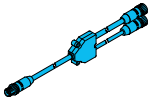

	Wavelength	Transmission	Housing material: Borofloat	Diameter (mm)	Product description
<b>Bandpass filter</b>					
 <p>Transmittance (T) <b>CS60-BP-470-D11.8</b></p>	470 nm Blue	435 - 490 nm (>85%), 350 - 400 / 550 - 1100 nm (<3%)	■	Ø 11.8	CS60-BP-470-D11.8
 <p>Transmittance (T) <b>CS60-BP-635-D11.8</b></p>	635 nm Red	615 - 645 nm (>85%), 350 - 570 / 700 - 1100 nm (<3%)	■	Ø 11.8	CS60-BP-635-D11.8
<b>Infrared filter</b>					
 <p>Transmittance (T) <b>CS60-BP-850-D11.8</b></p>	850 nm Infrared	840 - 900 nm (>85%), 350 - 780 / 960 - 1100 nm (<3%)	■	Ø 11.8	CS60-BP-850-D11.8
	Transmission	Material	Weight (g)	Component	Product description
<b>Diffuser for CS-60</b>					
	90 %	PVAL (optical film) PMMA (lens cover)	10	Diffuser	CS60-WINDOW-DIFFUS
<b>Optics lens cover polarizing film for CS-60</b>					
	40 %	PVAL (optical film) PMMA (lens cover)	10	Polarizer	CS60-WINDOW-POLAR
<b>Safety screen for CS-60</b>					
	92 %	PMMA (lens cover)	10	Safety screen	CS60-WINDOW

	Size	to be used for	Housing material	Scope of delivery	Product description
<b>Holding system for CS-60</b>					
	75.0 x 50.0 x 35.0 mm	Vision sensors CS-60	Aluminum	1 mounting plate (CS 60), 1 ball-shaped head, 1 ball housing, mounting material	HS-VS-CS60-MP-KK-M3

	Service voltage	Housing material	Protection type	Connection	Connection 2	Connection 3	Product description
<b>Distributor cable for CS-60</b>							
	< 30 V AC/DC	Plastic	IP 67	Connector, M12, 12-pin	Socket, M12, 12-pin	Socket, M12, 4-pin	CS60-Y-1/12-A

	Service voltage	Design	Ambient temperature during operation	Protection type	Connection	Connection 2	Product description
<b>Connecting cable for CS-60</b>							
	< 30 V AC/DC	Straight / straight	-25 to +85 °C	IP 65 / 67	Connector, 0.15 m / M12, 8-pin	Socket, M12, 8-pin	VSHM-Z-0.15/RJ45/RJ45-X
	< 30 V AC/DC	Angled	-5 to +80 °C (movable, fixed)	IP 67	Socket, M12, 12-pin dimensions of 12 x 0.14 mm <sup>2</sup>	flying leads	VKPM-W-5/12-A-CS60

	Ethernet	I/O	Coupling	Cable length (m)	Connector	Protection type	Cable material	Drag chain compatible for CS-60	Product description
<b>Ethernet cable for Vision Sensors</b>									
	■			5.0		IP 67	PUR		VKHM-W-5/RJ45

	Ethernet	I/O	Coupling	Cable length (m)	Connector	Protection type	Cable material	Drag chain compatible for CS-60	Product description
<b>I/O extension cables for Vision Sensors</b>									
		■		0.2		IP 67	PUR	■	VSHM-Z-0.2/4/VKM-Z/12-A-CS60

## Accessories for machine lighting & signal lights





di-soric offers optimal accessories, such as dimmers, assembly accessories, and diffusers for the machine and signal lighting portfolio.

MB-SB-Z Accessories for machine and signal lighting	237
SBT-Z Accessories for signal lights	237

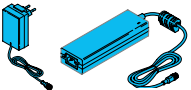
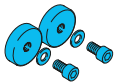

## MB-SB-Z ACCESSORIES FOR MACHINE AND SIGNAL LIGHTING

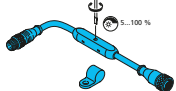
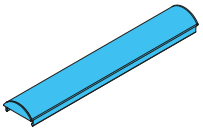
With the plug & play dimmer, the light intensity can be adapted as needed. Facing diffusers allow for largely subjective glare-reduction for the lighting. Magnetic and mechanical bracket systems open up a vast range of assembly options for lighting.

		Compatible with:	MB-N-12x-K-B3	MB-N-12x-K	MB-N-25x-K-B3	MB-N-25x-K	MB-N-48x-K-B3	MB-N-48x-K	MB-N-70x-K-B3	MB-N-70x-K	MB-N-91x-K-B3	MB-N-91x-K	MB-NP-250-K	MB-NP-480-K	Product description	
<b>Power supply for machine lighting</b>																
			■	■	■	■	■	■	■	■	■	■	■	■	PS-24V/0,9	
			■	■	■	■	■	■	■	■	■	■	■	■	DPS-24V/4,0	
<b>Magnetic holder set for machine lighting</b>																
	■ Adhesive force 3.6 kg (2x)		■	■											MB-MHS	
	■ Adhesive force 9.0 kg (2x)				■	■	■	■	■	■	■	■	■	■	MB-MHS-2	
<b>Mounting bracket for machine lighting</b>																
	■ Stepless adjustment		■	■	■	■	■	■	■	■	■	■	■	■	BW-MB	
<b>PWM dimmer for machine lighting</b>																
	■ Pulse width modulation ■ Dimming range 5 to 100 %			■	■	■	■	■	■	■	■	■			MB-DIM 2	
<b>Diffuser for machine and signal lighting</b>																
	<ul style="list-style-type: none"> <li>■ For homogeneous light reduction and illumination</li> <li>■ Simple installation by means of a locking groove</li> </ul>		■	■											MB-DIF-R-125	
					■	■										MB-DIF-R-250
							■	■								MB-DIF-R-480
									■	■						MB-DIF-R-700
											■	■				MB-DIF-R-910

## SBT-Z ACCESSORIES FOR SIGNAL LIGHTS

di-soric offers robust fasteners for installing signal lights.

		Product description
<b>Assembly flange for signal lights</b>		
	Simple assembly of the SBT-x, by screwing in	SBT-MF-M30
<b>Extension tube for signal lights</b>		
	Simple assembly of the SBT-x, by screwing in Cascadable through screwing several extension tubes into one another	SBT-VR-100-M30
<b>Mounting bracket for signal lights</b>		
	Adjustable, robust design	SBT-BW-M30

## Safety technology accessories

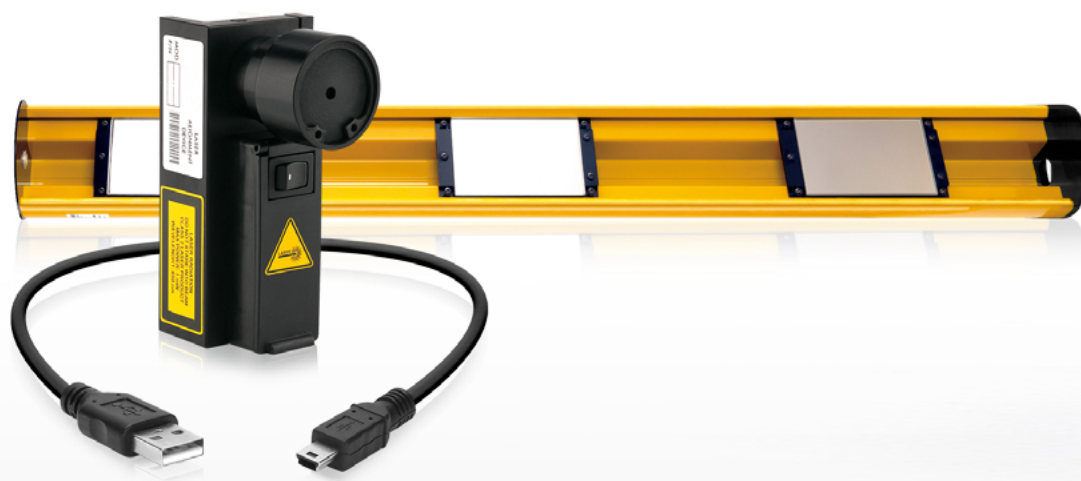

Tailored accessories for quick installation and commissioning round out the safety technology product range of di-soric. These accessories include connection and mounting technology as well as aids for adjusting and checking safety functions.

SL-Z-M mechanical

239

SL-Z-E Electrical

246



## SL-Z-M MECHANICAL

In terms of mechanical accessories, assembly columns, deflection mirrors, safety screens, test rods, laser alignment aids, and fastening accessories are available.

### Mounting columns

- Effortless installation and removal of the light curtains / grids with the option of easy height adjustment of the first beam
- Models with a rear PG11 connection are also available
- Columns made from extruded aluminum with adjustable angular orientation
- Steel base for floor mounting, with options for adjusting the vertical column axis
- Integrated spherical spirit level for checking correct vertical positioning
- Steel anchor bolts are included in the scope of delivery for the base

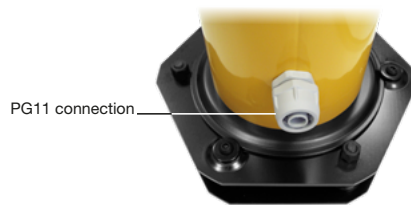

FMC-EBx



FMC-B12

### Mounting columns with deflection mirrors

- Pre-mounted deflection mirrors for creating circumferential protective field heights with up to 4 sides
- Models with pre-mounted and freely adjustable deflection mirrors for safety light grids with 2, 3 or 4 beams are also available
- Special models equipped with a protective anti-fragmentation film on the mirrors available upon request
- Columns made from extruded aluminum with adjustable angular orientation
- Steel base for floor mounting, with options for adjusting the vertical column axis
- Optical power reduction factor 15% for each mirror
- Integrated spherical spirit level for checking correct vertical positioning
- Steel anchor bolts are included in the scope of delivery for the base



FMC-SB



FMC-S

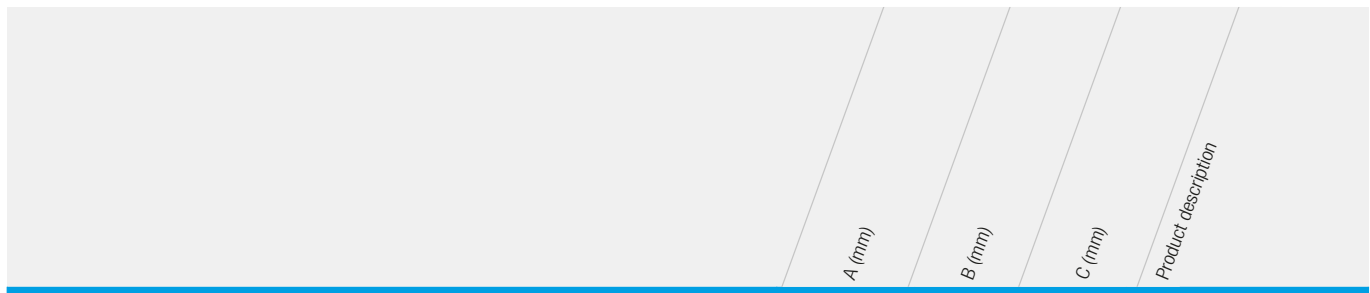

**Mounting columns with base**

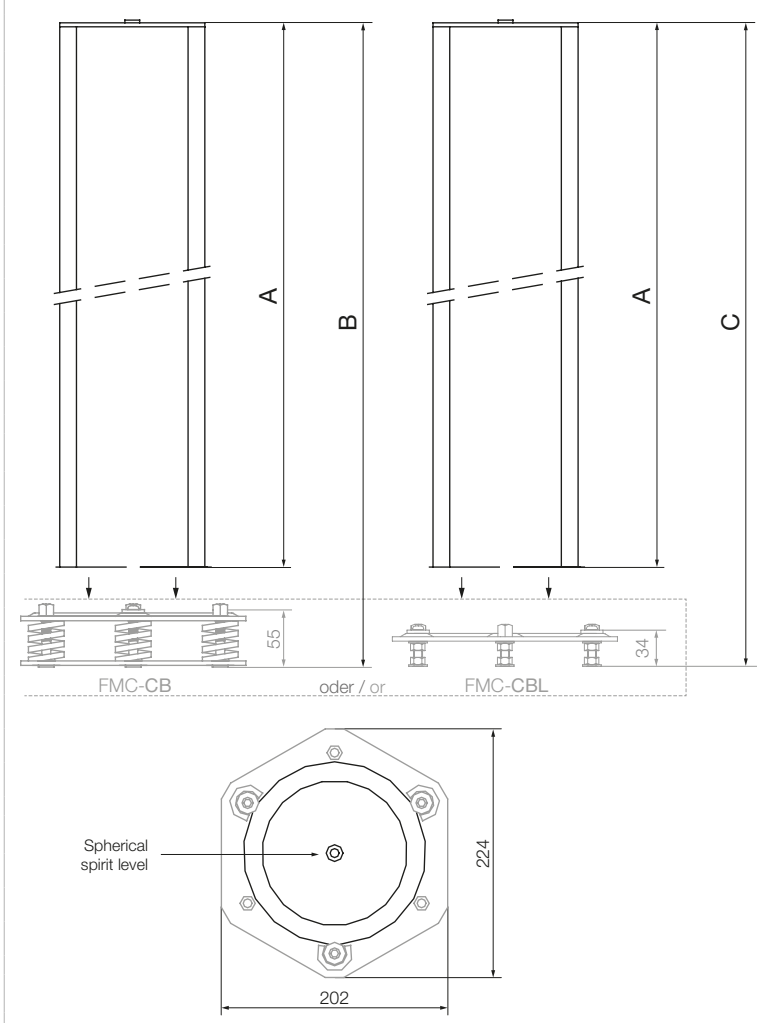

**for SLB / SLI light grids**

1,000	1,055	1,034	FMC-EB2
			FMC-EB2R
1,330	1,385	1,364	FMC-EB4
			FMC-EB4R

**for SLB / SLI light curtain**

1,670	1,725	1,704	FMC-EB1700
			FMC-EB1700R
1,970	2,025	2,004	FMC-EB2000
			FMC-EB2000R
1,200	1,255	1,234	FMC-B12

**With deflection mirrors for SLB / SLI light grids**

1,000	1,055	1,034	FMC-S2
			FMC-SB2
1,200	1,255	1,234	FMC-S3
			FMC-SB3
1,330	1,385	1,364	FMC-S4
			FMC-SB4

**With SLB / SLI deflection mirrors for light curtain**

1,670	1,725	1,704	FMC-S1700
1,970	2,025	2,004	FMC-S2000

**For SLM4 light grids**

1,000	1,055	1,034	FMC-SGB2
1,200	1,255	1,234	FMC-SGB3
1,330	1,385	1,364	FMC-SGB4

**For SLM4 light curtain**

1,670	1,725	1,704	FMC-SG1700
1,970	2,025	2,004	FMC-SG2000

The adjustable steel bases FMC-CB or FMC-CBL are required to ensure optimum mounting of mounting columns on the floor.



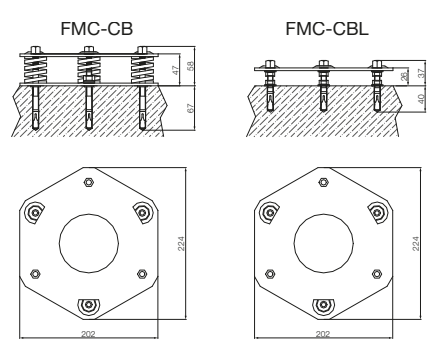

**Base for mounting columns**



Dimensions 202x224x58 mm	FMC-CB *
Dimensions 202x224x37 mm	FMC-CBL

Steel anchor bolts are included in the scope of delivery  
Order a base for each respective column.

\* The steel bases FMC-CB can be adjusted precisely.  
They consist of a double plate with steel springs for fine adjustment



		For light curtains / grids with...					Product description	
		Protective field height up to 1,210 mm	Protective field height up to 1,810 mm	2 beams	3 beams	4 beams		
<b>Mounting columns for SLB / SLI light curtains / grids</b>								
	Without PG11 connection			■			FMC-EB2	
					■	■	FMC-EB4	
		■					FMC-EB1700	
			■				FMC-EB2000	
	Without PG11 connection			■			FMC-EB2R	
					■	■	FMC-EB4R	
		■					FMC-EB1700R	
			■				FMC-EB2000R	
<b>Aluminum profile with fastening grooves</b>				■	■	■	FMC-B12	
<b>Mounting columns with deflection mirrors for SLB / SLI</b>								
	Premounted deflection mirror			■			FMC-S2	
					■		FMC-S3	
						■		FMC-S4
		■						FMC-S1700
		■					FMC-S2000	
	Freely adjustable deflection mirrors			■			FMC-SB2	
					■		FMC-SB3	
						■		FMC-SB4
<b>Base for mounting columns for SLB / SLI</b>								
	202 x 224 x 58 mm			■	■	■	FMC-CB	
	202 x 224 x 37 mm	■	■	■	■	■	FMC-CBL	

	A (mm)	B (mm)	Dimensions (mm)	For light curtains with a protective field height of (mm):	For Light curtains / grids			Product description
					2 beams	3 beams	4 beams	
	250	310	310 x 110 x 40	160				SP 100 S
	400	460	460 x 110 x 40	310				SP 300 S
	540	600	600 x 110 x 40	460				SP 400 S
	715	775	775 x 110 x 40	610	■			SP 600 S
	885	945	945 x 110 x 40	760				SP 700 S
	1,060	1,120	1,120 x 110 x 40	910		■		SP 900 S
	1,230	1,290	1,290 x 110 x 40	1,060			■	SP 1100 S
	1,400	1,460	1,460 x 110 x 40	1,210				SP 1200 S
	1,450	1,510	1,510 x 110 x 40	1,360				SP 1300 S
	1,600	1,660	1,660 x 110 x 40	1,510				SP 1500 S
	1,750	1,810	1,810 x 110 x 40	1,660				SP 1600 S
	1,900	1,960	1,960 x 110 x 40	1,810				SP 1800 S





**When using deflection mirrors, the following must be taken into account:**

- The working distance (range) is yielded from the sum of the lengths of all access sides of the monitored area.
- The maximum range between the transmitter and receiver is reduced by 15% for each mirror.
- The mirrors must be positioned so that the safety distance to the hazard zone can be maintained on each access side.
- If protective devices are implemented across long distances and are equipped with deflection mirrors on multiple sides, the LAD 4 laser alignment device should be used to align the light curtains / grids with each other quickly and correctly (see page 242).

		For light curtains / grids					
		up to protective field height (mm)	SLB / SLI	SLM4	Adjustment range up to	Pieces / set	Product description
<b>Standard brackets for light curtains / grids</b>							
	Each set includes the brackets required for transmitters and receivers. A set is already included in the scope of delivery for every light curtain / grid.	1,060	■		–	4	SA 4
		1,210	■		–	6	SA 6
<b>Adjustable brackets SFB 4... / SFB 6...</b>							
	Each set includes the brackets required for transmitters and receivers.	1,060	■		14°	4	SFB 4E
		1,060		■	14°	4	SFB 4SG
		1,210	■		14°	6	SFB 6E
		1,210		■	14°	6	SFB 6SG
<b>Adjustable brackets SFB E 180<sup>1)</sup></b>							
	Each set includes the brackets required for transmitters and receivers.	–	■		180°	4	SFB 180E
<b>Anti-vibration dampers<sup>2)</sup> for light curtains / grids SLB / SLI</b>							
	Each set includes the dampers necessary for transmitters and receivers.	160	■		–	4	SAV 4E
		260 to 1,060	■		–	8	SAV 8E
		1,210 to 1,810	■		–	12	SAV 12E

<sup>1)</sup>The brackets SFB E enable the light curtains / grids to be rotated along the longitudinal axis as well as allowing the vertical and horizontal position to be adjusted. The use of SFB E brackets is recommended for the alignment of light curtains / grids that operate over long distances or on multiple sides using deflection mirrors.

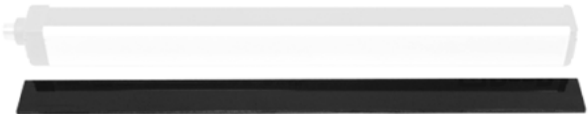
<sup>2)</sup>Unprotected safety light curtains / grids can be severely damaged if they are subjected to strong vibrations. For example, these vibrations occur with presses, weaving machines, etc. which can then be transferred to the attached light curtains / grids. In these cases, the use of vibration-damping brackets is highly recommended! SAV vibration dampers can easily reduce vibrations caused by such machines, thereby preventing damage to the light curtains / grids using deflection mirrors.

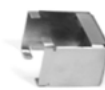
	For the protective field height (mm)	Product description
<b>Protective screens for SLB / SLI safety light curtains</b>		
<p>Safety screens</p>  <p>Fastening set</p>  End cap  Clamps 	160	PSE 150
	310	PSE 300
	460	PSE 450
	610	PSE 600
	760	PSE 750
	910	PSE 900
	1,060	PSE 1050
	1,210	PSE 1200
	1,360	PSE 1350
	1,510	PSE 1500
1,660	PSE 1650	
1,810	PSE 1800	
<b>Safety screens for safety light grids</b>		
Safety screen set for 2-beam light grid	510	PSE 2B
Safety screen set for 3-beam light grid	810	PSE 3B
Safety screen set for 4-beam light grid	910	PSE 4B
<b>Fastening set for PSE safety screens</b>		
Stainless steel clamps and end caps for safety screens		SFS E

The laser alignment aid makes it possible to align safety light curtains / grids quickly and easily with the help of a visible red light laser. With this product, safety light curtains / grids which are used across large distances or on several sides using deflection mirrors can be perfectly aligned.



Technical data (typ.)	+20 °C, 24 VDC
Emitted light	Red-light laser, 650 nm
Laser safety class	II (EN 60825-1)
Operating distance	100 m
Laser beam divergence	< 0.5 mrd
Laser power	1,000 µW
Service voltage	3V DC
Power supply	2x 1.5 V alkaline batteries type AAA
Housing material	Plastic
Fastening type	Quick fastening to the light curtain / grid or the mounting column
Dimensions HxLxD	117 x 48 x 80 mm

### Laser alignment aid

Dimensions in mm:

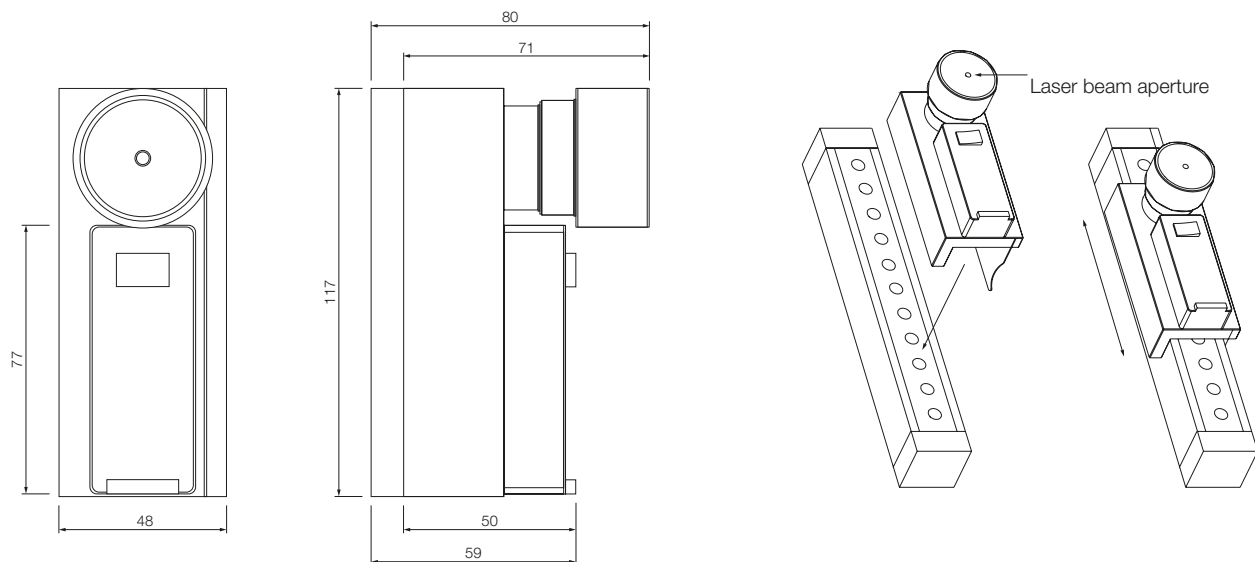







LAD 4

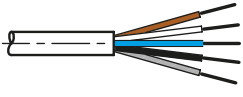

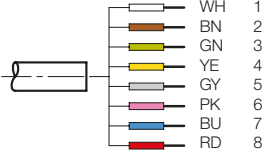

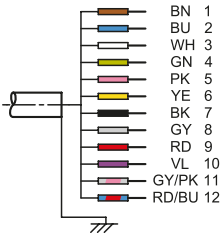

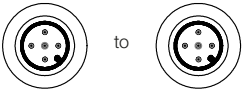
	For light curtains with resolution (mm)	Diameter (mm)	Product description
<b>Test rods for light curtains</b>	14 mm	Ø 14	TR 14
	20 mm	Ø 20	TR 20
	30 mm	Ø 30	TR 30
	40 mm	Ø 40	TR 40
	50 mm	Ø 50	TR 50

## SL-Z-E ELECTRICAL

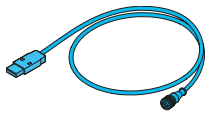
In terms of electrical accessories, a wide variety of connection cables, connecting cables and field-attachable plug connectors are available for individual industrial installations.

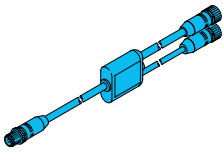
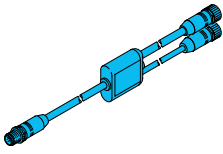
		straight	angled	Cable length (m)	Product description
<b>Connection cable for SLB2 ... SLBx4... and for SLI2..., SLIx4... SLM4 transmitters</b>					
	 <p>M12, 5-pin socket, at open end</p> <ul style="list-style-type: none"> <li>BN 1</li> <li>WH 2</li> <li>BU 3</li> <li>BK 4</li> <li>GY 5</li> </ul>	■		5	CD 5
				10	CD 10
				15	CD 15
				20	CD 20
				25	CD 25
		■		5	CD 95
				10	CD 910
				15	CD 915
<b>Connection cable for SLI2..., SLIx4... receivers</b>					
	 <p>M12, 8-pin socket, at open end</p> <ul style="list-style-type: none"> <li>WH 1</li> <li>BN 2</li> <li>GN 3</li> <li>YE 4</li> <li>GY 5</li> <li>PK 6</li> <li>BU 7</li> <li>RD 8</li> </ul>	■		5	C8D 5
				10	C8D 10
				15	C8D 15
				25	C8D 25
				40	C8D 40
		■		5	C8D 95
				10	C8D 910
				15	C8D 915
<b>Connection cable for SLM4 receivers</b>					
	 <p>M12, 12-pin socket, at open end</p> <ul style="list-style-type: none"> <li>BN 1</li> <li>BU 2</li> <li>WH 3</li> <li>GN 4</li> <li>PK 5</li> <li>YE 6</li> <li>BK 7</li> <li>GY 8</li> <li>RD 9</li> <li>VL 10</li> <li>GY/PK 11</li> <li>RD/BU 12</li> </ul>	■		3	CS12D3
				5	CS12D5
				10	CS12D10
				15	CS12D15
				20	CS12D20
<b>Connection cable between SLI2..., SLIx4... master and slave</b>					
	 <p>M12, 5-pin socket to M12, 5-pin socket</p>	■		0.3	CDS 03
				3	CJBE 3
				5	CJBE 5
				10	CJBE 10
				25	CJBE 25

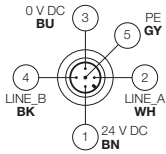

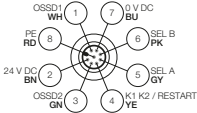
			straight	angled	Cable length (m)	Product description
<b>Connection cable between SLM4PO and PC</b>						
		Socket M12, 5-pin, to USB, type A plug	■		2	CS12 USB
<b>T-piece for muting arms MZ-T4P, transmitter</b>						
		Connector M12, 5-pin,(1x) socket M12, 5-pin,( 2x)	■		0.4	CSY12-TX
<b>T-piece for MZ-T4P muting arms, Receiver</b>						
		Connector M12, 5-pin,(1x) socket M12, 5-pin,( 2x)	■		0.4	CSY12-RX
<b>Field-attachable plug connector for SLB2..., SLBx4... and for SLI2..., SLIx4... SLM4 transmitters</b>						
	 <p>0 V DC BU 3 PE GY 5 LINE_B BK 4 LINE_A WH 2 24 V DC BN 1</p>	M12 socket, 5-pin, with screw terminals and PG9 screw connection	■			CDM 9
			■			CDM 99
<b>Field-attachable plug connector for SLI2..., SLIx4... receivers</b>						
	 <p>OSSD1 WH 1 7 0 V DC BU 8 PE RD 8 SEL_B PK 6 24 V DC BN 2 SEL_A GY 5 OSSD2 GN 3 K1 K2 / RESTART YE 4</p>	Socket M12, 8-pin, with screw terminals and PG9/11 screw connection	■			C8D M 11

## NOTES

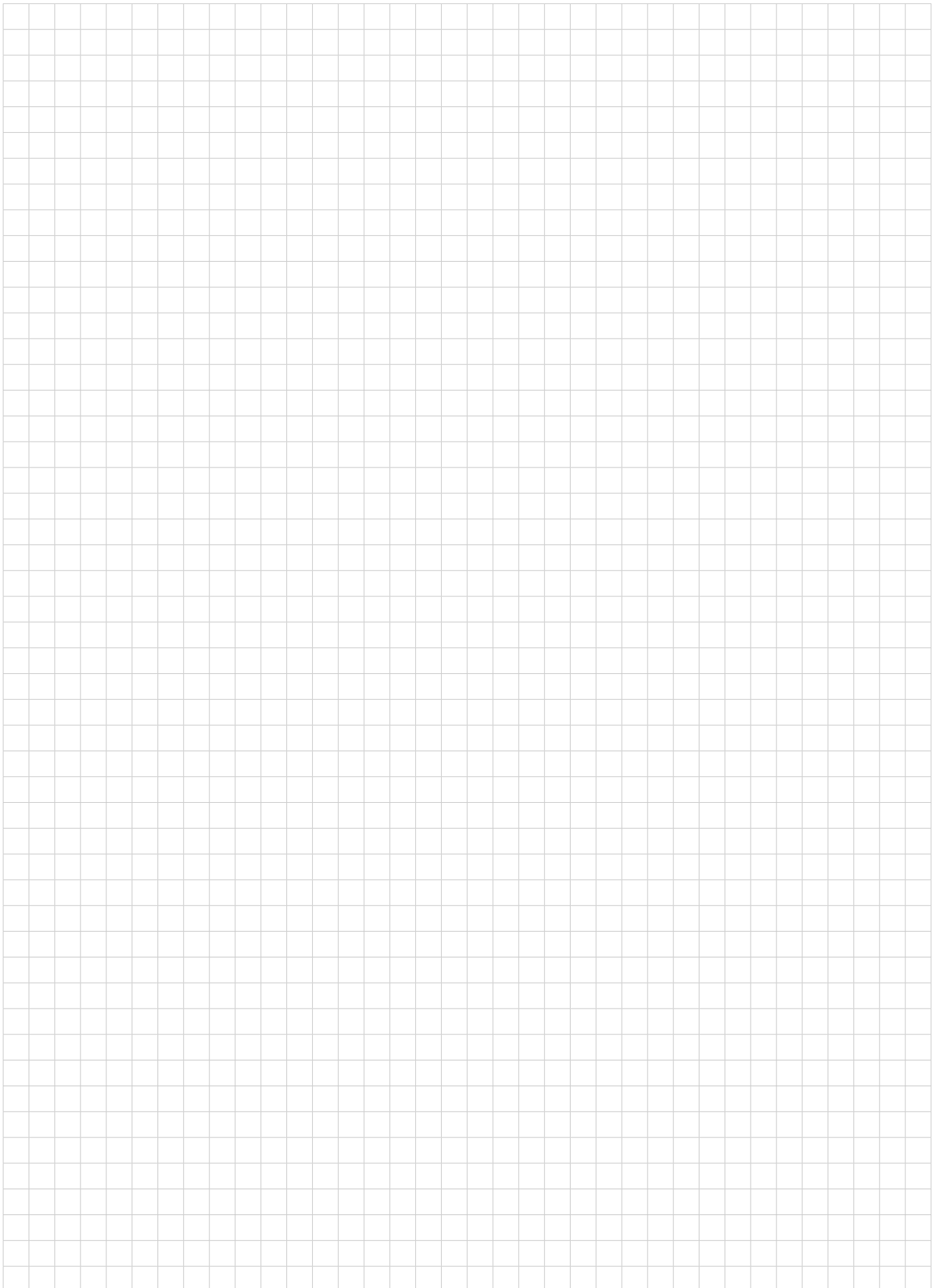

# INDEX SERIES

BE-B Barlights	155	O-40 Standard	52
BE-D Dark field lights	162	O-50 Metal	53
BE-F Area lights	153	O-81 Laser	54
BE-K Coaxial lights	161	OBS Optical motion sensors	133
BE-P Spotlights	158	O-C lenses C-mount	149
BE-R Ringlights	159	O-D4	58
BE-Z BV lighting accessories	231	OGL	75
CS-60	137	OGLL Laser	77
CS-Z Vision sensor accessories	234	OGLP Dirt-resistant	76
FS-10 Compact	109	OGU	67
FS-50 Extended	109	OGUL Laser	70
FS-100 Advanced	109	OGUP Dirt-resistant	69
FS-Z Color sensor accessories	222	OGU Stainless steel	71
ID-10 Compact	145	OGUTI Optical	125
ID-80 Standard	145	OGUZ Special Designs	73
ID-100 Advanced	145	OGWSD Frame design	79
ID-200 Hammer	145	OGWTI Open fork design	79
ID-Z Accessories Handheld ID Reader	146	OG-Z Accessories for fork light barriers	73
INA Analog	30	OK-50	111
INC Advanced	25	OLV-G Amplifier	103
INE Extended	18	OLV-K Amplifier	93
INF Food & beverage	32	O-M5	55
INH High-temperature resistant	31	O-M8	55
INM-100 Miniature	14	O-M18E Extended	58
INM-300 Miniature Extended	16	O-M18 Standard	56
INN Namur	34	OP-50	91
INP High-pressure resistant	29	OP-M12	89
INS-100 Standard	9	OP-Q12	90
INS-200 Standard 2-Sn	11	O-Q10 Miniature	54
INU Universal voltage	35	O-S Lenses S-mount	150
INW Full metal extended	26	O-Z Filters, spacer rings and converters	229
INZ Special applications	36	O-Z-M Mechanical accessories for light barriers and light sensors	59
IRB Standard	39	O-Z-REF Reflectors - reflective films	221
IRDB wire break sensor	43	PS-30 2D Laser profile sensor	141
IRD Dynamic	42	RS Radar sensors	134
IR Static	40	SBP-RGB 1-Segment IOL signal lights	171
IR-Z Accessories for Inductive ring sensors	43	SB-RGB Multi-Segment IOL signal lighting	167
ISDP Dynamic	45	SBT-F Multi-Segment Fixed Color Signal Columns	169
IS Static	45	SBT-RGB Multi-Segment IOL Signal Columns	170
KDC Standard	121	SBT-Z Accessories for signal lights	237
KL plastic fiber-optics	94	SL-4M Muting safety light curtains / grids, type 4	184
KLS-Z Plastic fiber-optic sensor accessories	226	SL-4 Safety light curtains / grids, type 4	176
KNS Extended	119	SL-Z-E Electrical	246
KSSTI Capacitive	127	SL-Z-M mechanical	239
LA Switching	81	SR safety relay / switching devices	190
LAT-45 Long range	61	UGUTI Ultrasonic	126
LAT-52 Compact	62	USGT	117
LAT-61 Precise	64	US-M8	113
LAT-Z Accessories for optical distance sensors	65	US-M12	113
LI-A Evaluation electronics for LI series	87	US-M18	115
LI Measuring	84	US-M30	116
LLGT Measuring	72	US-Q12	114
LVHT-52 Compact	63	US-Z Accessories for ultrasonic barriers/sensors	117
MA ... / MZ Muting arms	185	WRB Glass fiber optics	103
MB-N Machine lighting flat	165	Z-AT-ALE Connection cables	195
MB-NP Protected machine lighting	166	Z-AT-AST Adapter plugs	198
MB-RGBW Machine lighting with status indicator	166	Z-AT-SVK Field-attachable plug connectors	200
MB-R Machine lighting semicircular	165	Z-AT-VLE Connecting cables	197
MB-SB-Z Accessories for machine and signal lighting	237	Z-PP-IOL-M IO-Link Master	217
MODSI Safety control system	191	Z-PP-IOL-P IO-Link Portable	218
MZEC Cylinder sensors C-groove	129	Z-PP-ST Sensor tester	219
MZES gripper sensors	131	Z-SA-FA Function adapters	203
MZET Cylinder sensors T-groove	130	Z-SA-LV Logic distributors	205
MZE-Z Magnetic field sensor accessories	227	Z-UBT-KL-MS Assembly system for clamping brackets	207
O-20 Miniature	47	Z-UBT-KL-PH Product bracket for clamping bracket	210
O-21 Miniature	48	Z-UBT-KU-MS Assembly system for ball system	213
O-30 Universal	50	Z-UBT-KU-PH Product bracket for ball system	213
O-40E Extended	52		

**SOLUTIONS. CLEVER. PRACTICAL.**

### **di-soric Headquarters**

**Germany:** di-soric GmbH & Co. KG | Steinbeisstrasse 6 | 73660 Urbach  
Phone +49 71 81 98 79-0 | Fax +49 71 81 98 79-179 | [info@di-soric.com](mailto:info@di-soric.com)

### **di-soric Subsidiaries**

**Austria:** di-soric GmbH & Co. KG | Phone +43 7228 72 366 | [info.at@di-soric.com](mailto:info.at@di-soric.com)

**China:** di-soric Industrial Automation (Suzhou) Co. Ltd. | Phone +86 512 6260 9518 | [info@di-soric.cn](mailto:info@di-soric.cn)

**France:** di-soric SAS | Phone +33 476 61 65 90 | [info.fr@di-soric.com](mailto:info.fr@di-soric.com)

**Singapore:** di-soric Pte. Ltd. | Phone +65 6694 7866 | [info.sg@di-soric.com](mailto:info.sg@di-soric.com)

**The Netherlands:** di-soric B.V. | Phone +31 413 33 13 91 | [info.nl@di-soric.com](mailto:info.nl@di-soric.com)

For further information visit [www.di-soric.com/international](http://www.di-soric.com/international)

**[www.di-soric.com](http://www.di-soric.com)**